







PROYECTO Marco de Colmena	CREADO POR A. PARDO	APROBADO POR			
NOMBRE DE PIEZA BEE HIVE FRAMES	CÓDIGO 1	TIPO DE DOCUMENTO ASSEMBLY	MATERIAL WOOD		
 <small>OPEN SOURCE ECOLOGY GERMANY</small>	LICENCIA 	NOMBRE DE ARCHIVO BEE HIVE FRAMES.iam	VERSION 1.0	CANTIDAD 1	
		ESCALA 1 / 8	HOJA 1/	FECHA 04-10-2020	

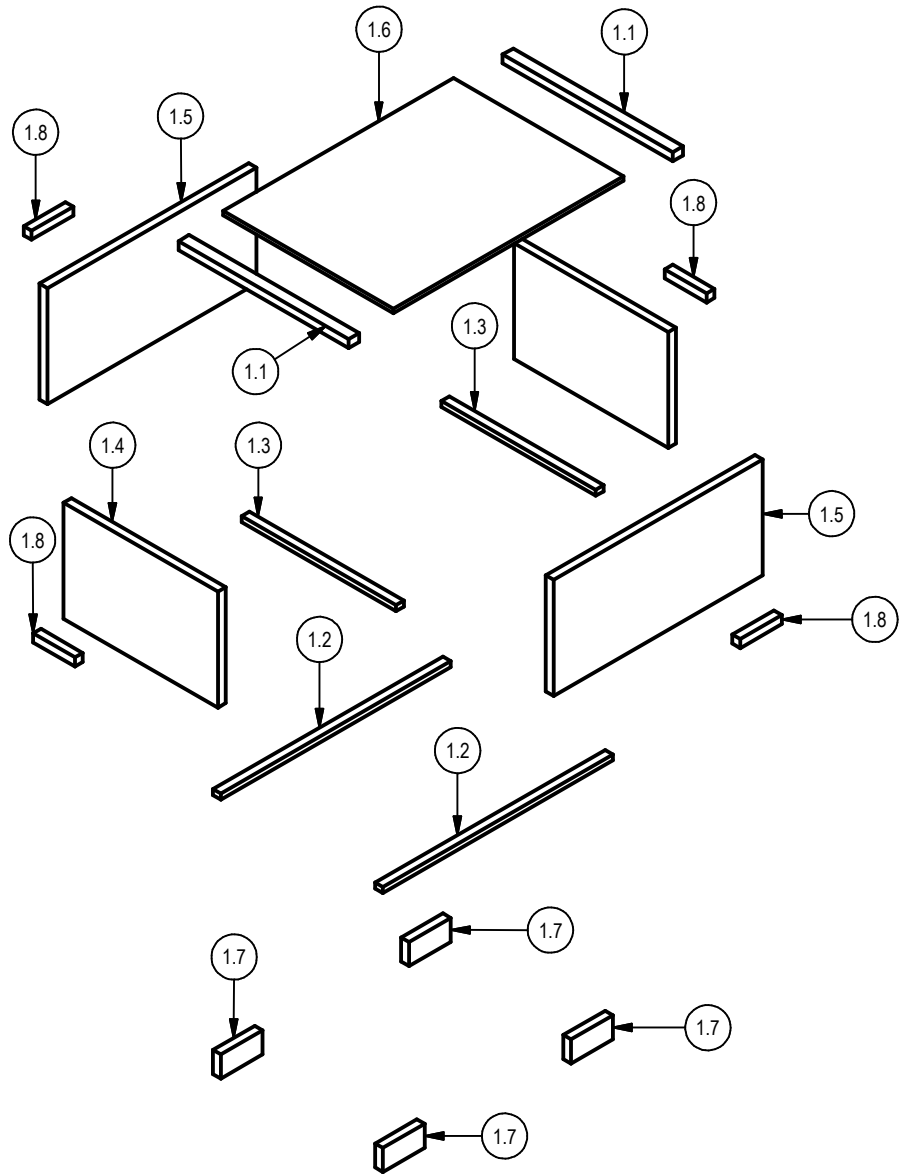

PARTS LIST						
POS.	POS. OLD	CANT	NOMBRE DE PIEZA	NOMBRE DE ARCHIVO	TIPO PZA	ESPECIFICACIONES
1		1	BEE HIVE FRAMES	BEE HIVE FRAMES.iam	ASSEMBLY	
1.1		1	PARTS LIST	PARTS LIST.iam	ASSEMBLY	
1.2		1	BROOD CHAMBER	BROOD CHAMBER.iam	ASSEMBLY	
1.3		2	BROOD CHAMBER A	BROOD CAMBER A.ipt	PART	
1.4		2	BROOD CHAMBER B	BROOD CHAMBER B.ipt	PART	
1.5		2	BROOD CHAMBER C	BROOD CHAMBER C.ipt	PART	
1.6		2	BROOD CHAMBER D	BROOD CHAMBER D.ipt	PART	
1.7		2	BROOD CHAMBER E	BROOD CHAMBER E.ipt	PART	
1.8		1	BROOD CHAMBER F	BROOD CHAMBER F.ipt	PART	
1.9		4	BROOD CHAMBER G	BROOD CHAMBER G.ipt	PART	
1.10		4	BROOD CHAMBER H	BROOD CHAMBER H.ipt	PART	
2		1	FRAME	FRAME.iam	ASSEMBLY	
2.1		1	FRAME A	FRAME A.ipt	PART	
2.2		2	FRAME B	FRAME B.ipt	PART	
2.3		1	FRAME C	FRAME C.ipt	PART	
2.4		2	FRAME D	FRAME D.ipt	PART	

PROYECTO Marco de Colmena	CREADO POR A. PARDO	APROBADO POR			
NOMBRE DE PIEZA BEE HIVE FRAMES	CÓDIGO 1.1	TIPO DE DOCUMENTO ASSEMBLY	MATERIAL WOOD / STEEL METAL		
	LICENCIA 	NOMBRE DE ARCHIVO PARTS LIST BEE HIVE FRAMES.iam	VERSION 1.0	CANTIDAD 1	
		ESCALA 1 / 20	HOJA 2/16	FECHA 01-10-2020	



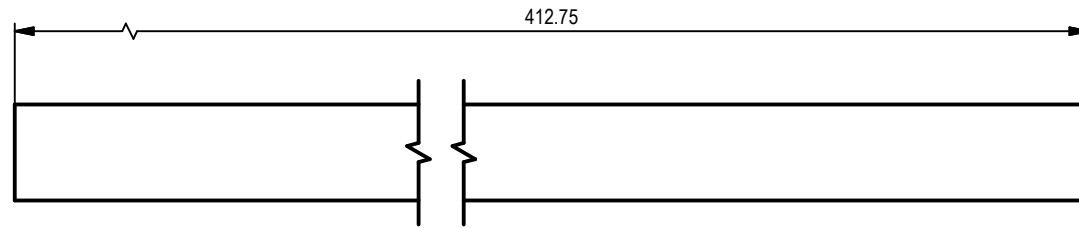
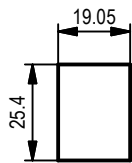
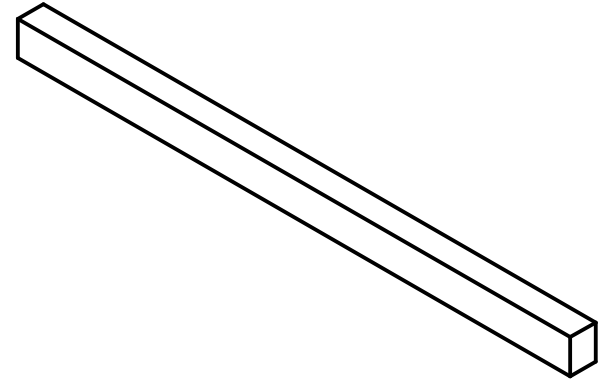

PROYECTO Marco de Colmena	CREADO POR A. PARDO	APROBADO POR		
NOMBRE DE PIEZA BROOD CHAMBER	CÓDIGO 1.2	TIPO DE DOCUMENTO ASSEMBLY	MATERIAL WOOD	
 <small>OPEN SOURCE ECOLOGY GERMANY</small>	LICENCIA 	NOMBRE DE ARCHIVO BROOD CHAMBER.iam	VERSION 1.0	CANTIDAD 1
		ESCALA 1 / 13	HOJA 1/16	FECHA 01-10-2020



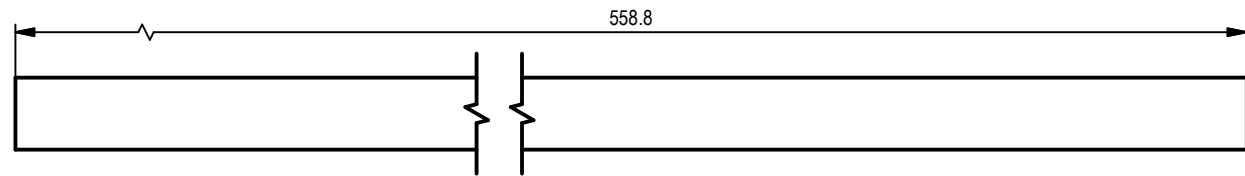
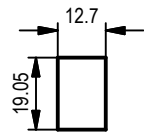
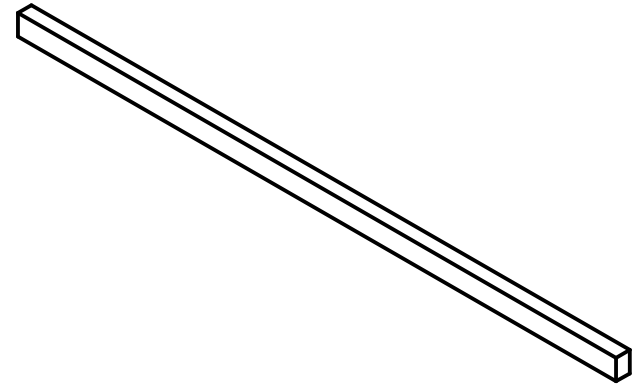

PROYECTO Marco de Colmena	CREADO POR A. PARDO	APROBADO POR			
NOMBRE DE PIEZA BROOD CHAMBER A	CÓDIGO 1.3	TIPO DE DOCUMENTO PART	MATERIAL WOOD		
	LICENCIA 	NOMBRE DE ARCHIVO BROOD CHAMBER A.ipt	VERSION 1.0	CANTIDAD 1	
		ESCALA 1 / 2	HOJA 4/16	FECHA 24-09-2020	



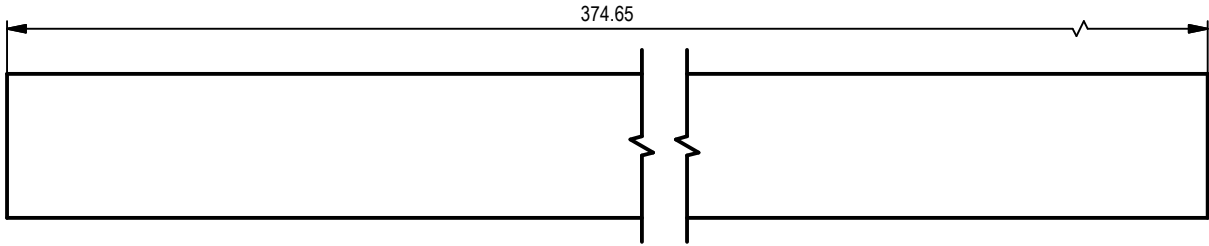
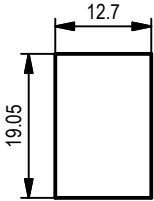
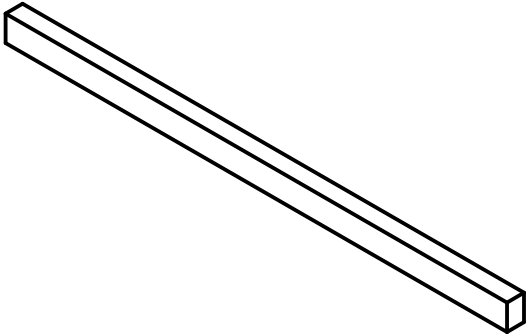

PROYECTO Marco de Colmena	CREADO POR A. PARDO	APROBADO POR		
NOMBRE DE PIEZA BROOD CHAMBER B	CÓDIGO 1.4	TIPO DE DOCUMENTO PART	MATERIAL WOOD	
	LICENCIA 	NOMBRE DE ARCHIVO BROOD CHAMBER B.ipt	VERSION 1.0	CANTIDAD 1
		ESCALA 1 : 2	HOJA 5/16	FECHA 24-09-2020



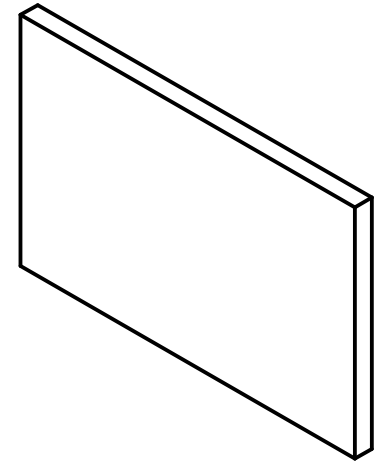
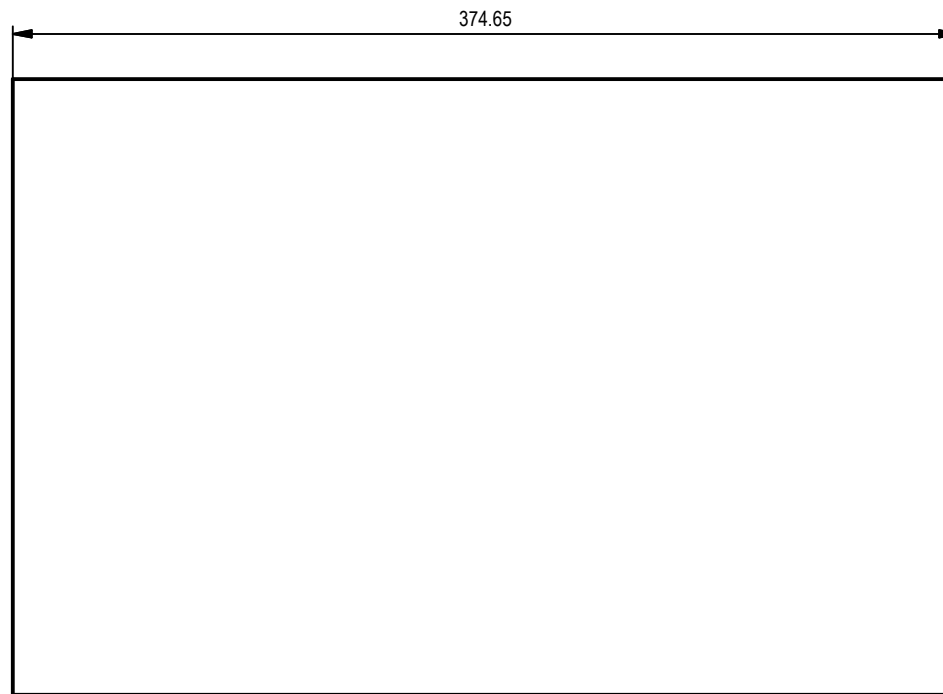
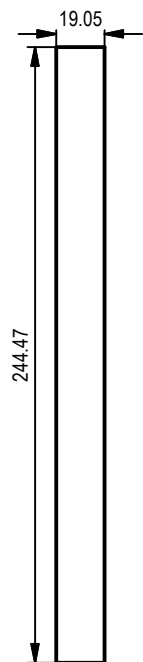

PROYECTO Marco de Colmena	CREADO POR A. PARDO	APROBADO POR		
NOMBRE DE PIEZA BROOD CHAMBER C	CÓDIGO 1.5	TIPO DE DOCUMENTO PART	MATERIAL WOOD	
	LICENCIA 	NOMBRE DE ARCHIVO BROOD CHAMBER C.ipt	VERSION 1.0	CANTIDAD 1
		ESCALA 1:1	HOJA 6/16	FECHA 24-09-2020



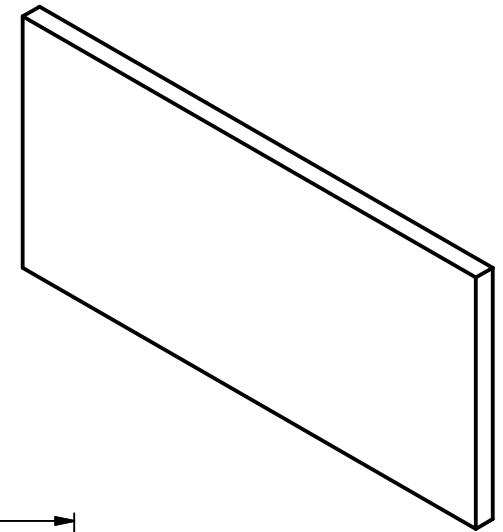
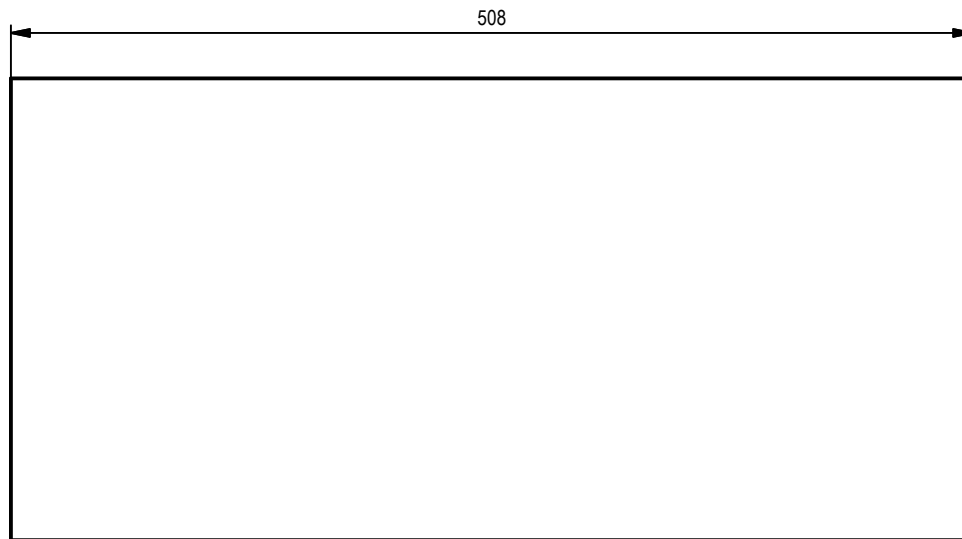
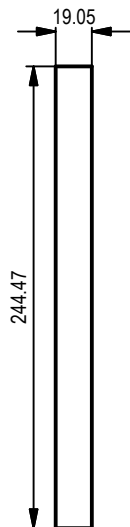

PROYECTO Marco de Colmena	CREADO POR A. PARDO	APROBADO POR			
NOMBRE DE PIEZA BROOD CHAMBER D	CÓDIGO 1.6	TIPO DE DOCUMENTO PART	MATERIAL WOOD		
 <small>OPEN SOURCE ECOLOGY GERMANY</small>	LICENCIA 	NOMBRE DE ARCHIVO BROOD CHAMBER D.ipt	VERSION 1.0	CANTIDAD 1	
		ESCALA 1 / 3	HOJA 7/16	FECHA 24-09-2020	



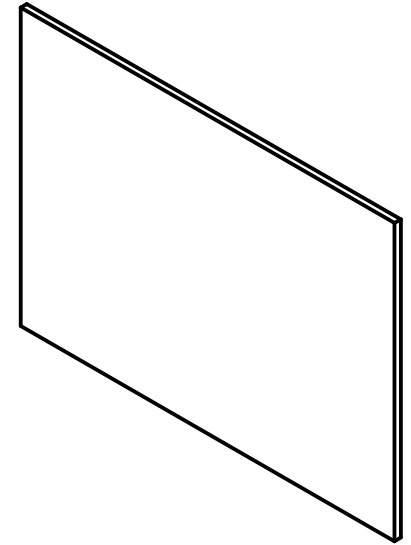
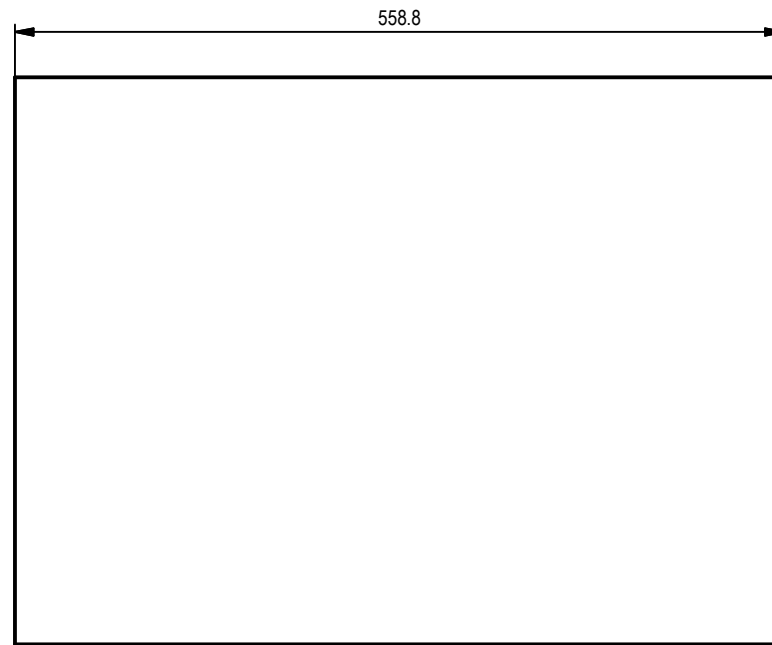
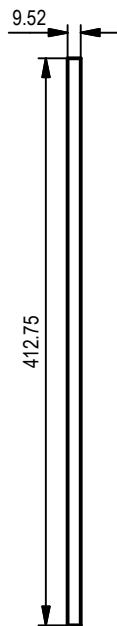

PROYECTO Marco de Colmena	CREADO POR A. PARDO	APROBADO POR		
NOMBRE DE PIEZA BROOD CHAMBER E	CÓDIGO 1.7	TIPO DE DOCUMENTO PART	MATERIAL WOOD	
 <small>OPEN SOURCE ECOLOGY GERMANY</small>	LICENCIA 	NOMBRE DE ARCHIVO BROOD CHAMBER E.ipt	VERSION 1.0	CANTIDAD 1
		ESCALA 1 : 4	HOJA 8/16	FECHA 24-09-2020



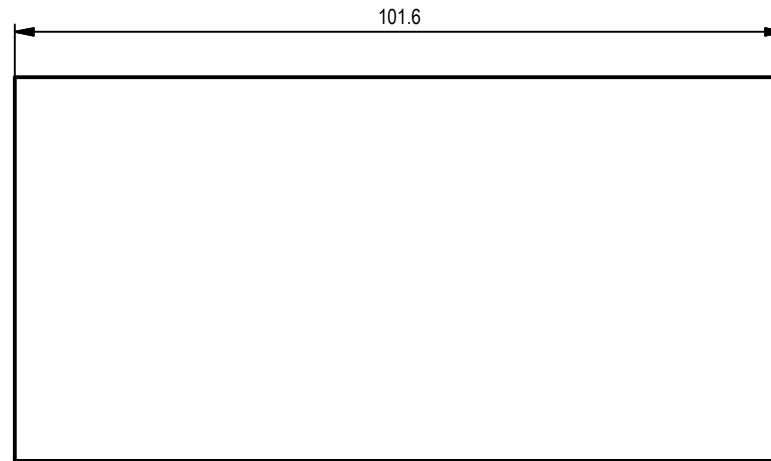
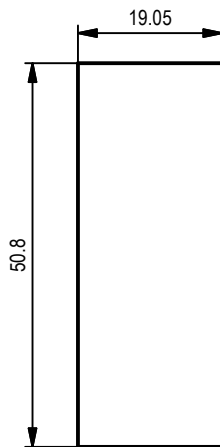
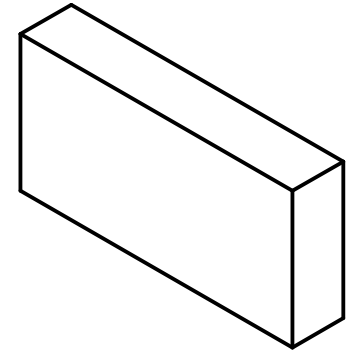

PROYECTO Marco de Colmena	CREADO POR A. PARDO	APROBADO POR		
NOMBRE DE PIEZA BROOD CHAMBER F	CÓDIGO 1.8	TIPO DE DOCUMENTO PART	MATERIAL WOOD	
 <small>OPEN SOURCE ECOLOGY GERMANY</small>	LICENCIA 	NOMBRE DE ARCHIVO BROOD CHAMBER F.ipt	VERSION 1.0	CANTIDAD 1
		ESCALA 1 : 5.5	HOJA 9/16	FECHA 24-09-2020



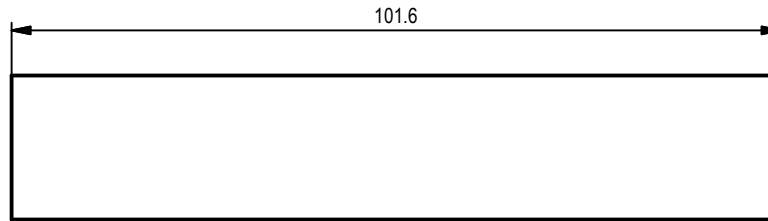
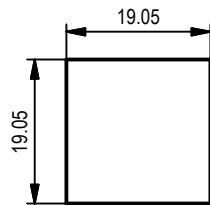
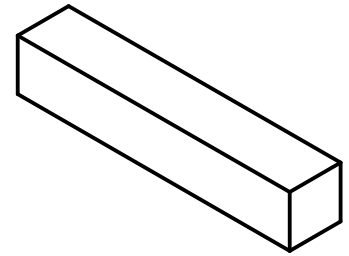

PROYECTO Marco de Colmena	CREADO POR A. PARDO	APROBADO POR			
NOMBRE DE PIEZA BROOD CHAMBER G	CÓDIGO 1.9	TIPO DE DOCUMENTO PART	MATERIAL WOOD		
	LICENCIA 	NOMBRE DE ARCHIVO BROOD CHAMBER G.ipt	VERSION 1.0	CANTIDAD 1	
		ESCALA 1 : 1	HOJA 10/16	FECHA 24-09-2020	



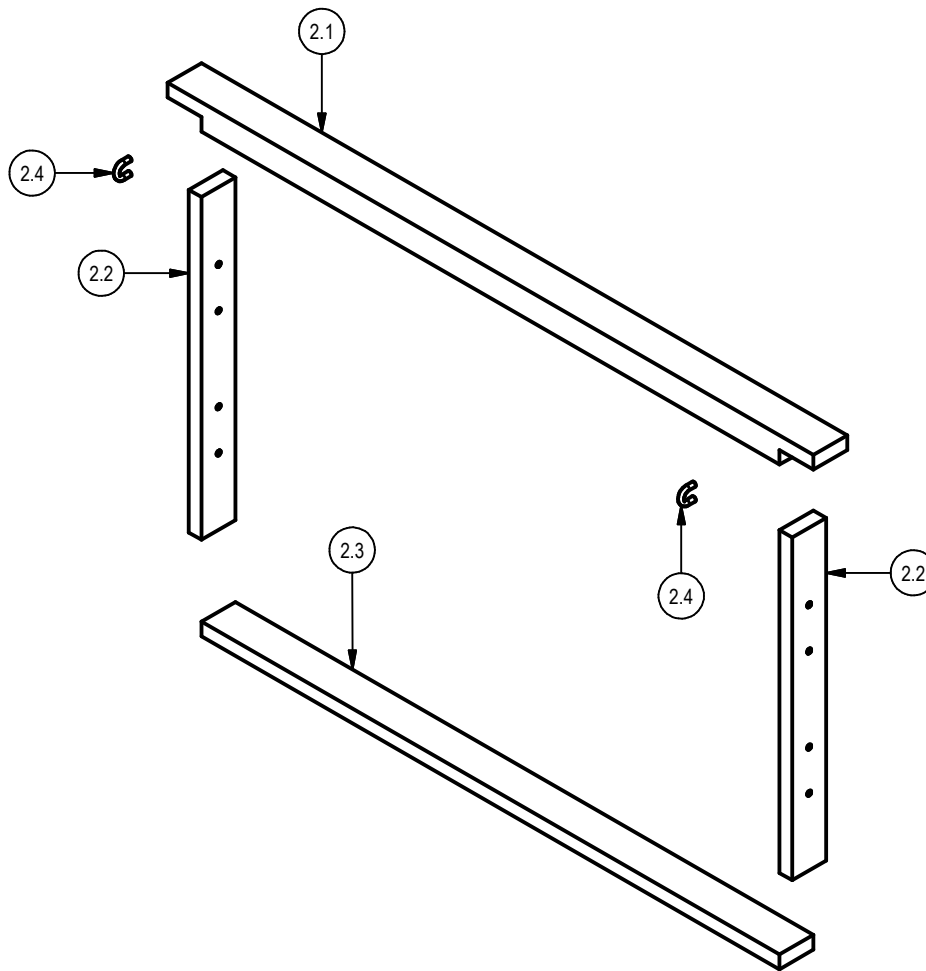

PROYECTO Marco de Colmena	CREADO POR A. PARDO	APROBADO POR			
NOMBRE DE PIEZA BROOD CHAMBER H	CÓDIGO 1.10	TIPO DE DOCUMENTO PART	MATERIAL WOOD		
	LICENCIA		NOMBRE DE ARCHIVO BROOD CHAMBER H.ipt	VERSION 1.0	CANTIDAD 1
			ESCALA 1 : 1	HOJA 11/16	FECHA 01-10-2020



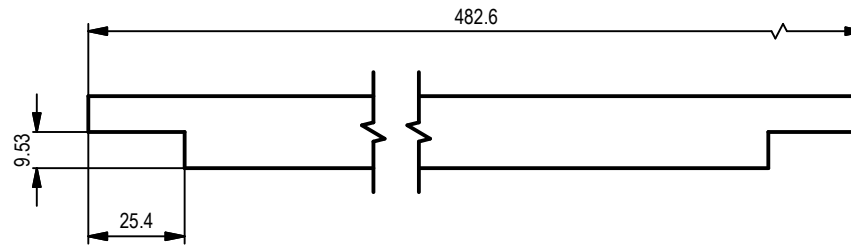
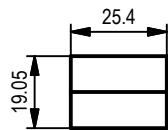
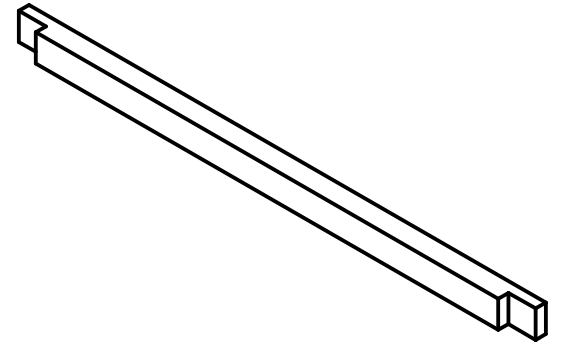

PROYECTO Marco de Colmena	CREADO POR A. PARDO	APROBADO POR		
NOMBRE DE PIEZA FRAME	CÓDIGO 2	TIPO DE DOCUMENTO ASSEMBLY	MATERIAL WOOD/STEEL METAL	
 OPEN SOURCE ECOLOGY GERMANY	LICENCIA 	NOMBRE DE ARCHIVO FRAME.iam	VERSION 1.0	CANTIDAD 1
		ESCALA 1 / 4	HOJA 12/16	FECHA 01-10-2020



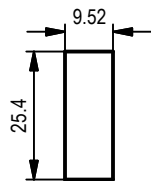
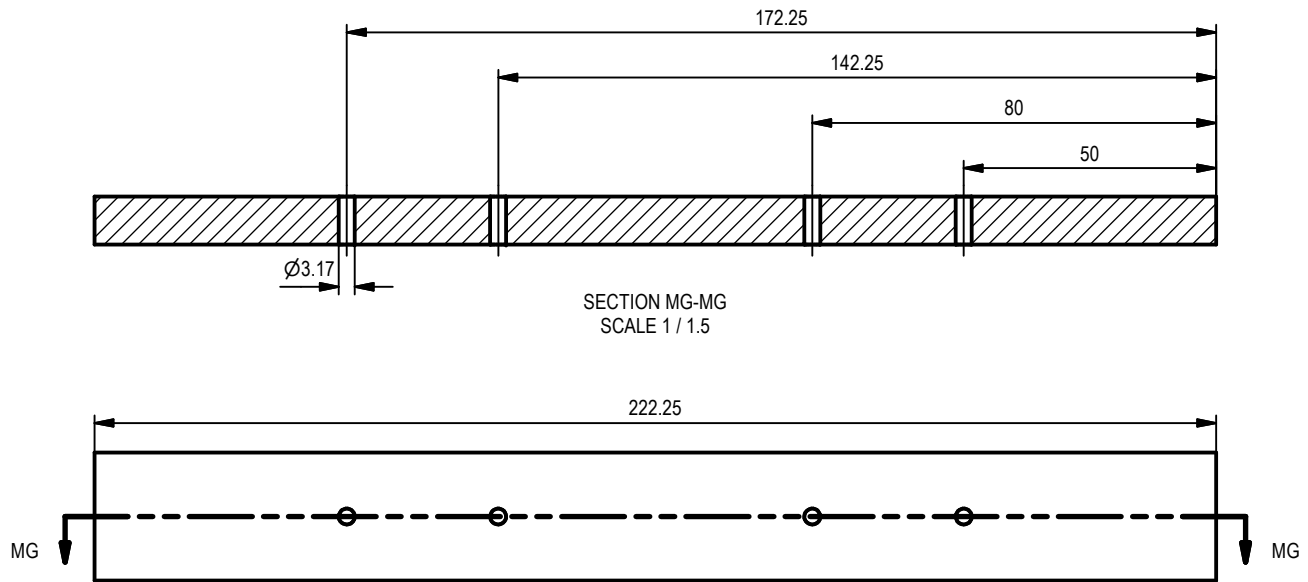
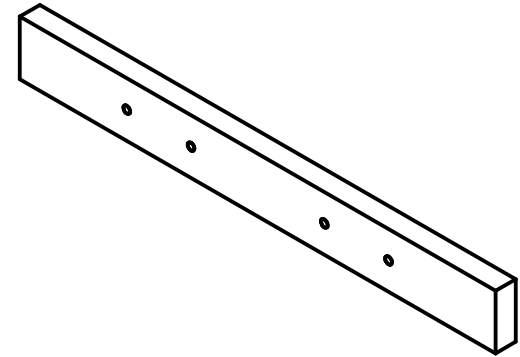

PROYECTO Marco de Colmena	CREADO POR A. PARDO	APROBADO POR			
NOMBRE DE PIEZA FRAME A	CÓDIGO 2.1	TIPO DE DOCUMENTO PART	MATERIAL WOOD		
	LICENCIA 	NOMBRE DE ARCHIVO FRAME A.ipt	VERSION 1.0	CANTIDAD 1	
		ESCALA 1 / 5	HOJA 13/16	FECHA 24-09-2020	



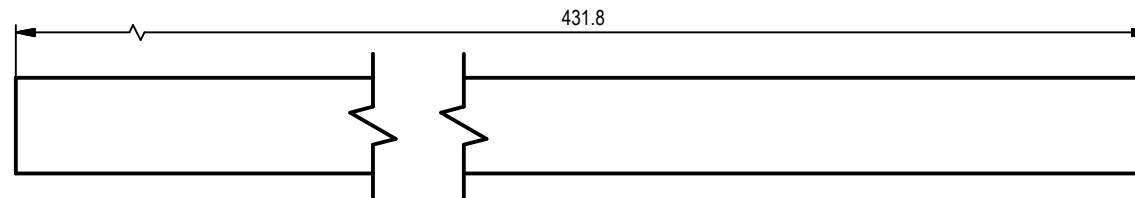
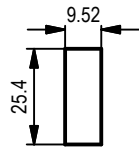
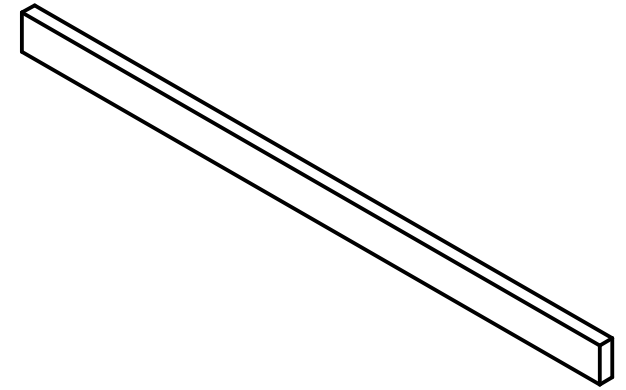

PROYECTO Marco de Colmena	CREADO POR A. PARDO	APROBADO POR		
NOMBRE DE PIEZA FRAME B	CÓDIGO 2.2	TIPO DE DOCUMENTO PART	MATERIAL WOOD	
	LICENCIA 	NOMBRE DE ARCHIVO FRAME B.ipt	VERSION 1.0	CANTIDAD 1
			ESCALA 1 / 1.5	FECHA 14/16 24-09-2020

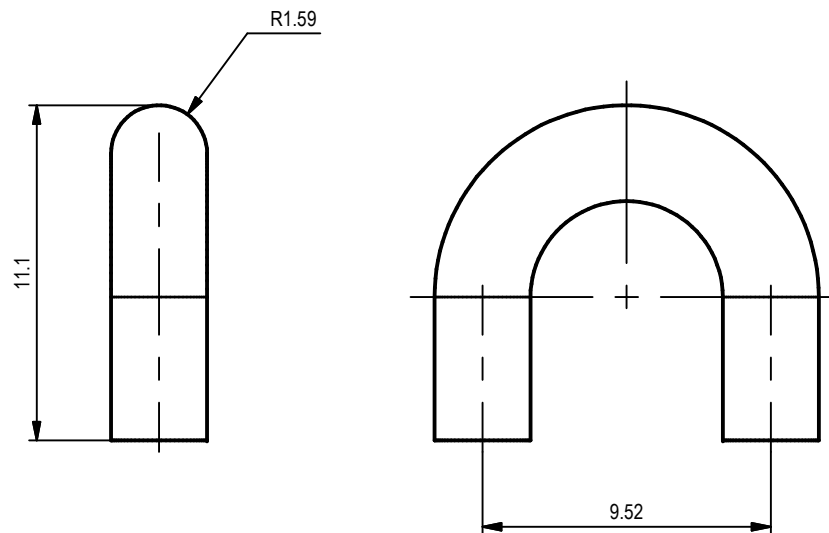
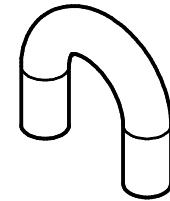

PROYECTO Marco de Colmena	CREADO POR A. PARDO	APROBADO POR			
NOMBRE DE PIEZA FRAME C	CÓDIGO 2.3	TIPO DE DOCUMENTO PART	MATERIAL WOOD		
 <small>OPEN SOURCE ECOLOGY GERMANY</small>	LICENCIA 	NOMBRE DE ARCHIVO FRAME C.ipt	VERSION 1.0	CANTIDAD 1	
		ESCALA 1 / 2	HOJA 15/16	FECHA 24-09-2020	



PROYECTO Marco de Colmena	CREADO POR A. PARDO	APROBADO POR			
NOMBRE DE PIEZA FRAME D	CÓDIGO 2.4	TIPO DE DOCUMENTO PART	MATERIAL STEEL METAL		
 <small>OPEN SOURCE ECOLOGY GERMANY</small>	LICENCIA 	NOMBRE DE ARCHIVO FRAME D.ipt	VERSION 1.0	CANTIDAD 1	
		ESCALA 4 : 1	HOJA 16/16	FECHA 01-10-2020	