

AL (1.2/1)

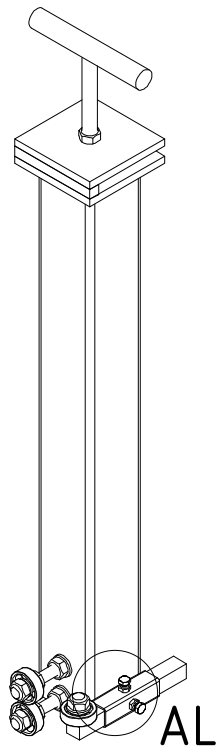

AL

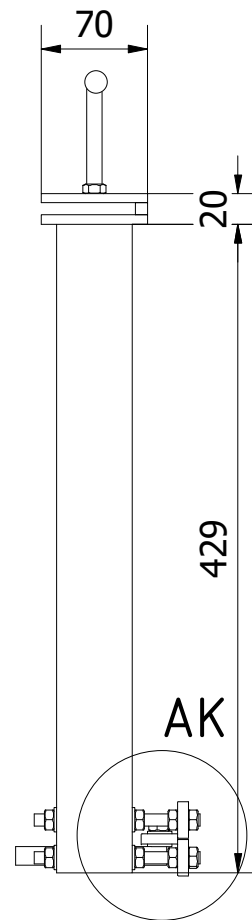

AK

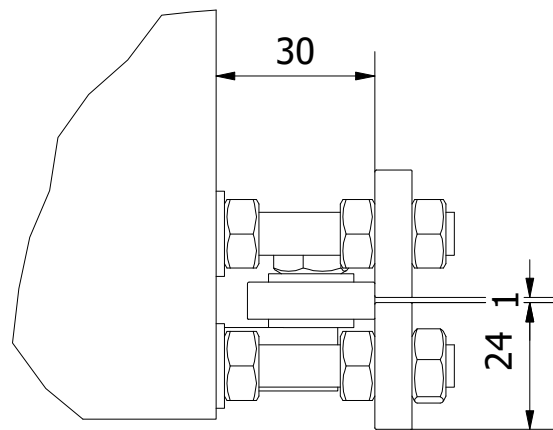
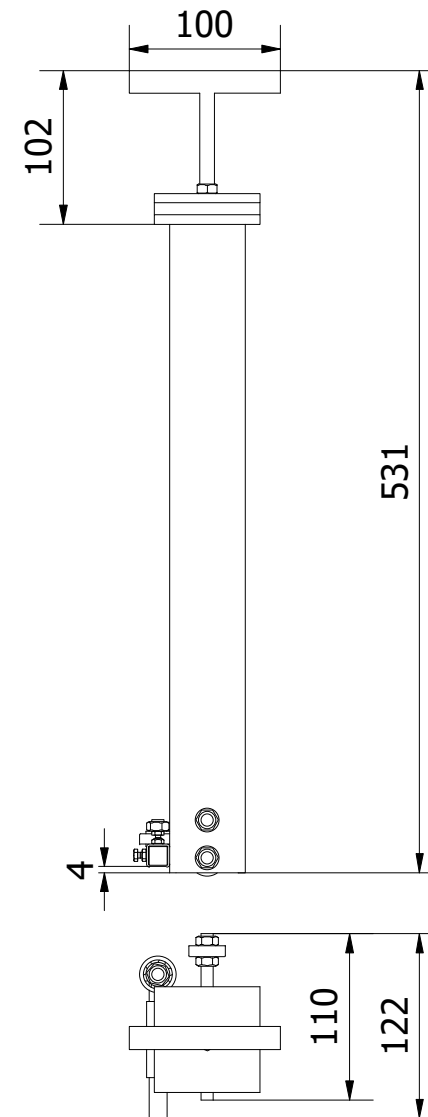

AK (0.7/1)

Note: All units in mm.

PROJECT	CREATED BY	APPROVED BY	DATE	VERSION
Bandsaw mill	J. Rosciano	A. Morillo	11/09/2021	1.1
PART NAME	FILE NAME			POS
Blade guide	Blade guide.iam			5.0
PUBLISHED BY	DOC. TYPE	MATERIAL	QUANTITY	
 OPEN HARDWARE OBSERVATORY Free Blueprints for Sustainable Development	Assembly		1	
	LICENCE	SCALE	SHEET	
OHO e.V.	CC-BY-SA 4.0	1/5	40 /71	

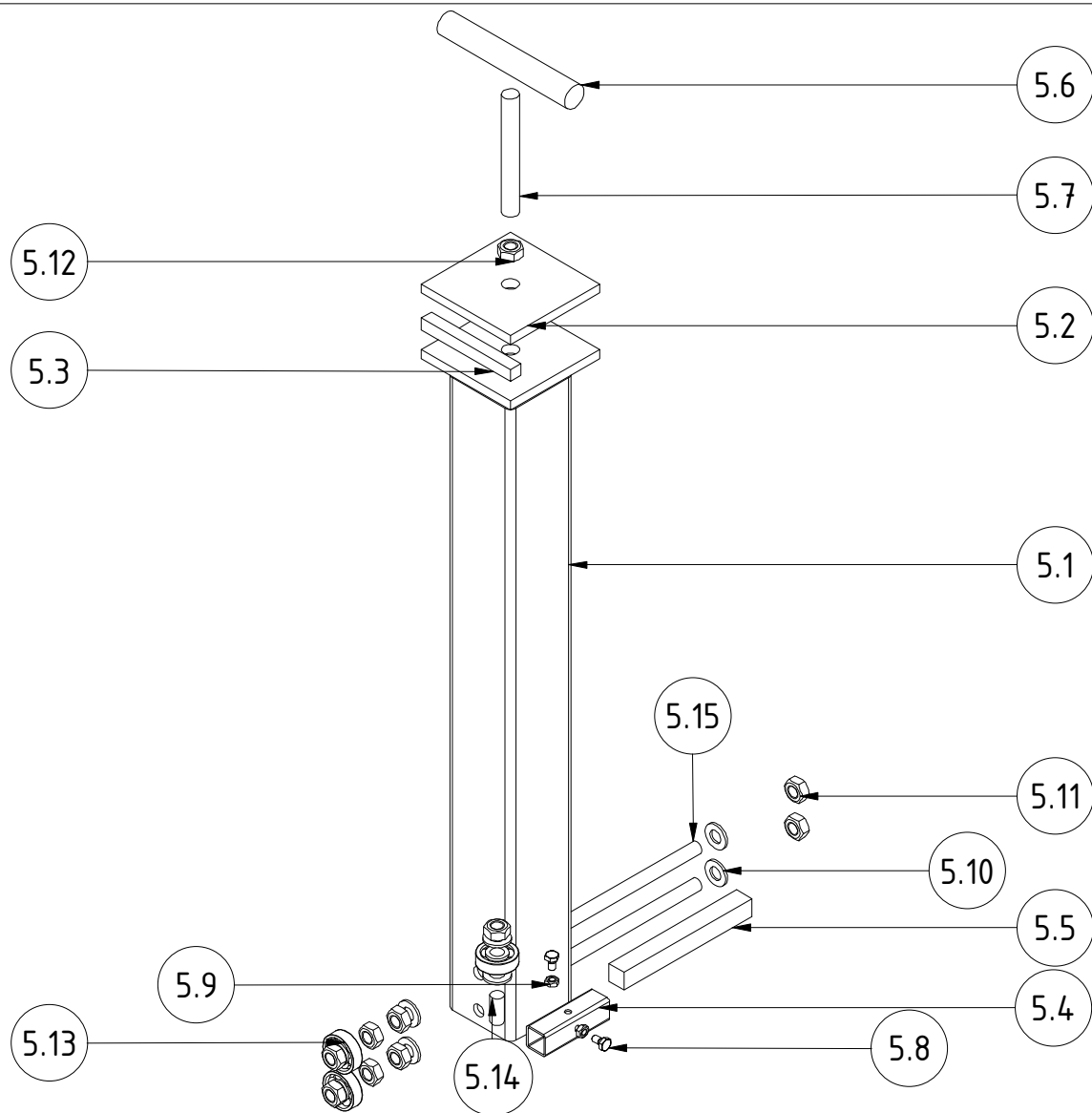

PROJECT	CREATED BY	APPROVED BY	DATE	VERSION
Bandsaw mill	J. Rosciano	A. Morillo	11/09/2021	1.1
PART NAME	FILE NAME			POS
Blade guide	Blade guide.ipn			5.0
PUBLISHED BY	DOC. TYPE	MATERIAL	QUANTITY	
 OPEN HARDWARE OBSERVATORY Free Blueprints for Sustainable Development	Assembly		1	
	LICENCE	SCALE	SHEET	
OHO e.V.	CC-BY-SA 4.0	1/4	41 /71	