

# ELEVATION ( 1 :20 )

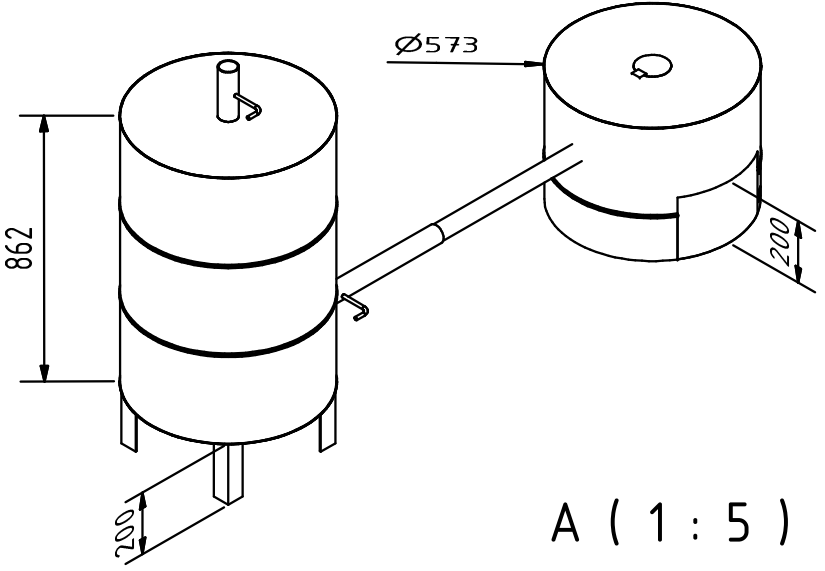

A ( 1 : 5 )

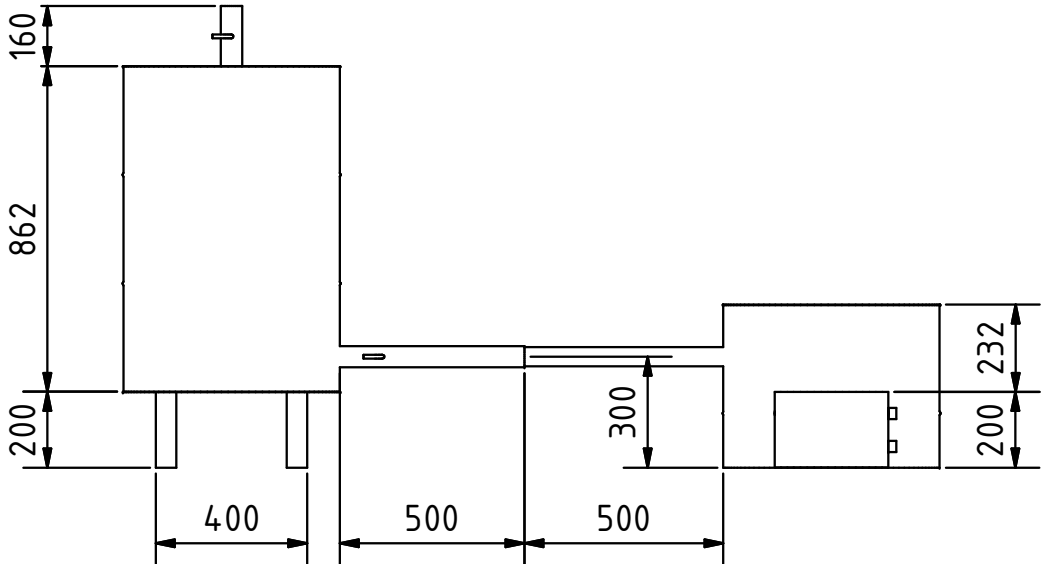

A-A ( 1 :20 )

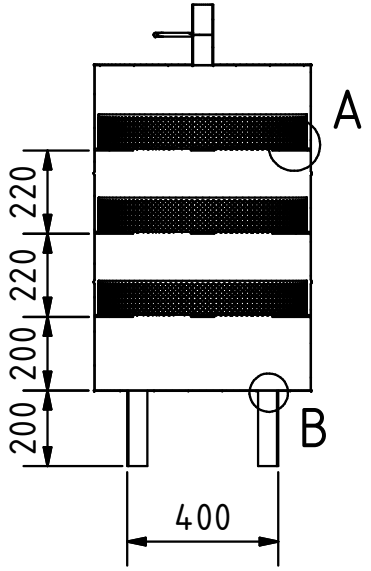

A ( 1 : 5 )

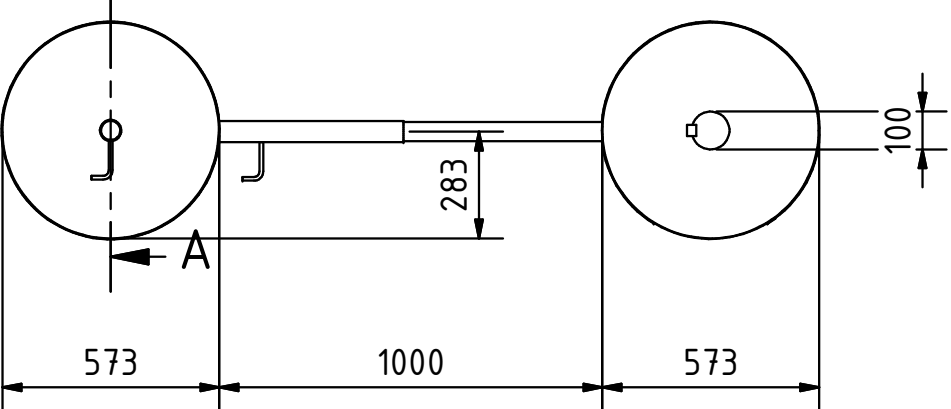
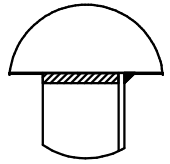

Note: all units are in mm

PROJECT	CREATED BY	APPROVED BY	DATE	VERSION
Drum Fish Dryer-Smoker	J. Zeron	A. Morillo	08-06-2021	1.0
PART NAME	FILE NAME			PART CODE
3d views	ilo_dfds_dum-fish-dryer-smoker.iam			A1
DEVELOPED BY	REDESIGNED BY	DOC. TYPE	MATERIAL	QUANTITY
		ASSEMBLY		1
INTERNATIONAL LABOUR OFFICE	OHO e.V.	LICENCE	SCALE	SHEET
		CC-BY-SA 4.0	1:20	1 /17

# EXPLOSION ( 1 : 15 )

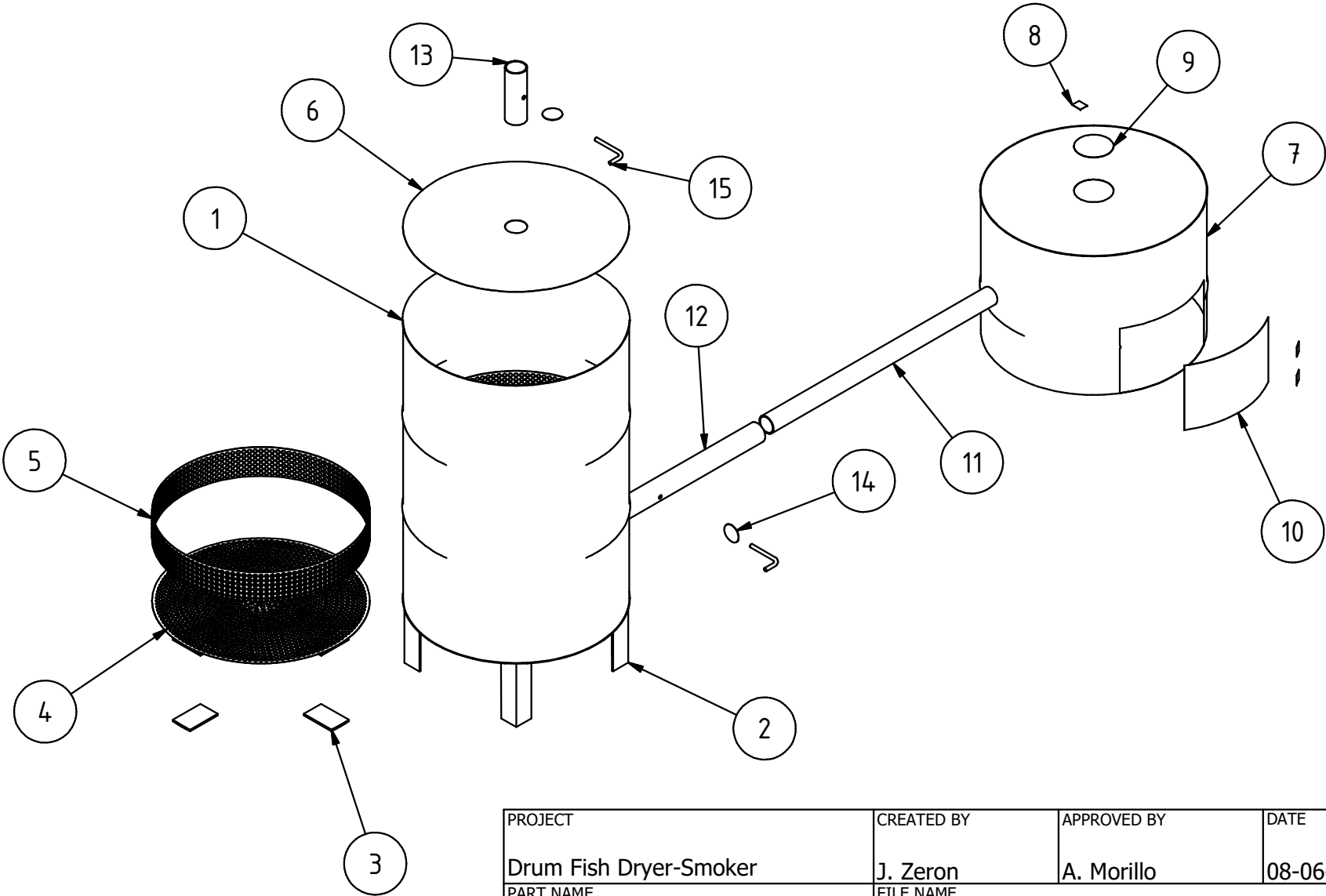

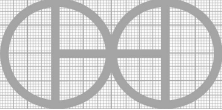
PROJECT		CREATED BY	APPROVED BY	DATE	VERSION
Drum Fish Dryer-Smoker		J. Zeron	A. Morillo	08-06-2021	1.0
PART NAME		FILE NAME			PART CODE
Exploded 3D View		ilo_dfds_dum-fish-dryer-smoker.ipn			A2
DEVELOPED BY		REDESIGNED BY		DOC. TYPE	MATERIAL
INTERNATIONAL LABOUR OFFICE		 OHO e.V.		ASSEMBLY	
		LICENCE		SCALE	QUANTITY
		CC-BY-SA 4.0		1:15	1
					SHEET
					2 / 17

**PART LIST**

POS	POS.OLD	QTY	PART NAME	FILE NAME	PART TYPE	SPECIFICATIONS	SHEET
A1	-	-	3D Views	manual-fuel-briquette-press.iam	ASSEMBLY	-	1
A2	-	-	Explode 3D View	ilo_dfds_dum-fish-dryer-smoker.ipn	ASSEMBLY	-	2
B1	-	-	Part List	ilo_dfds_dum-fish-dryer-smoker.csv	-	-	3
1	-	1	Smoker drum	Smoker drum.ipt	Production	Rolled steel	4
2	-	4	Foot	Foot.ipt	Production	Carbon steel angle 50x50x4 mm grade A42 L=20 cm	5
3	-	12	Tray base	Tray base.ipt	Production	Carbon steel platen 2" PS-25	6
4	-	3	Tray A	Tray A.ipt	Production	Perforded metal, thinckness 1-2 mm	7
5	-	3	Tray B	Tray B.ipt	Production	Perforded metal, thinckness 1-2 mm	8
6	-	1	Lid	Lid.ipt	Production	Metal drum scrap	9
7	-	1	Fire drum	Fire drum.ipt	Production	Metal drum scrap	10
8	-	3	Hinge	-	Buy	Brass 1", riveted	-
9	-	1	Upper nozzle	Upper nozzle.ipt	Production	Metal drum scrap	11
10	-	1	Side entrance	Side entrance.ipt	Production	Metal drum scrap	12
11	-	1	Tube A	Tube A.ipt	Production	2" Black iron L=80cm	13
12	-	1	Tube B	Tube B.ipt	Production	2 1/4" Black iron L=50cm	14
13	-	1	Tube C	Tube C.ipt	Production	2 1/4" Black iron L=16cm	15
14	-	2	Nozzle	Nozzle.ipt	Production	Sheet metal	16
15	-	2	Bar	Bar.ipt	Production	Flat bar 3/8"	17

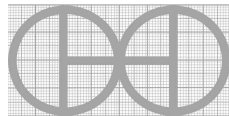
PROJECT		CREATED BY	APPROVED BY	DATE	VERSION
Drum Fish Dryer-Smoker		J. Zeron	A. Morillo	08-06-2021	1.0
PART NAME		FILE NAME			PART CODE
PART LIST		ilo_dfds_dum-fish-dryer-smoker.csv			B1
DEVELOPED BY		REDESIGNED BY		DOC. TYPE	MATERIAL
				PART LIST	
INTERNATIONAL LABOUR OFFICE				LICENCE	SCALE
		OHO e.V.		CC-BY-SA 4.0	3 / 17

# ELEVATION ( 1 : 15 )

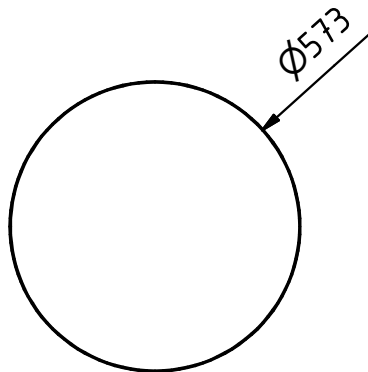
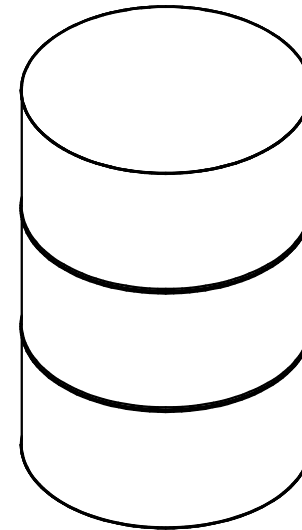
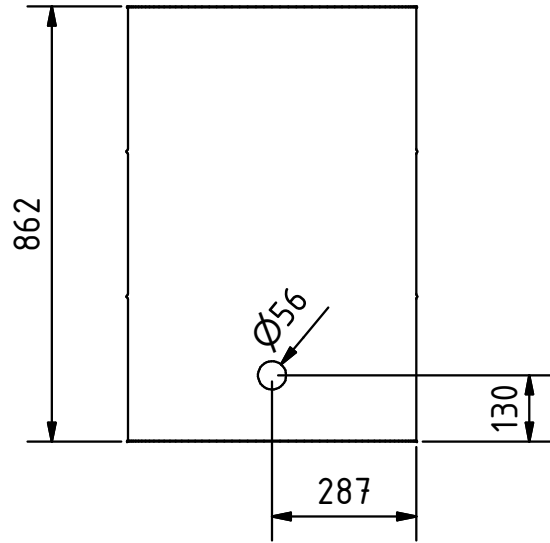

Note: all units are in mm

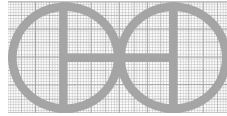
PROJECT	CREATED BY	APPROVED BY	DATE	VERSION
Drum Fish Dryer-Smoker	J. Zeron	A. Morillo	08-06-2021	1.0
PART NAME	FILE NAME			PART CODE
Smoker Drum	Smoker Drum.ipt			1
DEVELOPED BY	REDESIGNED BY	DOC. TYPE	MATERIAL	QUANTITY
		PART	Rolled steel	1
INTERNATIONAL LABOUR OFFICE	OHO e.V.	LICENCE	SCALE	SHEET
		CC-BY-SA 4.0	1:13	4 / 17

# ELEVATION ( 1 : 3 )

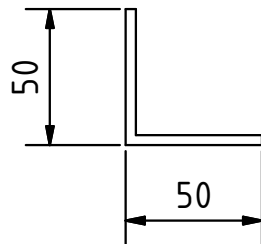
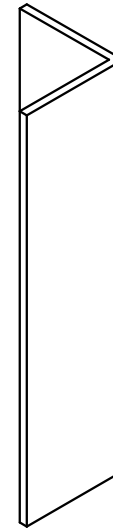
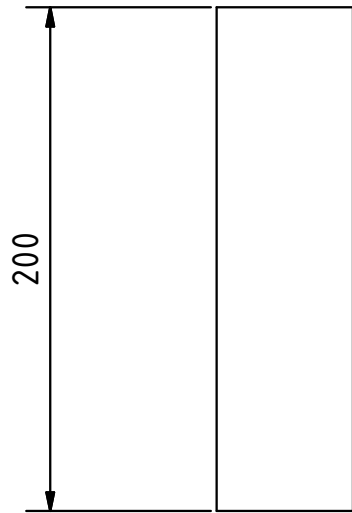

Note: all units are in mm

PROJECT		CREATED BY	APPROVED BY	DATE	VERSION
Drum Fish Dryer-Smoker		J. Zeron	A. Morillo	08-06-2021	1.0
PART NAME		FILE NAME			PART CODE
Foot		Foot.ipt			2
DEVELOPED BY		REDESIGNED BY		DOC. TYPE	MATERIAL
INTERNATIONAL LABOUR OFFICE				PART	Carbon Steel
				LICENCE	SCALE
		OHO e.V.		CC-BY-SA 4.0	1:3
					4
					5 / 17

# PLAN ( 1 : 2 )

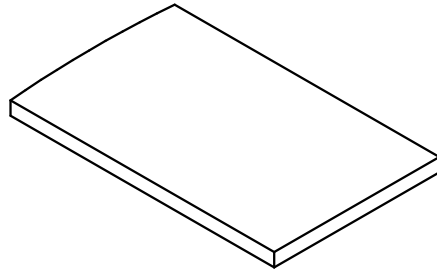
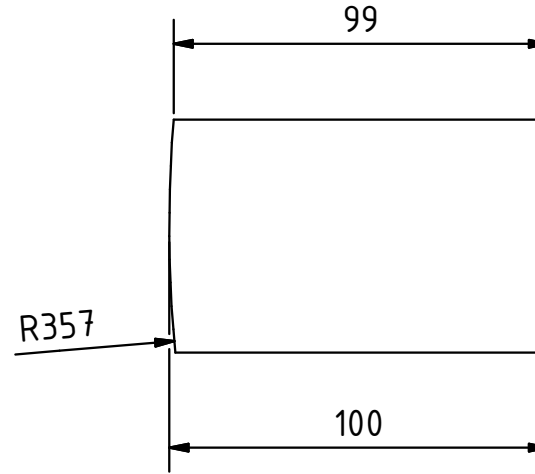
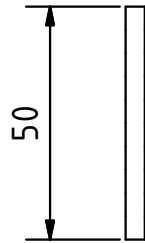

Note: all units are in mm

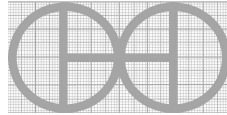
PROJECT	CREATED BY	APPROVED BY	DATE	VERSION
Drum Fish Dryer-Smoker	J. Zeron	A. Morillo	08-06-2021	1.0
PART NAME	FILE NAME			PART CODE
Tray Base	Tray Base.ipt			3
DEVELOPED BY	REDESIGNED BY	DOC. TYPE	MATERIAL	QUANTITY
		PART	Carbon Steel	12
INTERNATIONAL LABOUR OFFICE	OHO e.V.	LICENCE	SCALE	SHEET
		CC-BY-SA 4.0	1:2	6 / 17

PLAN ( 1 : 8 )

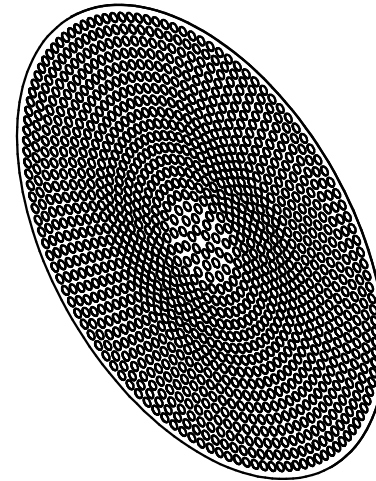
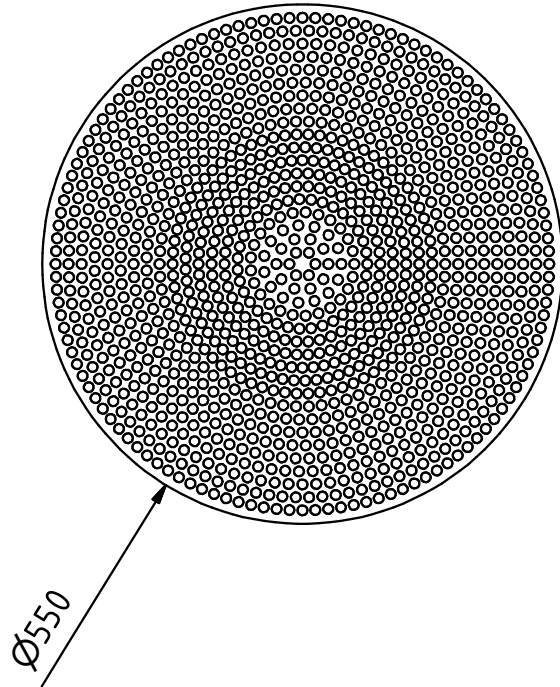

Note: all units are in mm

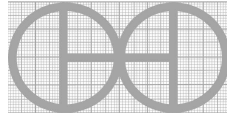
PROJECT		CREATED BY	APPROVED BY	DATE	VERSION
Drum Fish Dryer-Smoker		J. Zeron	A. Morillo	08-06-2021	1.0
PART NAME		FILE NAME			PART CODE
Tray A		Tray A.ipt			4
DEVELOPED BY		REDESIGNED BY		DOC. TYPE	MATERIAL
INTERNATIONAL LABOUR OFFICE		 OHO e.V.		PART	Perford metal
				LICENCE	SCALE
		CC-BY-SA 4.0		1:8	7 / 17

PLAN ( 1 : 8 )

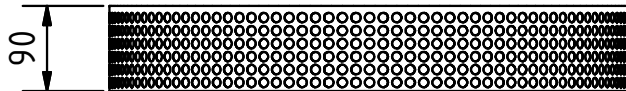
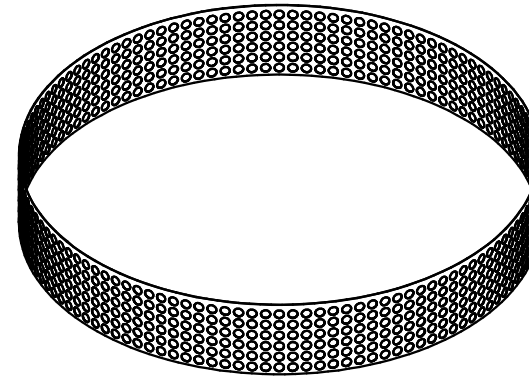
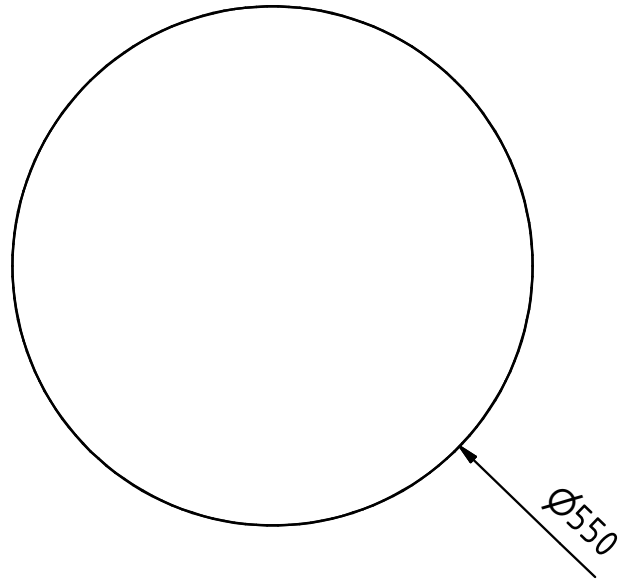

Note: all units are in mm

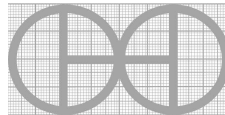
PROJECT		CREATED BY	APPROVED BY	DATE	VERSION
Drum Fish Dryer-Smoker		J. Zeron	A. Morillo	08-06-2021	1.0
PART NAME		FILE NAME			PART CODE
Tray B		Tray B.ipt			5
DEVELOPED BY		REDESIGNED BY		DOC. TYPE	MATERIAL
INTERNATIONAL LABOUR OFFICE		 OHO e.V.		PART	Perforated metal
				LICENCE	SCALE
		CC-BY-SA 4.0		1:8	3
					8 / 17



PLAN ( 1 : 8 )

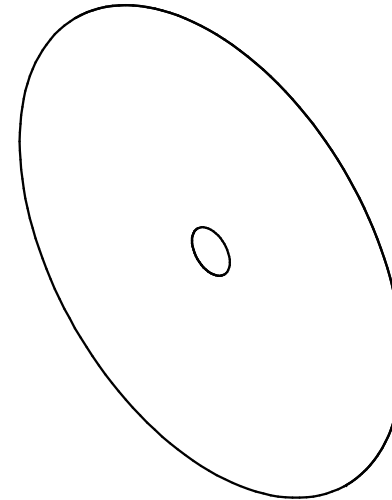
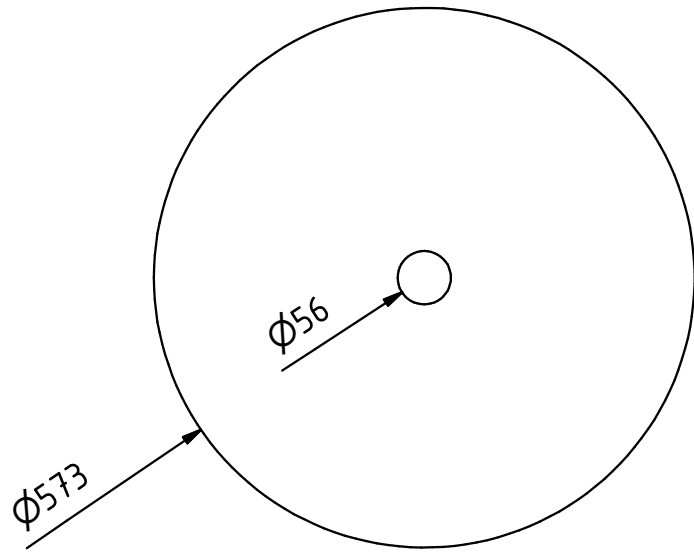

Note: all units are in mm

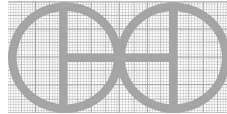
PROJECT	CREATED BY	APPROVED BY	DATE	VERSION
Drum Fish Dryer-Smoker	J. Zeron	A. Morillo	08-06-2021	1.0
PART NAME	FILE NAME			PART CODE
Lid	Lid.ipt			6
DEVELOPED BY	REDESIGNED BY	DOC. TYPE	MATERIAL	QUANTITY
		PART	Metal Drum Scrap	1
INTERNATIONAL LABOUR OFFICE	OHO e.V.	LICENCE	SCALE	SHEET
		CC-BY-SA 4.0	1:8	9 / 17

# ELEVATION ( 1 : 10 )

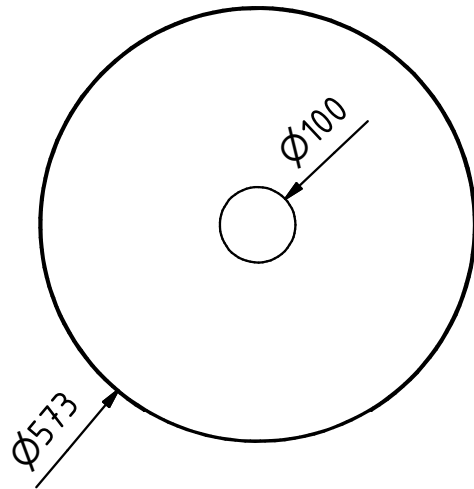
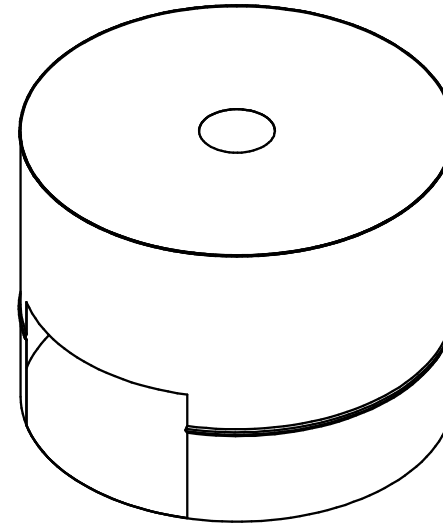
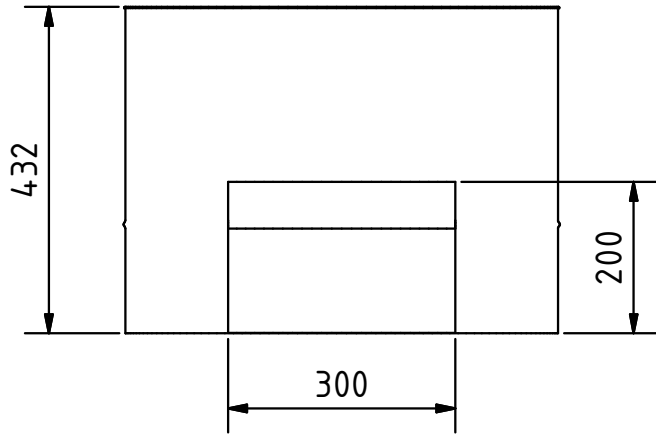

Note: all units are in mm

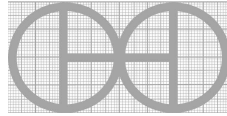
PROJECT	CREATED BY	APPROVED BY	DATE	VERSION
Drum Fish Dryer-Smoker	J. Zeron	A. Morillo	08-06-2021	1.0
PART NAME	FILE NAME			PART CODE
Fire Drum	Fire Drum.ipt			7
DEVELOPED BY	REDESIGNED BY	DOC. TYPE	MATERIAL	QUANTITY
		PART	Metal Drum Scrap	1
INTERNATIONAL LABOUR OFFICE	OHO e.V.	LICENCE	SCALE	SHEET
		CC-BY-SA 4.0	1:10	10 / 17

PLAN ( 1 : 2 )

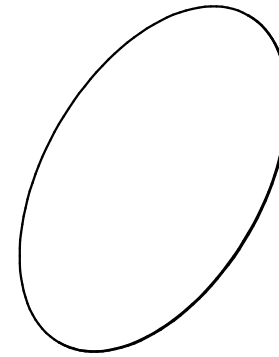
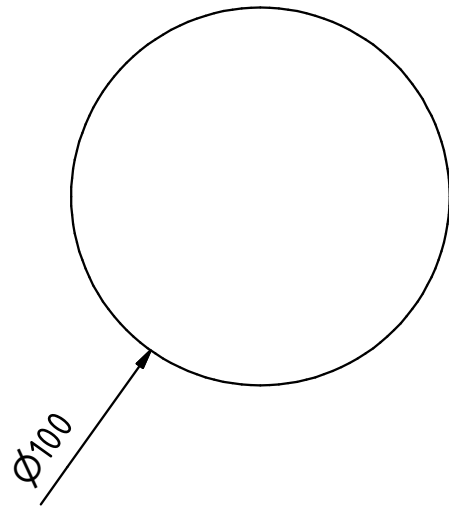

Note: all units are in mm

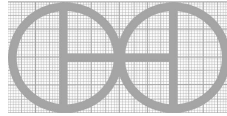
PROJECT		CREATED BY	APPROVED BY	DATE	VERSION
Drum Fish Dryer-Smoker		J. Zeron	A. Morillo	08-06-2021	1.0
PART NAME		FILE NAME			PART CODE
Upper Nozzle		Upper Nozzle.ipt			9
DEVELOPED BY		REDESIGNED BY	DOC. TYPE	MATERIAL	QUANTITY
INTERNATIONAL LABOUR OFFICE		 OHO e.V.	PART	Metal Drum Scrap	1
			LICENCE	SCALE	SHEET
		CC-BY-SA 4.0	1:2	11 /17	

# ELEVATION ( 1 : 5 )

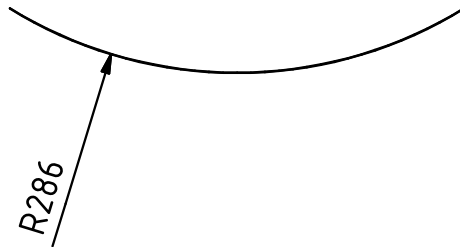
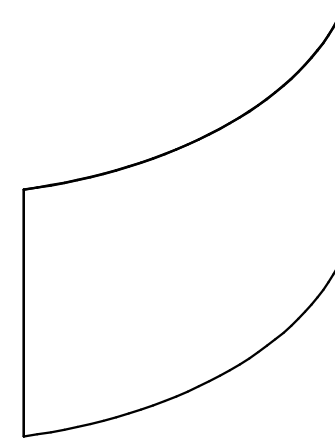
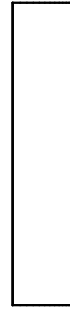
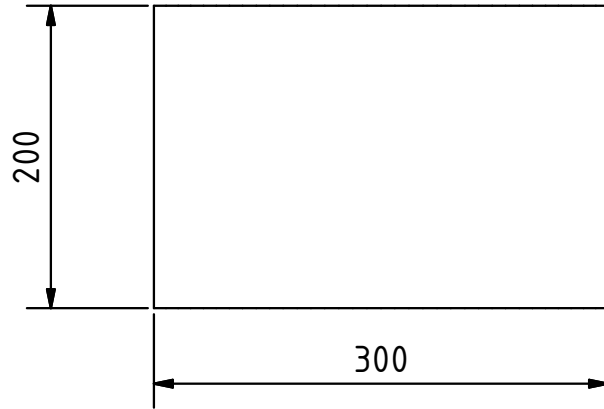

Note: all units are in mm

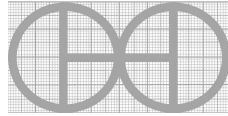
PROJECT	CREATED BY	APPROVED BY	DATE	VERSION
Drum Fish Dryer-Smoker	J. Zeron	A. Morillo	08-06-2021	1.0
PART NAME	FILE NAME			PART CODE
Side Entrance	Side Entrance.ipt			10
DEVELOPED BY	REDESIGNED BY	DOC. TYPE	MATERIAL	QUANTITY
		PART	Metal Drum Scrap	1
INTERNATIONAL LABOUR OFFICE	OHO e.V.	LICENCE	SCALE	SHEET
		CC-BY-SA 4.0	1:5	12 /17

# ELEVATION ( 1 : 5 )

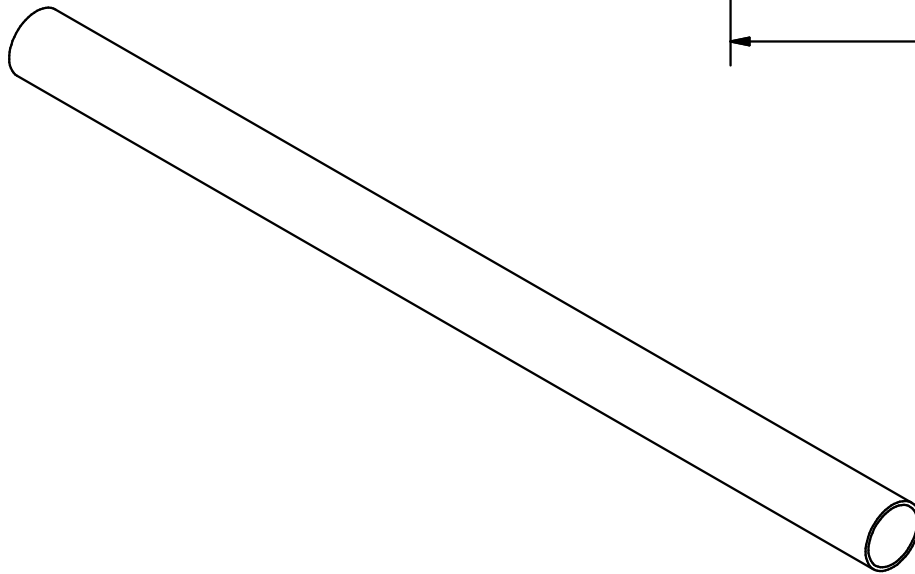
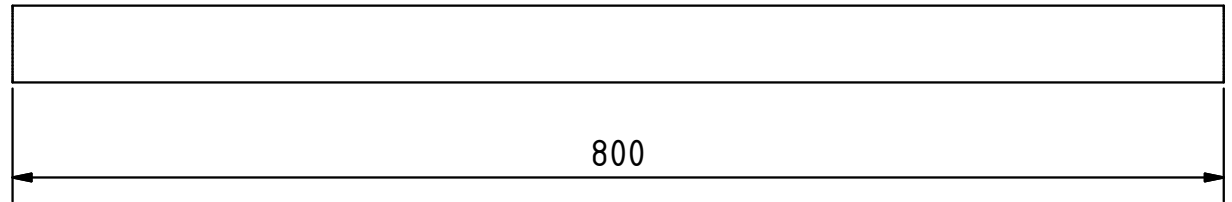
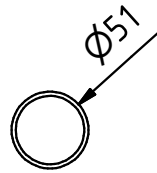

Note: all units are in mm

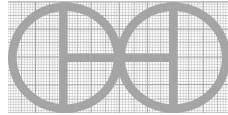
PROJECT	CREATED BY	APPROVED BY	DATE	VERSION
Drum Fish Dryer-Smoker	J. Zeron	A. Morillo	08-06-2021	1.0
PART NAME	FILE NAME			PART CODE
Tube A	Tube A.ipt			11
DEVELOPED BY	REDESIGNED BY	DOC. TYPE	MATERIAL	QUANTITY
		PART	Black Iron	1
INTERNATIONAL LABOUR OFFICE	OHO e.V.	LICENCE	SCALE	SHEET
		CC-BY-SA 4.0	1:5	13 / 17

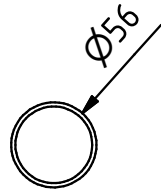

ELEVATION ( 1 : 5 )

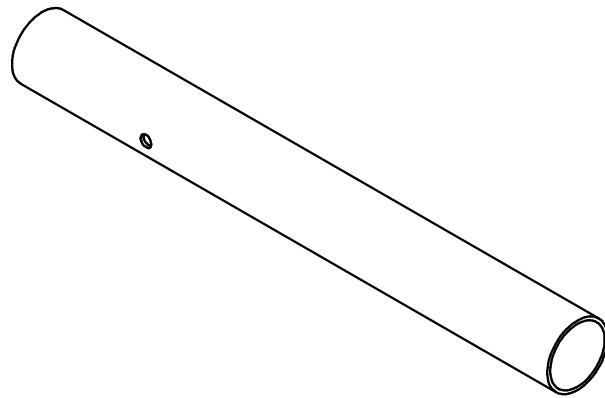
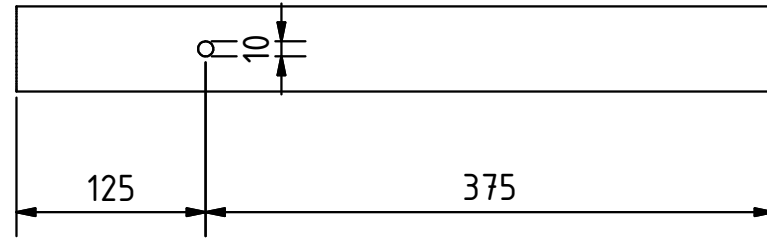

Note: all units are in mm

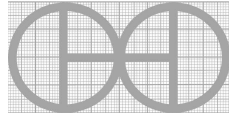
PROJECT	CREATED BY	APPROVED BY	DATE	VERSION
Drum Fish Dryer-Smoker	J. Zeron	A. Morillo	08-06-2021	1.0
PART NAME	FILE NAME			PART CODE
Tube B	Tube B.ipt			12
DEVELOPED BY	REDESIGNED BY	DOC. TYPE	MATERIAL	QUANTITY
		PART	Black Iron	1
INTERNATIONAL LABOUR OFFICE	OHO e.V.	LICENCE	SCALE	SHEET
		CC-BY-SA 4.0	1:5	14 /17

# ELEVATION ( 1 : 3 )

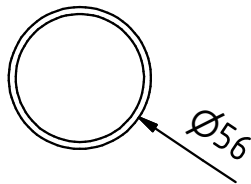
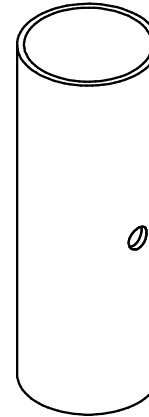
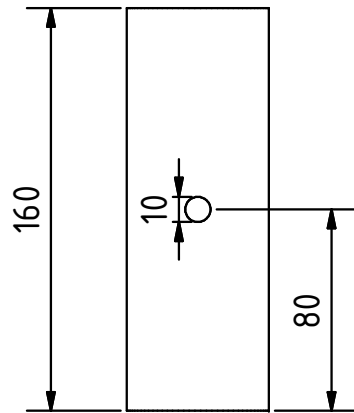

Note: all units are in mm

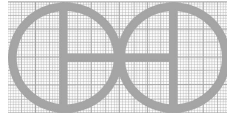
PROJECT	CREATED BY	APPROVED BY	DATE	VERSION
Drum Fish Dryer-Smoker	J. Zeron	A. Morillo	08-06-2021	1.0
PART NAME	FILE NAME			PART CODE
Exhaust Tube	Exhaust Tube.ipt			13
DEVELOPED BY	REDESIGNED BY	DOC. TYPE	MATERIAL	QUANTITY
		PART	Black Iron	1
INTERNATIONAL LABOUR OFFICE	OHO e.V.	LICENCE	SCALE	SHEET
		CC-BY-SA 4.0	1:3	15 /17

PLAN ( 1 : 1 )

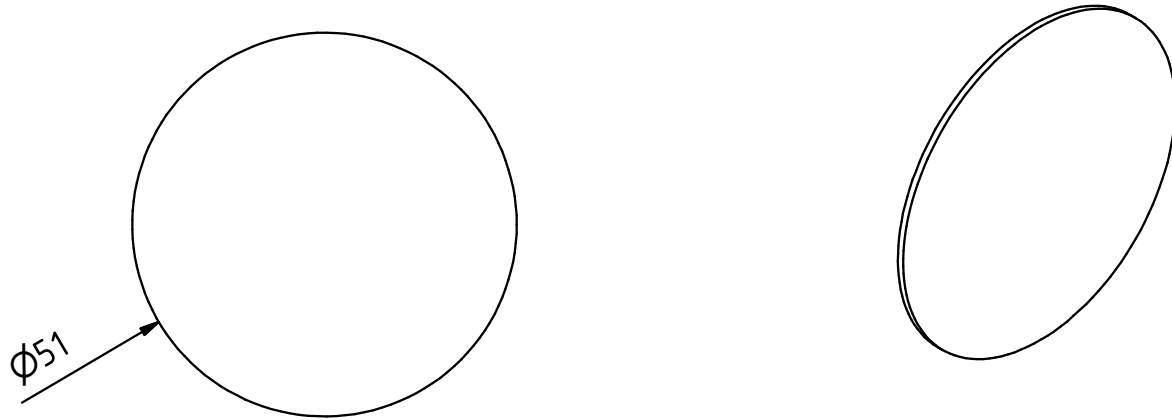

Note: all units are in mm

PROJECT		CREATED BY	APPROVED BY	DATE	VERSION
Drum Fish Dryer-Smoker		J. Zeron	A. Morillo	08-06-2021	1.0
PART NAME		FILE NAME			PART CODE
Nozzle		Nozzle.ipt			14
DEVELOPED BY		REDESIGNED BY		DOC. TYPE	MATERIAL
INTERNATIONAL LABOUR OFFICE				PART	Sheet metal
				LICENCE	SCALE
		OHO e.V.		CC-BY-SA 4.0	1:1
					16 / 17



# PLAN ( 1 : 2 )

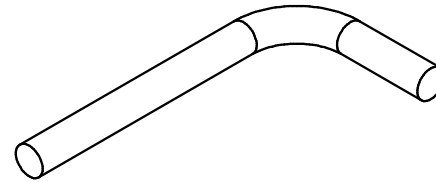
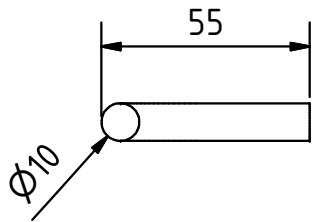
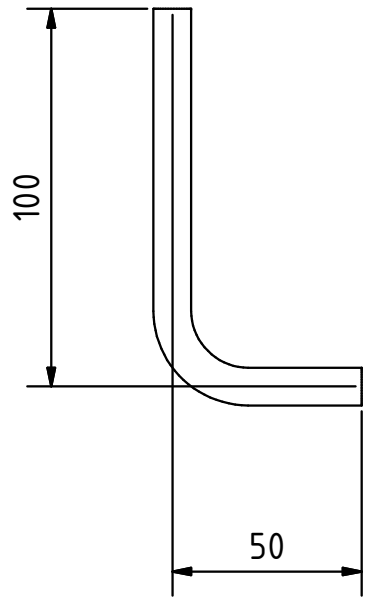

Note: all units are in mm

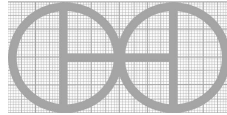
PROJECT	CREATED BY	APPROVED BY	DATE	VERSION
Drum Fish Dryer-Smoker	J. Zeron	A. Morillo	08-06-2021	1.0
PART NAME	FILE NAME			PART CODE
Bar	Bar.ipt			15
DEVELOPED BY	REDESIGNED BY	DOC. TYPE	MATERIAL	QUANTITY
		PART	Flat bar	2
INTERNATIONAL LABOUR OFFICE	OHO e.V.	LICENCE	SCALE	SHEET
		CC-BY-SA 4.0	1:2	17 / 17