







PROYECTO Cajón de abejas	CREADO POR A. PARDO	APROBADO POR		
NOMBRE DE PIEZA BEE HIVE	CÓDIGO 1	TIPO DE DOCUMENTO ASSEMBY	MATERIAL WOOD	
 OPEN SOURCE ECOLOGY GERMANY	LICENCIA 	NOMBRE DE ARCHIVO BEE HIVE.iam	VERSION 1.0	CANTIDAD 1
		ESCALA 1 / 19	HOJA 1/30	FECHA 25-09-2020

PARTS LIST						
POS.	POS. OLD	CANT	NOMBRE DE PIEZA	NOMBRE DE ARCHIVO	TIPO PZA	ESPECIFICACIONES
1		1	BEE HIVE	BEE HIVE	ASSEMBLY	
1.1		1	PARTS LIST	BROOD CHAMBER.iam	ASSEMBLY	
1.2		1	BROOD CHAMBER	BROOD CHAMBER.iam	ASSEMBLY	
1.3		1	BROOD CHAMBER A	BROOD CHAMBER A.ipt	PART	
1.4		2	BROOD CHAMBER B	BROOD CHAMBER B.ipt	PART	
2		1	REVERSIBLE BOTTOM BOARD	REVERSIBLE BOTTOM BOARD.iam	ASSEMBLY	
2.1		1	REVERSIBLE BOTTOM BOARD A	REVERSIBLE BOTTOM BOARD A.ipt	PART	
2.2		1	REVERSIBLE BOTTOM BOARD B	REVERSIBLE BOTTOM BOARD B.ipt	PART	
2.3		1	REVERSIBLE BOTTOM BOARD C	REVERSIBLE BOTTOM BOARD C.ipt	PART	
2.4		1	REVERSIBLE BOTTOM BOARD D	REVERSIBLE BOTTOM BOARD D.ipt	PART	
2.5		1	REVERSIBLE BOTTOM BOARD E	REVERSIBLE BOTTOM BOARD E.ipt	PART	
3		1	OUTER COVER	OUTER COVER.iam	ASSEMBLY	
3.1		1	OUTER COVER A	OUTER COVER A.ipt	PART	
3.2		2	OUTER COVER B	OUTER COVER B.ipt	PART	
3.3		2	OUTER COVER C	OUTER COVER C.ipt	PART	
4		1	INNER COVER	INNER COVER.iam	ASSEMBLY	
4.1		2	INNER COVER A	INNER COVER A.ipt	PART	
4.2		2	INNER COVER B	INNER COVER B.ipt	PART	
4.3		1	INNER COVER C	INNER COVER C.ipt	PART	
5		1	SHALLOW SUPER	SHALLOW SUPER.iam	ASSEMBLY	
5.1		2	SHALLOW SUPER A	SHALLOW SUPER A.ipt	PART	
5.2		2	SHALLOW SUPER B	SHALLOW SUPER B.ipt	PART	
6		1	BROOD FRAME	BROOD FRAME.iam	ASSEMBLY	
6.1		1	BROOD FRAME A	BROOD FRAME A.ipt	PART	
6.2		2	BROOD FRAME B	BROOD FRAME B.ipt	PART	
6.3		1	BROOD FRAME C	BROOD FRAME C.ipt	PART	
7		1	SHALLOW SUPER FRAME	SHALLOW SUPER FRAME.iam	ASSEMBLY	
6.1		1	BROOD FRAME A	BROOD FRAME A	PART	
6.2		1	BROOD FRAME B	BROOD FRAME B	PART	
7.1		2	SHALLOW SUPER FRAME A	SHALLOW SUPER FRAME A.ipt	PART	

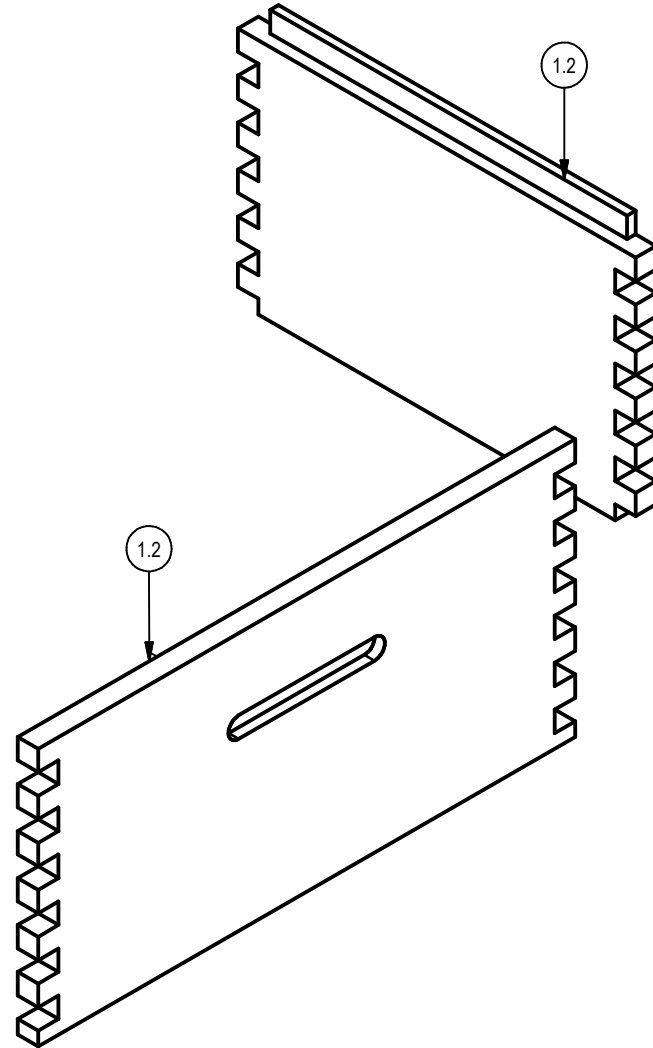
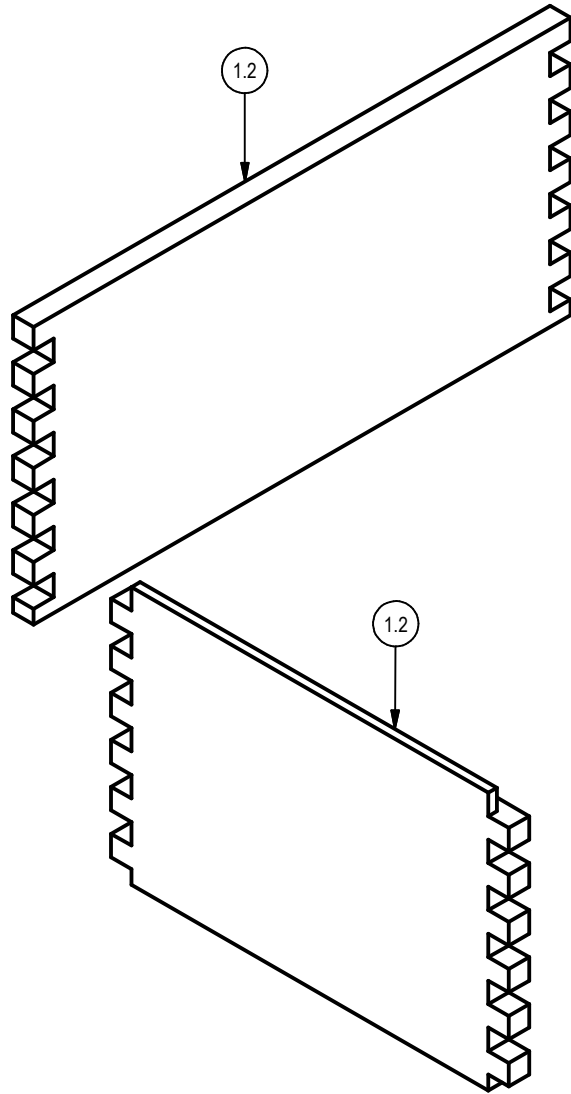

PROYECTO Cajón de abejas	CREADO POR A. PARDO	APROBADO POR			
NOMBRE DE PIEZA BEE HIVE	CÓDIGO 1.1	TIPO DE DOCUMENTO ASSEMBY	MATERIAL WOOD		
	LICENCIA 	NOMBRE DE ARCHIVO PART LIST BEE HIVE.iam	VERSION 1.0	CANTIDAD 1	
		ESCALA 1 / 20	HOJA 2/28	FECHA 01-10-2020	



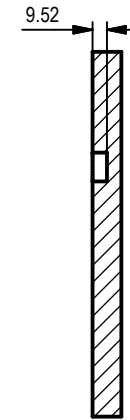
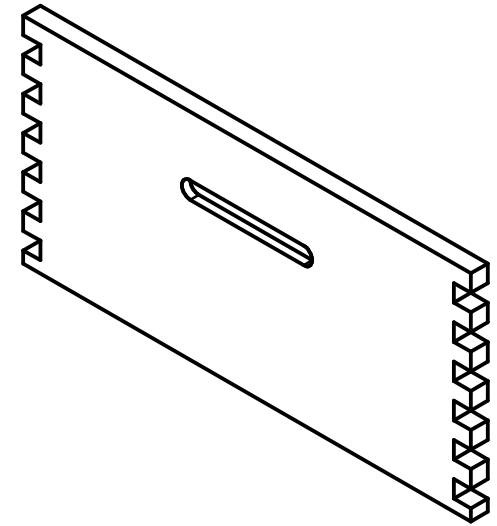
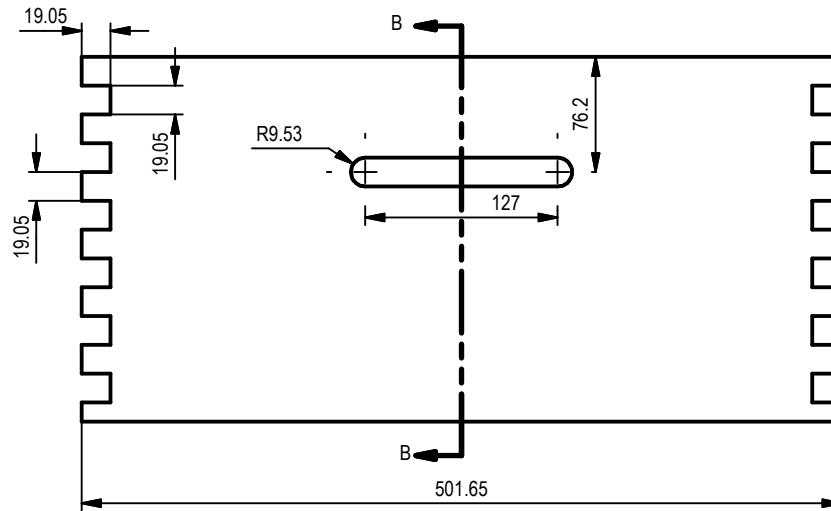
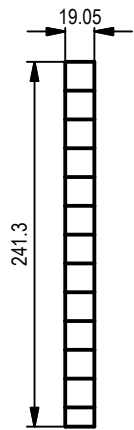

PROYECTO Cajón de abejas	CREADO POR A. PARDO	APROBADO POR		
NOMBRE DE PIEZA BROOD CHAMBER	CÓDIGO 1.2	TIPO DE DOCUMENTO ASSEMBY	MATERIAL WOOD	
	LICENCIA 	NOMBRE DE ARCHIVO BROOD CHAMBER.iam	VERSION 1.0	CANTIDAD 1
		ESCALA 1:5	HOJA 3/28	FECHA 25-09-2020



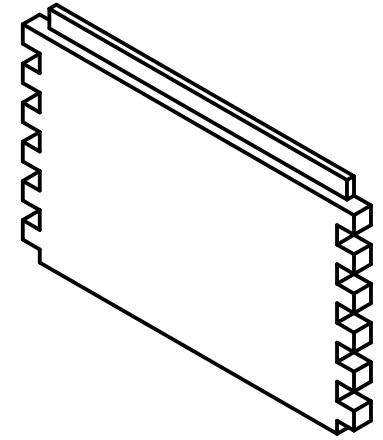
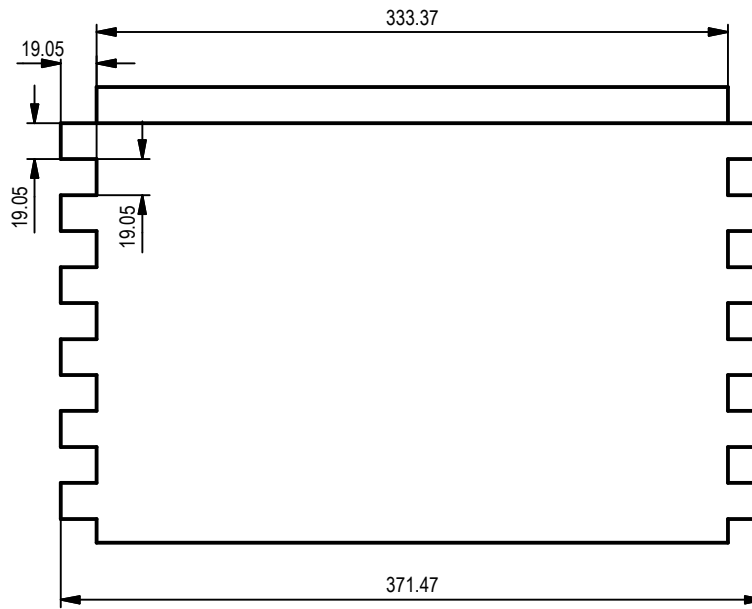
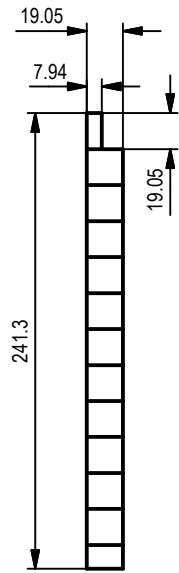

SECTION B-B
SCALE 1 / 5

PROYECTO Cajón de abejas	CREADO POR A. PARDO	APROBADO POR		
NOMBRE DE PIEZA BROOD CHAMBER A	CÓDIGO 1.3	TIPO DE DOCUMENTO ASSEMBY	MATERIAL WOOD	
 <p>OPEN SOURCE ECOLOGY GERMANY</p>	LICENCIA 	NOMBRE DE ARCHIVO BROOD CHAMBER A.ipt	VERSION 1.0	CANTIDAD 1
		ESCALA 1 / 5	HOJA 4/28	FECHA 25-09-2020



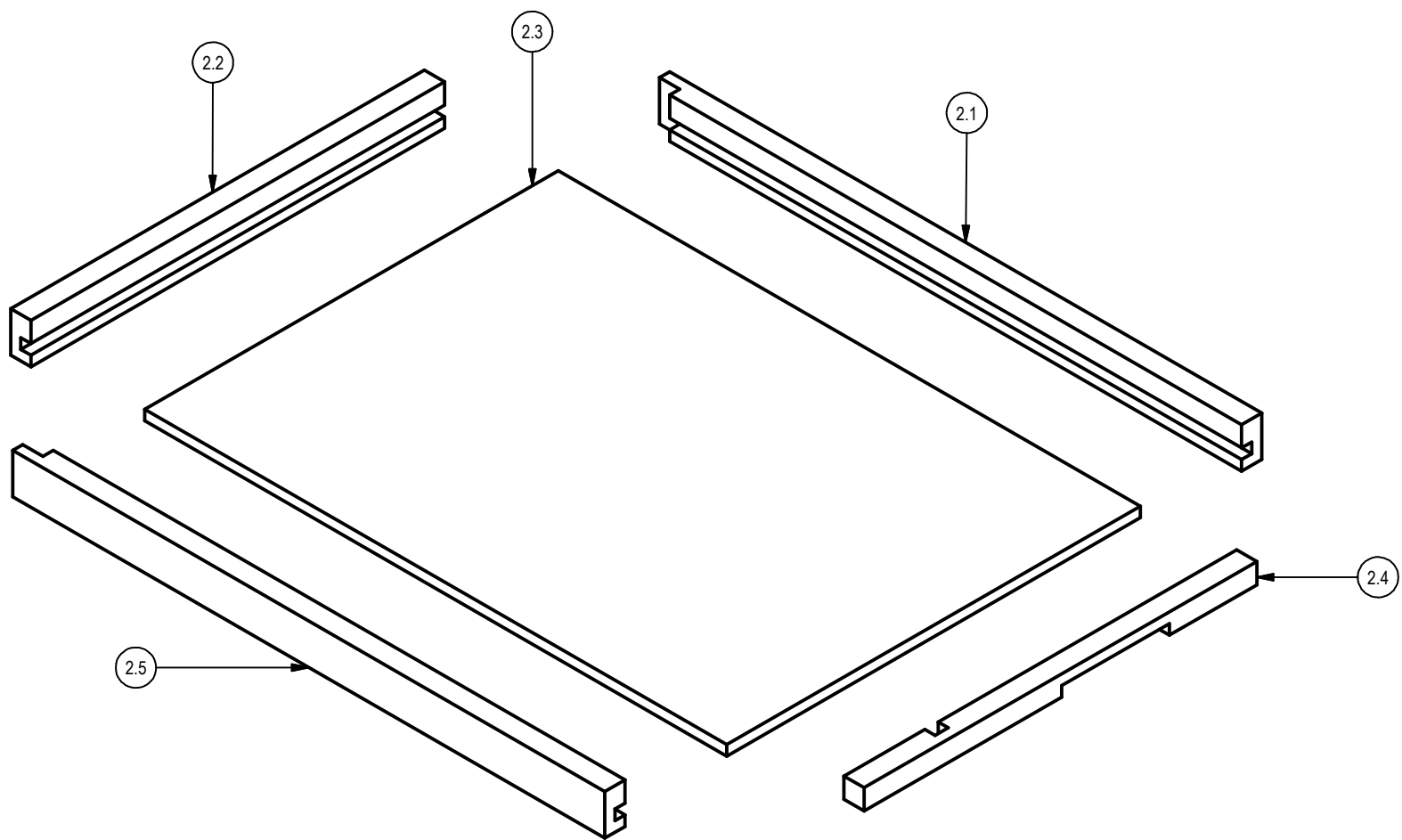

PROYECTO Cajón de abejas	CREADO POR A. PARDO	APROBADO POR		
NOMBRE DE PIEZA BROOD CHAMBER B	CÓDIGO 1.4	TIPO DE DOCUMENTO ASSEMBY	MATERIAL WOOD	
 <small>OPEN SOURCE ECOLOGY GERMANY</small>	LICENCIA 	NOMBRE DE ARCHIVO BROOD CHAMBER B.ipt	VERSION 1.0	CANTIDAD 1
		ESCALA 1 / 4	HOJA 5/30	FECHA 25-09-2020



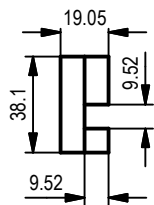
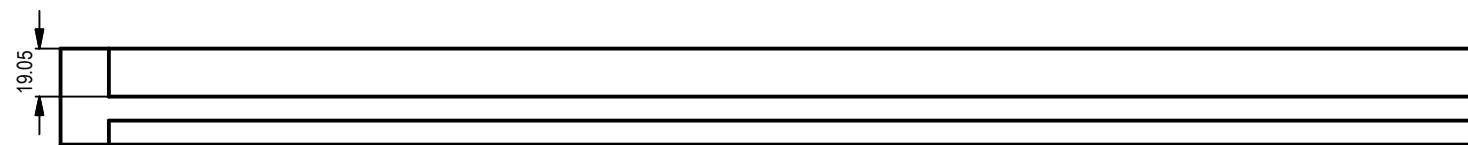
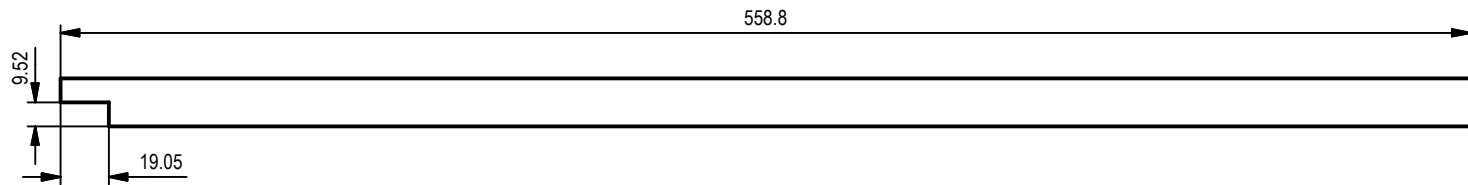
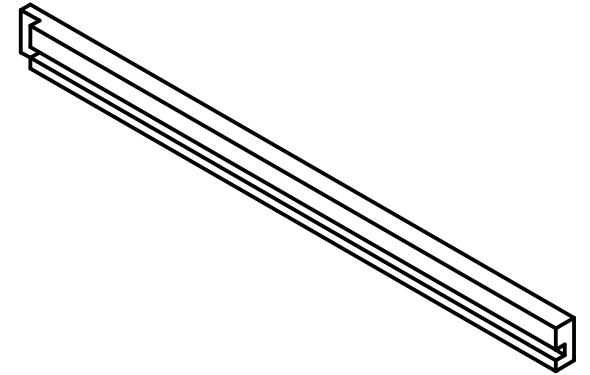

PROYECTO Cajón de abejas	CREADO POR A. PARDO	APROBADO POR		
NOMBRE DE PIEZA REVERSIBLE BOTTOM BOARD	CÓDIGO 2	TIPO DE DOCUMENTO ASSEMBY	MATERIAL WOOD	
 <small>OPEN SOURCE ECOLOGY GERMANY</small>	LICENCIA 	NOMBRE DE ARCHIVO REVERSIBLE BOTTOM BOARD.iam	VERSION 1.0	CANTIDAD 1
		ESCALA 1 / 4.5	HOJA 6/28	FECHA 01-10-2020



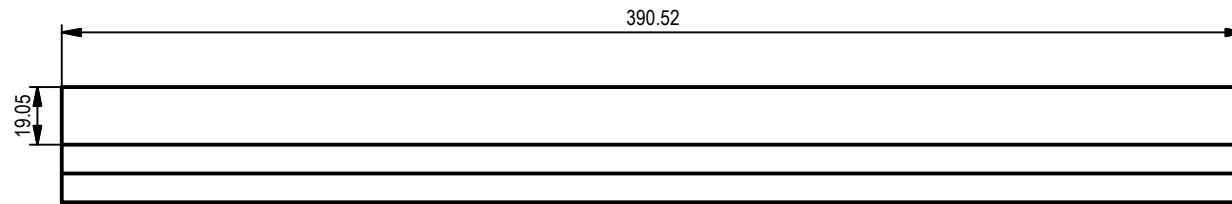
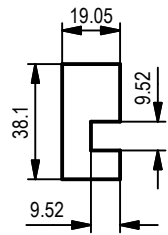
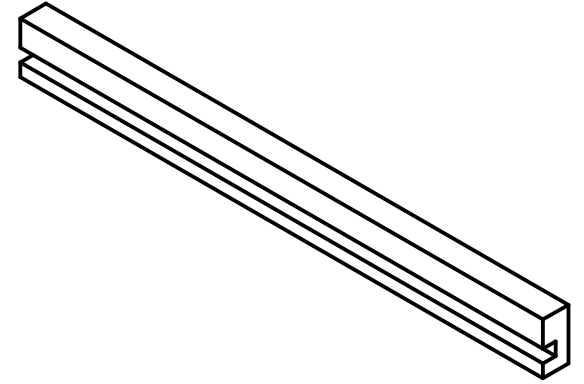

PROYECTO Cajón de abejas	CREADO POR A. PARDO	APROBADO POR			
NOMBRE DE PIEZA REVERSIBLE BOTTOM BOARD A	CÓDIGO 2.1	TIPO DE DOCUMENTO ASSEMBY	MATERIAL WOOD		
	LICENCIA 	NOMBRE DE ARCHIVO REVERSIBLE BOTTOM BOARD A.ipt	VERSION 1.0	CANTIDAD 1	
		ESCALA 1 / 3	HOJA 7/28	FECHA 25-09-2020	



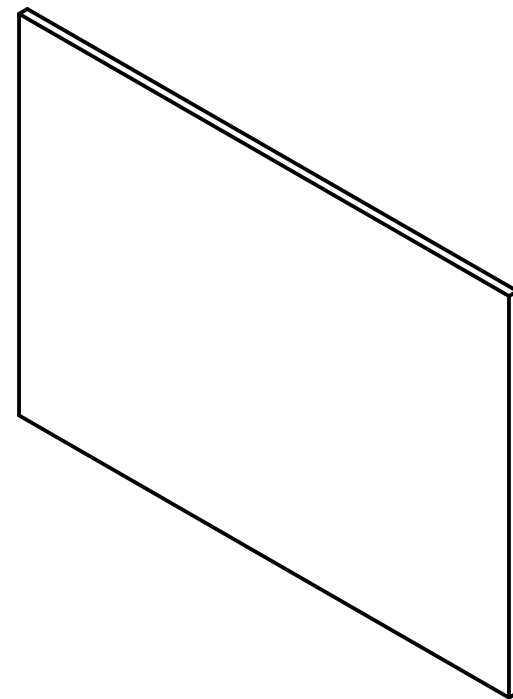
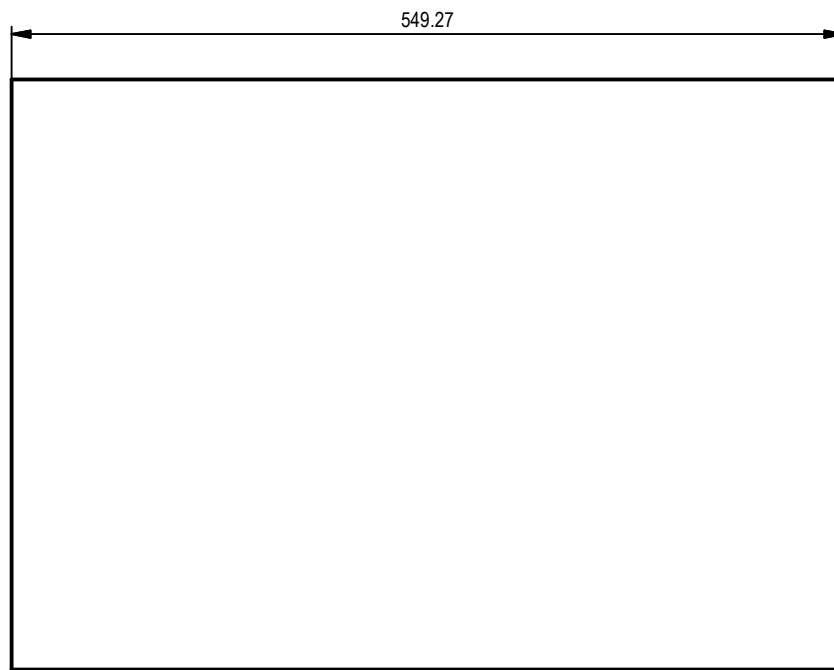
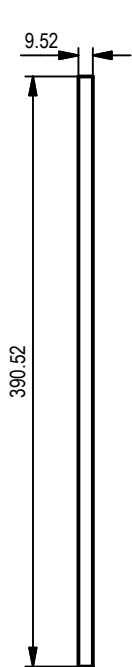

PROYECTO Cajón de abejas	CREADO POR A. PARDO	APROBADO POR			
NOMBRE DE PIEZA REVERSIBLE BOTTOM BOARD B	CÓDIGO 2.2	TIPO DE DOCUMENTO ASSEMBY	MATERIAL WOOD		
	LICENCIA 	NOMBRE DE ARCHIVO REVERSIBLE BOTTOM BOARD B.djt	VERSION 1.0	CANTIDAD 1	
		ESCALA 1 / 2.5	HOJA 8/28	FECHA 25-09-2020	



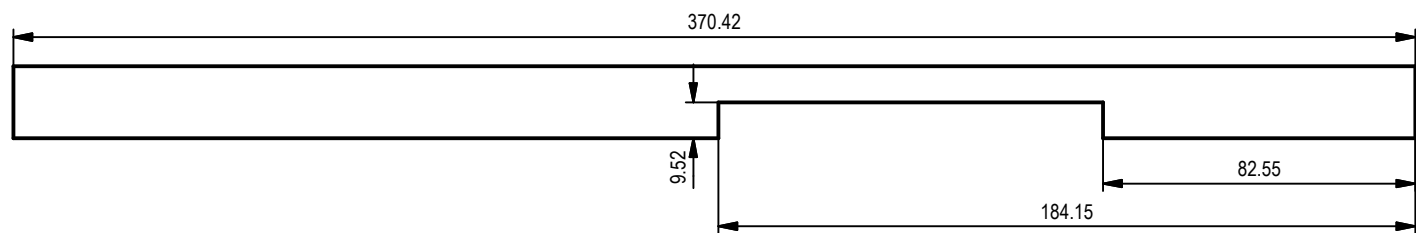
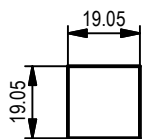
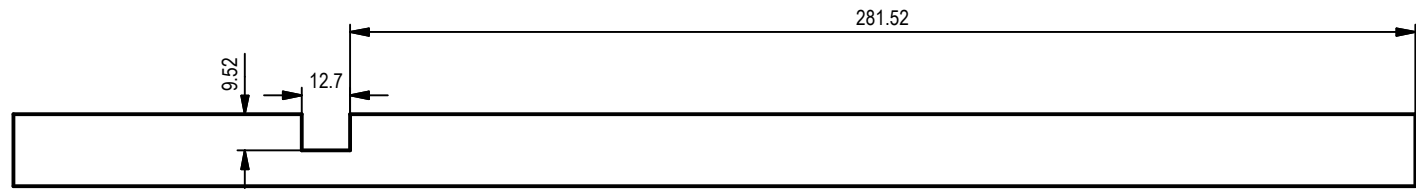
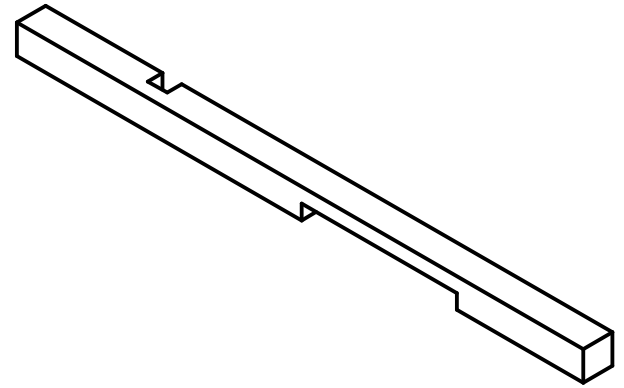

PROYECTO Cajón de abejas	CREADO POR A. PARDO	APROBADO POR			
NOMBRE DE PIEZA REVERSIBLE BOTTOM BOARD C	CÓDIGO 2.3	TIPO DE DOCUMENTO ASSEMBY	MATERIAL WOOD		
	LICENCIA 	NOMBRE DE ARCHIVO REVERSIBLE BOTTOM BOARD C.dwt	VERSION 1.0	CANTIDAD 1	
		ESCALA 1 / 5	HOJA 9/28	FECHA 25-09-2020	



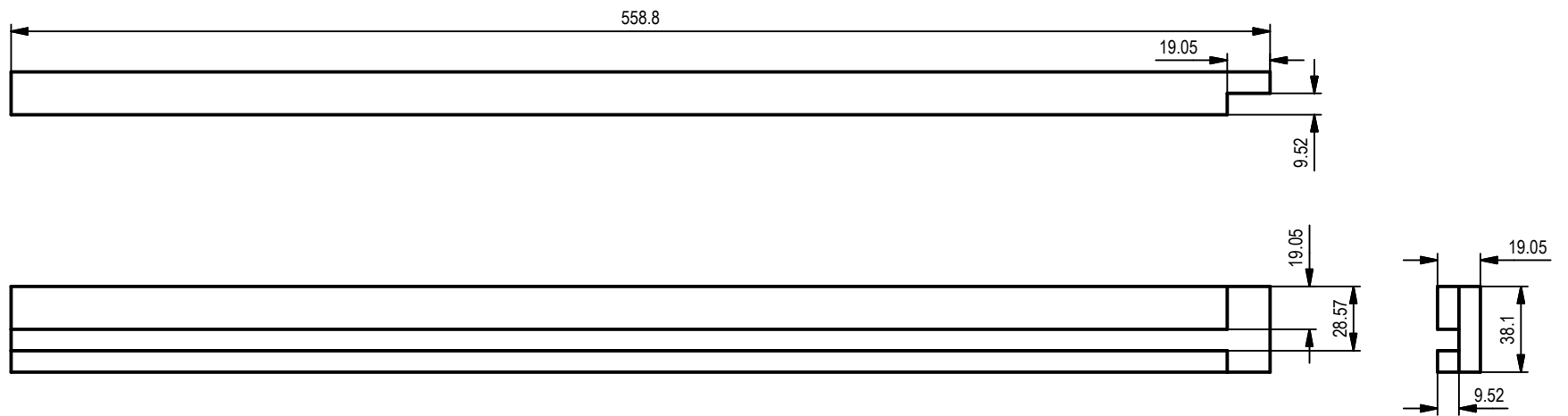
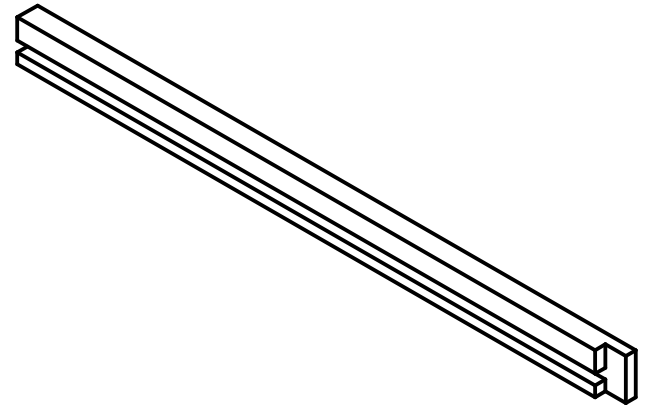

PROYECTO Cajón de abejas	CREADO POR A. PARDO	APROBADO POR		
NOMBRE DE PIEZA REVERSIBLE BOTTOM BOARD D	CÓDIGO 2.4	TIPO DE DOCUMENTO ASSEMBY	MATERIAL WOOD	
	LICENCIA 	NOMBRE DE ARCHIVO REVERSIBLE BOTTOM BOARD D.dwg	VERSION 1.0	CANTIDAD 1
		ESCALA 1 / 2	HOJA 10/28	FECHA 25-09-2020



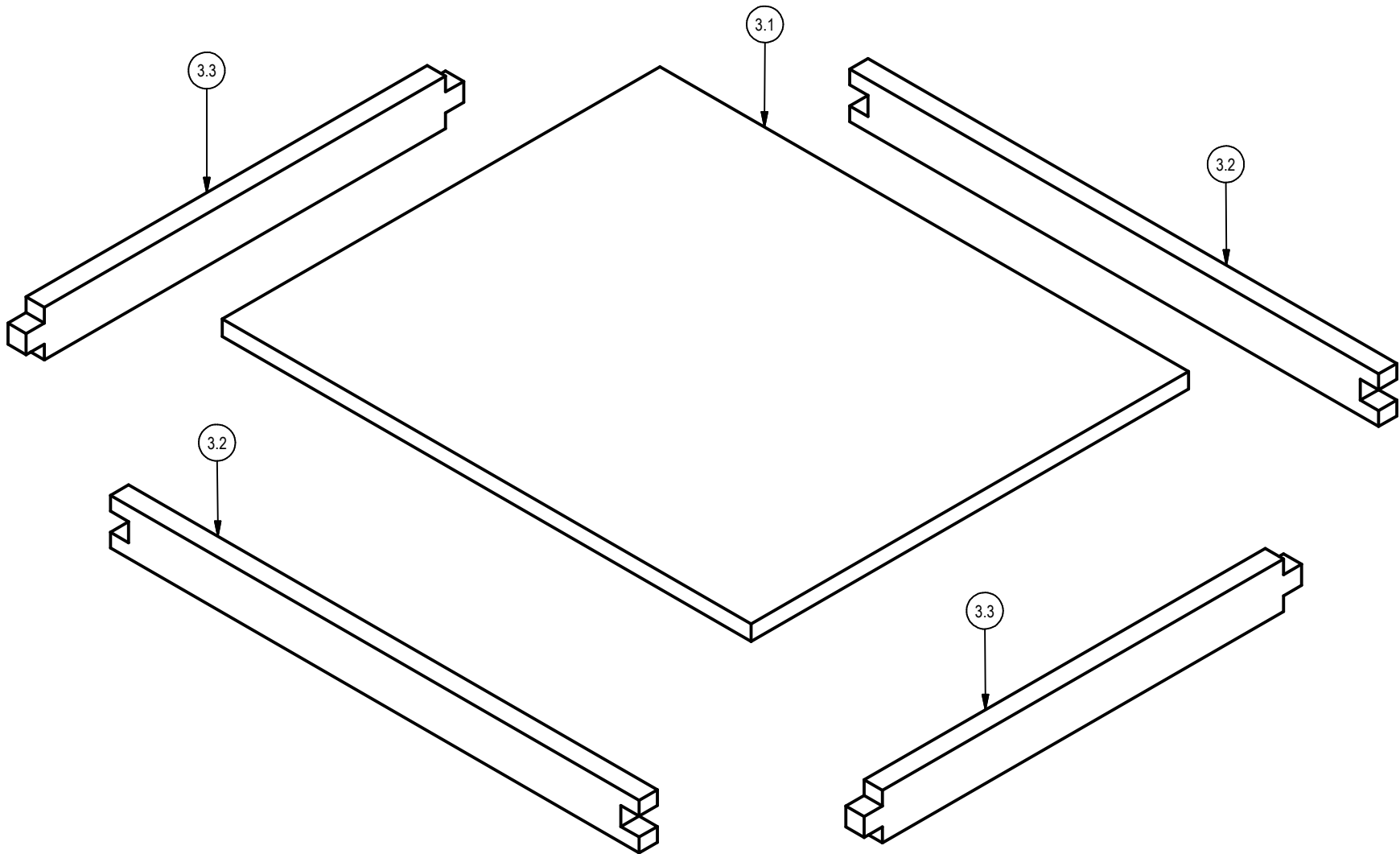

PROYECTO Cajón de abejas	CREADO POR A. PARDO	APROBADO POR			
NOMBRE DE PIEZA REVERSIBLE BOTTOM BOARD E	CÓDIGO 2.5	TIPO DE DOCUMENTO ASSEMBY	MATERIAL WOOD		
	LICENCIA 	NOMBRE DE ARCHIVO REVERSIBLE BOTTOM BOARD E.ipt	VERSION 1.0	CANTIDAD 1	
		ESCALA 1 / 3	HOJA 11/28	FECHA 25-09-2020	



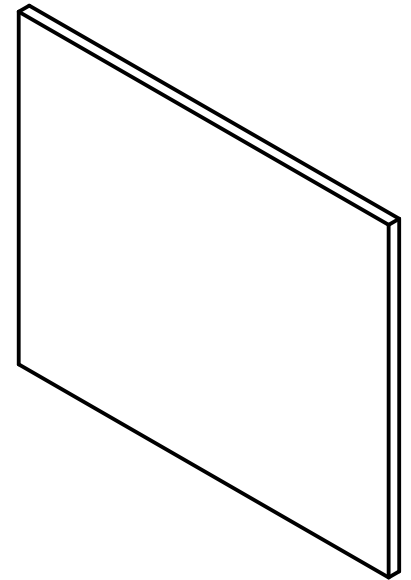
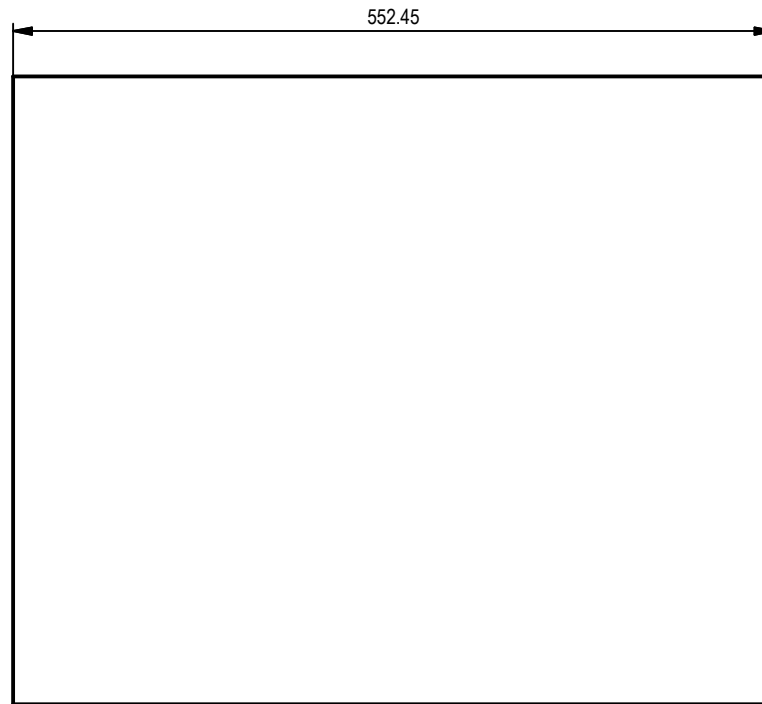
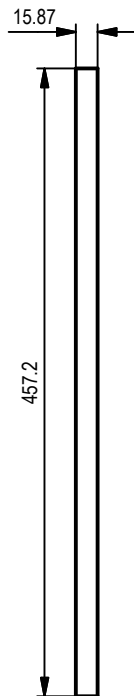

PROYECTO Cajón de abejas	CREADO POR A. PARDO	APROBADO POR		
NOMBRE DE PIEZA OUTER COVER	CÓDIGO 3	TIPO DE DOCUMENTO ASSEMBY	MATERIAL WOOD	
 <small>OPEN SOURCE ECOLOGY GERMANY</small>	LICENCIA 	NOMBRE DE ARCHIVO OUTER COVER.iam	VERSION 1.0	CANTIDAD 1
		ESCALA 1 / 4.5	HOJA 12/28	FECHA 25-09-2020



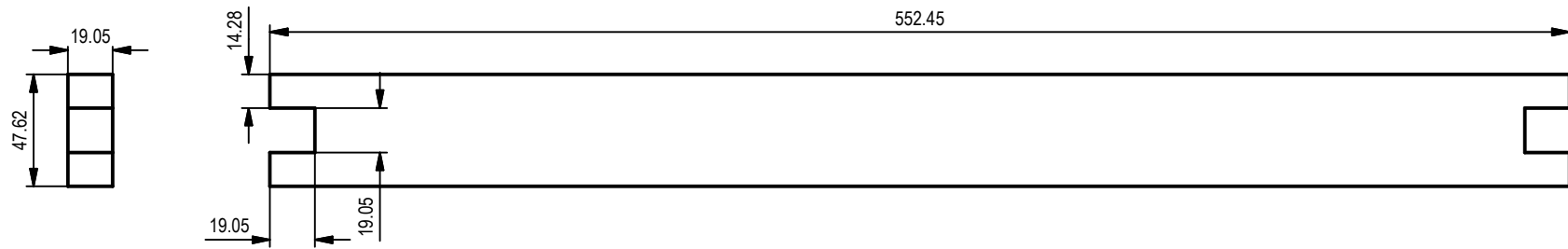
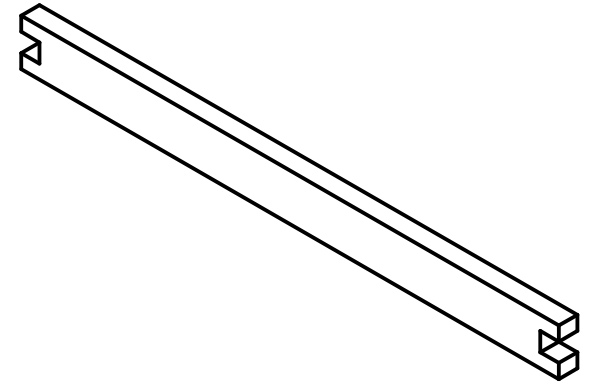

PROYECTO Cajón de abejas	CREADO POR A. PARDO	APROBADO POR		
NOMBRE DE PIEZA OUTER COVER A	CÓDIGO 3.1	TIPO DE DOCUMENTO ASSEMBY	MATERIAL WOOD	
 <small>OPEN SOURCE ECOLOGY GERMANY</small>	LICENCIA 	NOMBRE DE ARCHIVO OUTER COVER A.ipt	VERSION 1.0	CANTIDAD 1
		ESCALA 1 / 5.5	HOJA 13/28	FECHA 25-09-2020



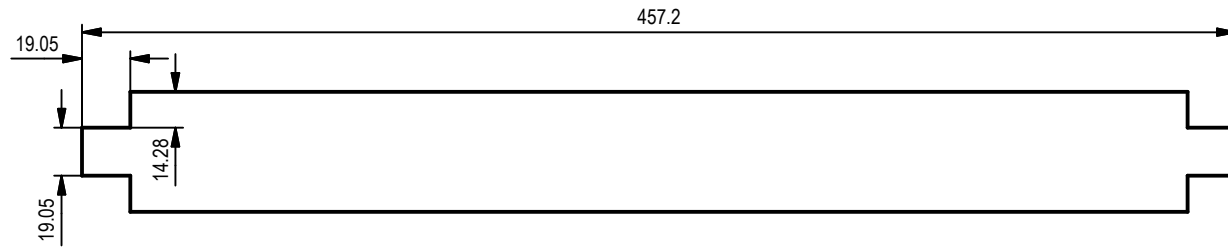
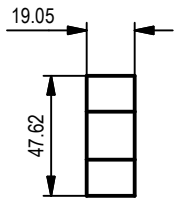
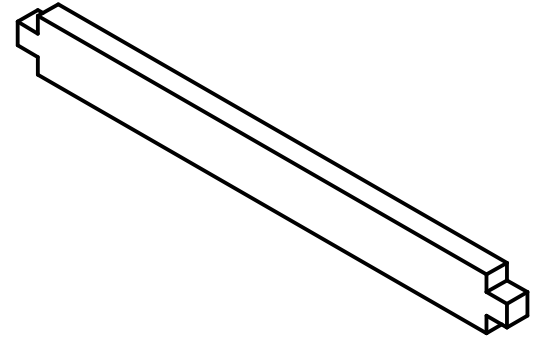

PROYECTO Cajón de abejas	CREADO POR A. PARDO	APROBADO POR		
NOMBRE DE PIEZA OUTER COVER B	CÓDIGO 3.2	TIPO DE DOCUMENTO ASSEMBY	MATERIAL WOOD	
	LICENCIA 	NOMBRE DE ARCHIVO OUTER COVER B.ipt	VERSION 1.0	CANTIDAD 1
		ESCALA 1 / 3	HOJA 14/28	FECHA 25-09-2020



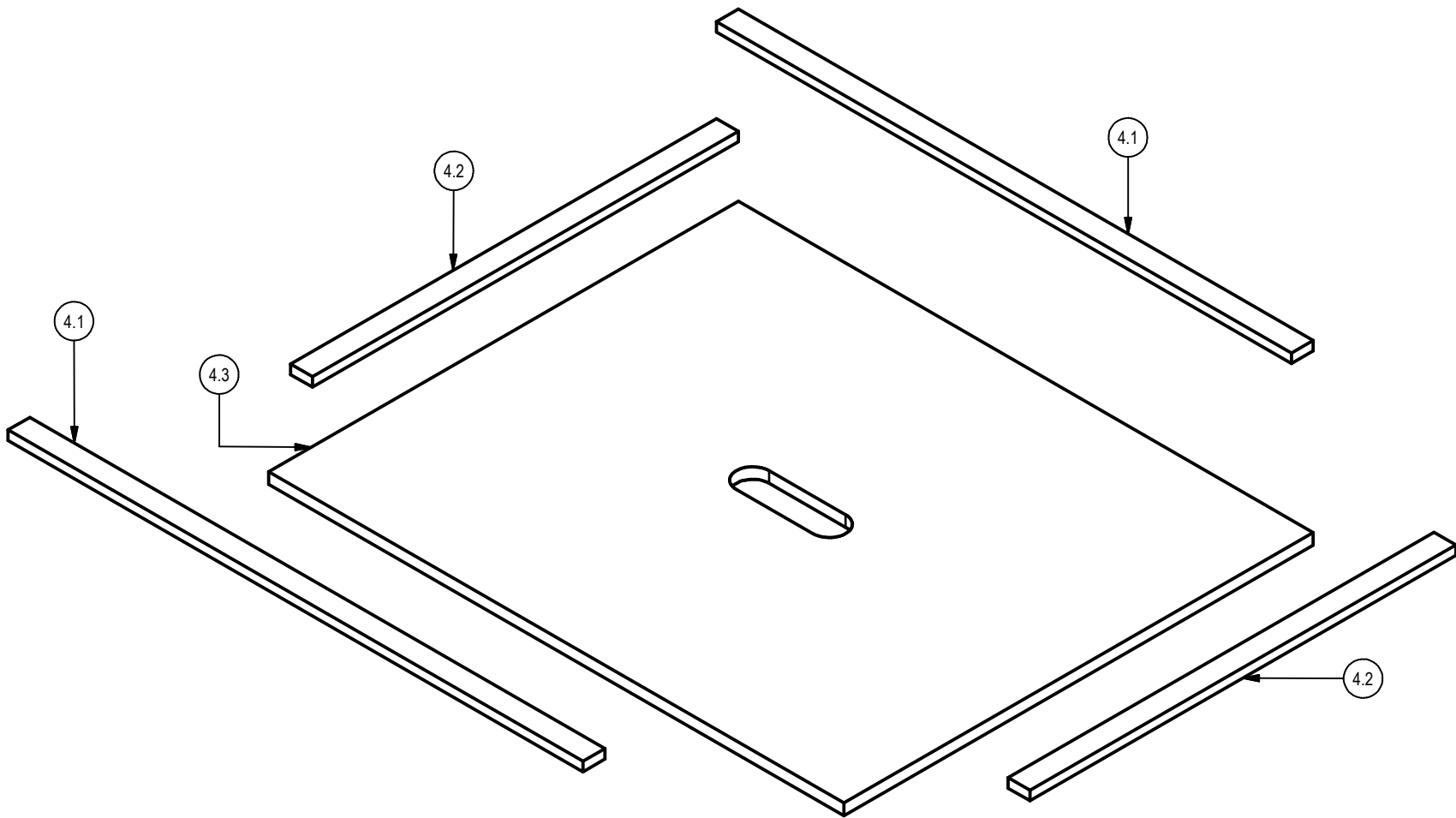

PROYECTO Cajón de abejas	CREADO POR A. PARDO	APROBADO POR		
NOMBRE DE PIEZA OUTER COVER C	CÓDIGO 3.3	TIPO DE DOCUMENTO ASSEMBY	MATERIAL WOOD	
 <small>OPEN SOURCE ECOLOGY GERMANY</small>	LICENCIA 	NOMBRE DE ARCHIVO OUTER COVER C.ipt	VERSION 1.0	CANTIDAD 1
		ESCALA 1 / 3	HOJA 15/28	FECHA 25-09-2020

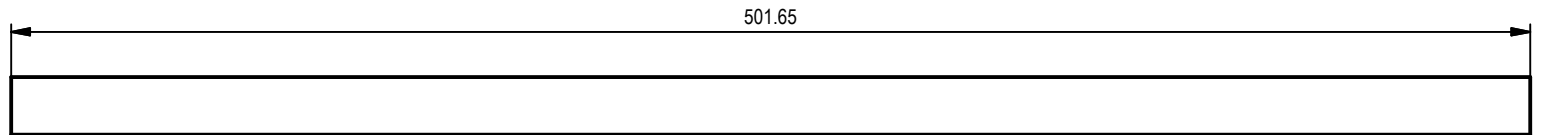
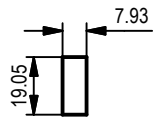
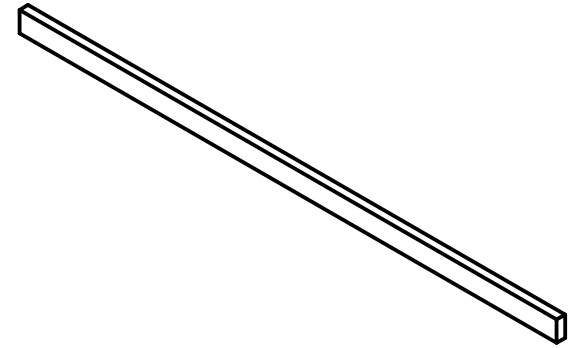

PROYECTO Cajón de abejas	CREADO POR A. PARDO	APROBADO POR		
NOMBRE DE PIEZA INNER COVER	CÓDIGO 4	TIPO DE DOCUMENTO ASSEMBY	MATERIAL WOOD	
 <small>OPEN SOURCE ECOLOGY GERMANY</small>	LICENCIA 	NOMBRE DE ARCHIVO INNER COVER.iam	VERSION 1.0	CANTIDAD 1
		ESCALA 1 / 4	HOJA 16/28	FECHA 25-09-2020



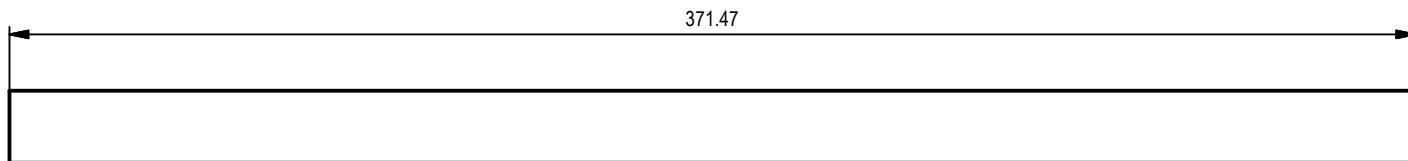
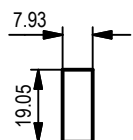
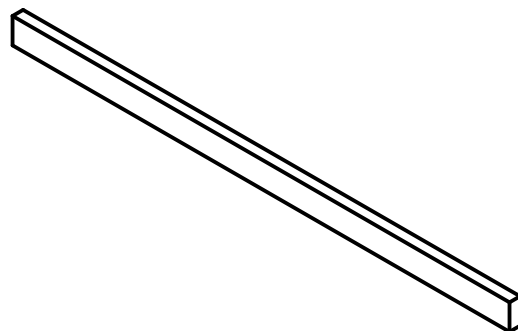

PROYECTO Cajón de abejas	CREADO POR A. PARDO	APROBADO POR		
NOMBRE DE PIEZA INNER COVER A	CÓDIGO 4.1	TIPO DE DOCUMENTO ASSEMBY	MATERIAL WOOD	
 <small>OPEN SOURCE ECOLOGY GERMANY</small>	LICENCIA 	NOMBRE DE ARCHIVO INNER COVER A.ipt	VERSION 1.0	CANTIDAD 1
		ESCALA 1 / 2.5	HOJA 17/28	FECHA 25-09-2020

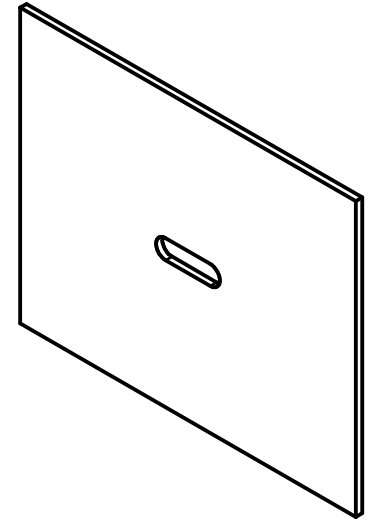
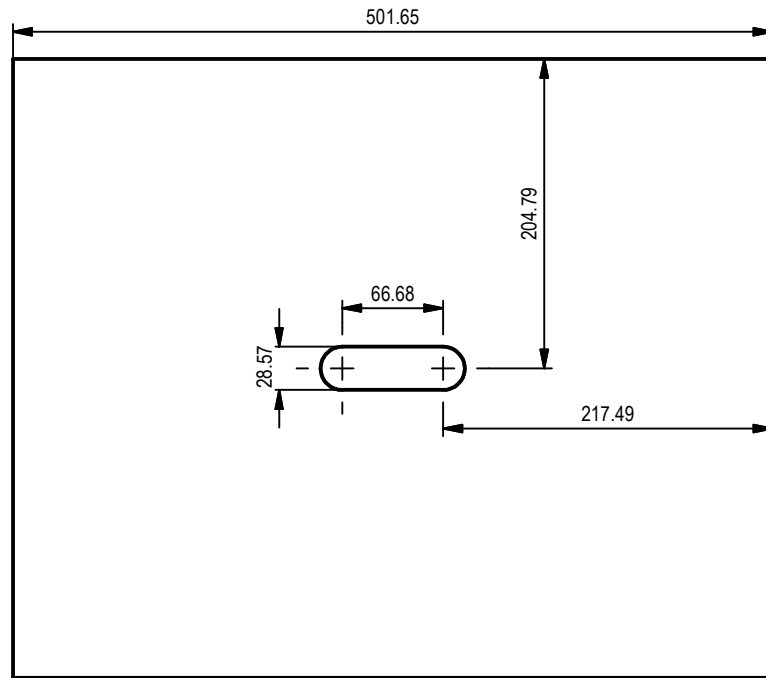
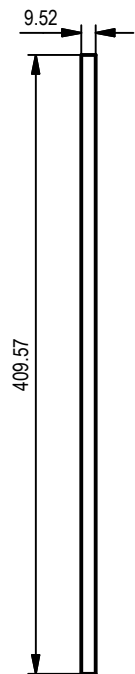

PROYECTO Cajón de abejas	CREADO POR A. PARDO	APROBADO POR		
NOMBRE DE PIEZA INNER COVER B	CÓDIGO 4.2	TIPO DE DOCUMENTO ASSEMBY	MATERIAL WOOD	
 <small>OPEN SOURCE ECOLOGY GERMANY</small>	LICENCIA 	NOMBRE DE ARCHIVO INNER COVER B.ipt	VERSION 1.0	CANTIDAD 1
		ESCALA 1 / 2	HOJA 18/28	FECHA 25-09-2020



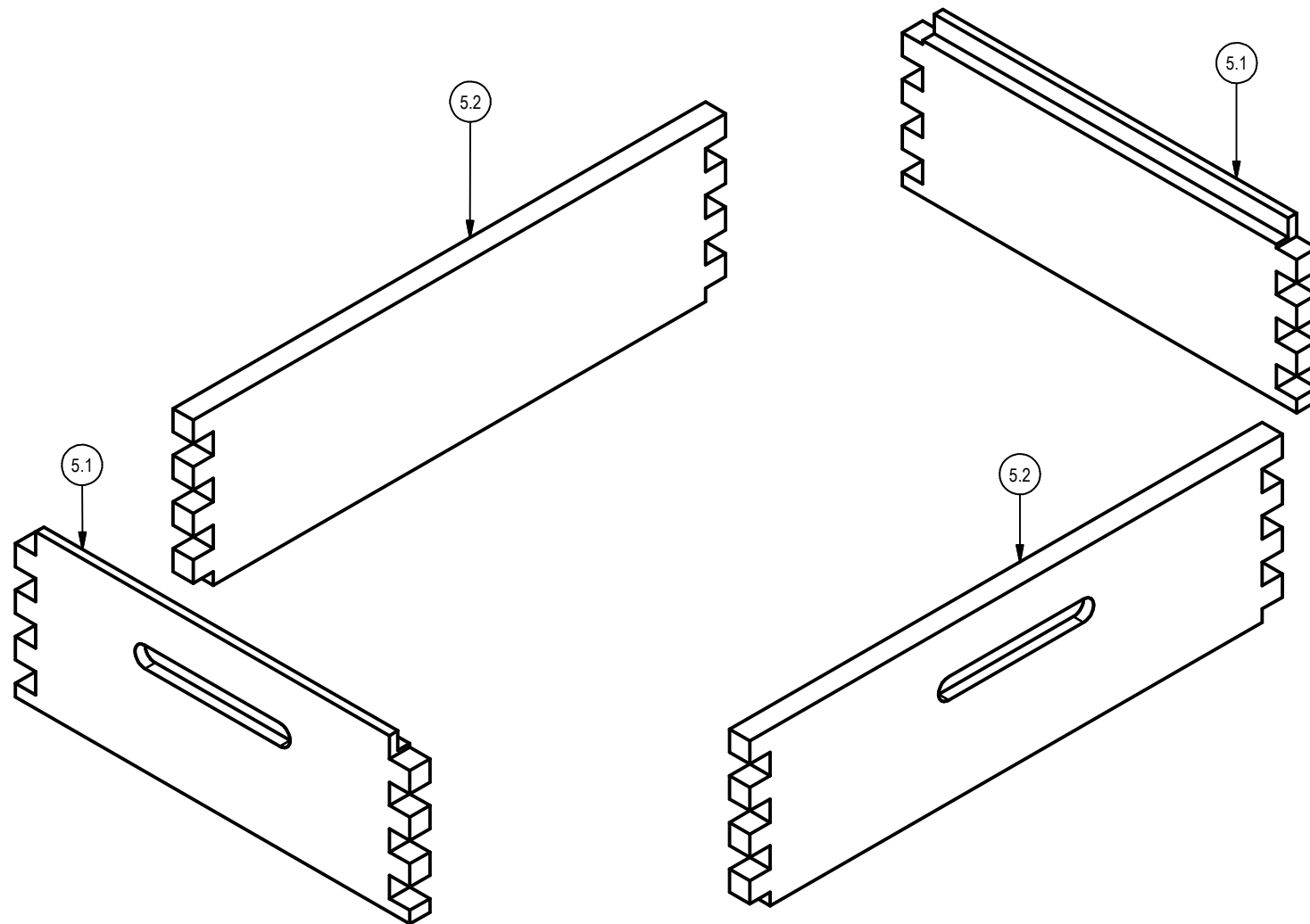

PROYECTO Cajón de abejas	CREADO POR A. PARDO	APROBADO POR		
NOMBRE DE PIEZA INNER COVER C	CÓDIGO 4.3	TIPO DE DOCUMENTO ASSEMBY	MATERIAL WOOD	
 <small>OPEN SOURCE ECOLOGY GERMANY</small>	LICENCIA 	NOMBRE DE ARCHIVO INNER COVER C.ipt	VERSION 1.0	CANTIDAD 1
		ESCALA 1 / 5	HOJA 19/28	FECHA 25-09-2020

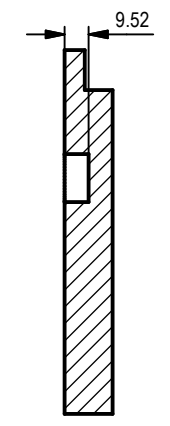
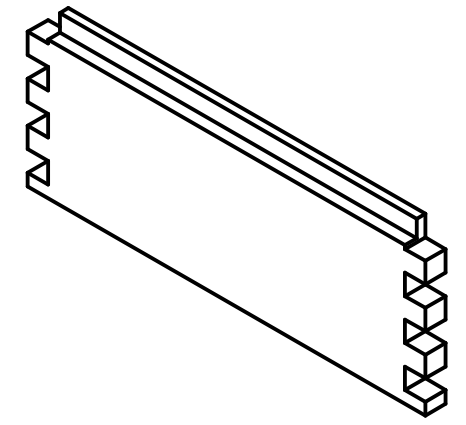
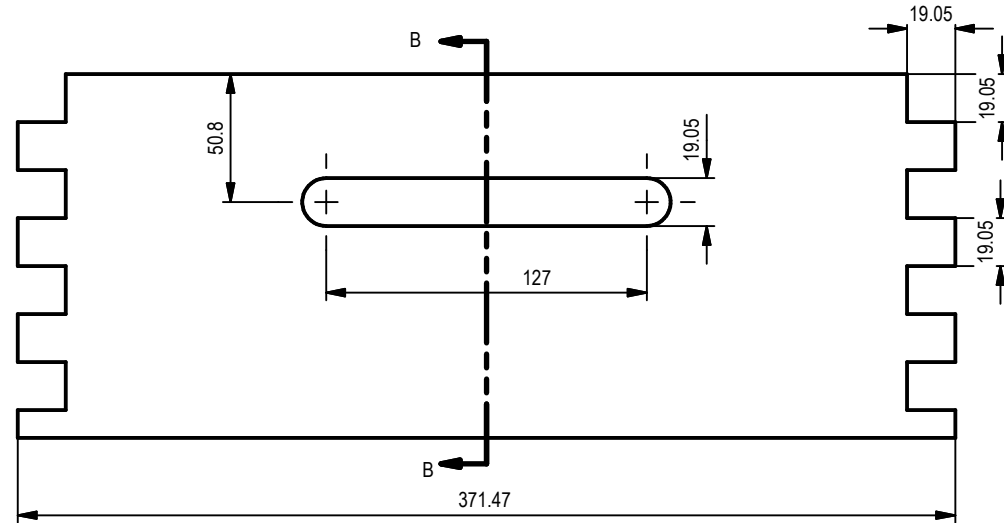
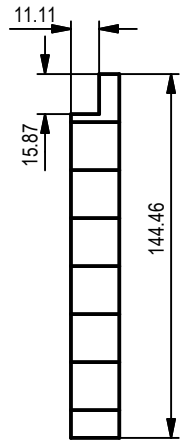

PROYECTO Cajón de abejas	CREADO POR A. PARDO	APROBADO POR		
NOMBRE DE PIEZA SHALLOW SUPER	CÓDIGO 5	TIPO DE DOCUMENTO ASSEMBY	MATERIAL WOOD	
	LICENCIA 	NOMBRE DE ARCHIVO SHALLOW SUPER.iam	VERSION 1.0	CANTIDAD 1
		ESCALA 1 : 4.5	HOJA 20/28	FECHA 25-09-2020



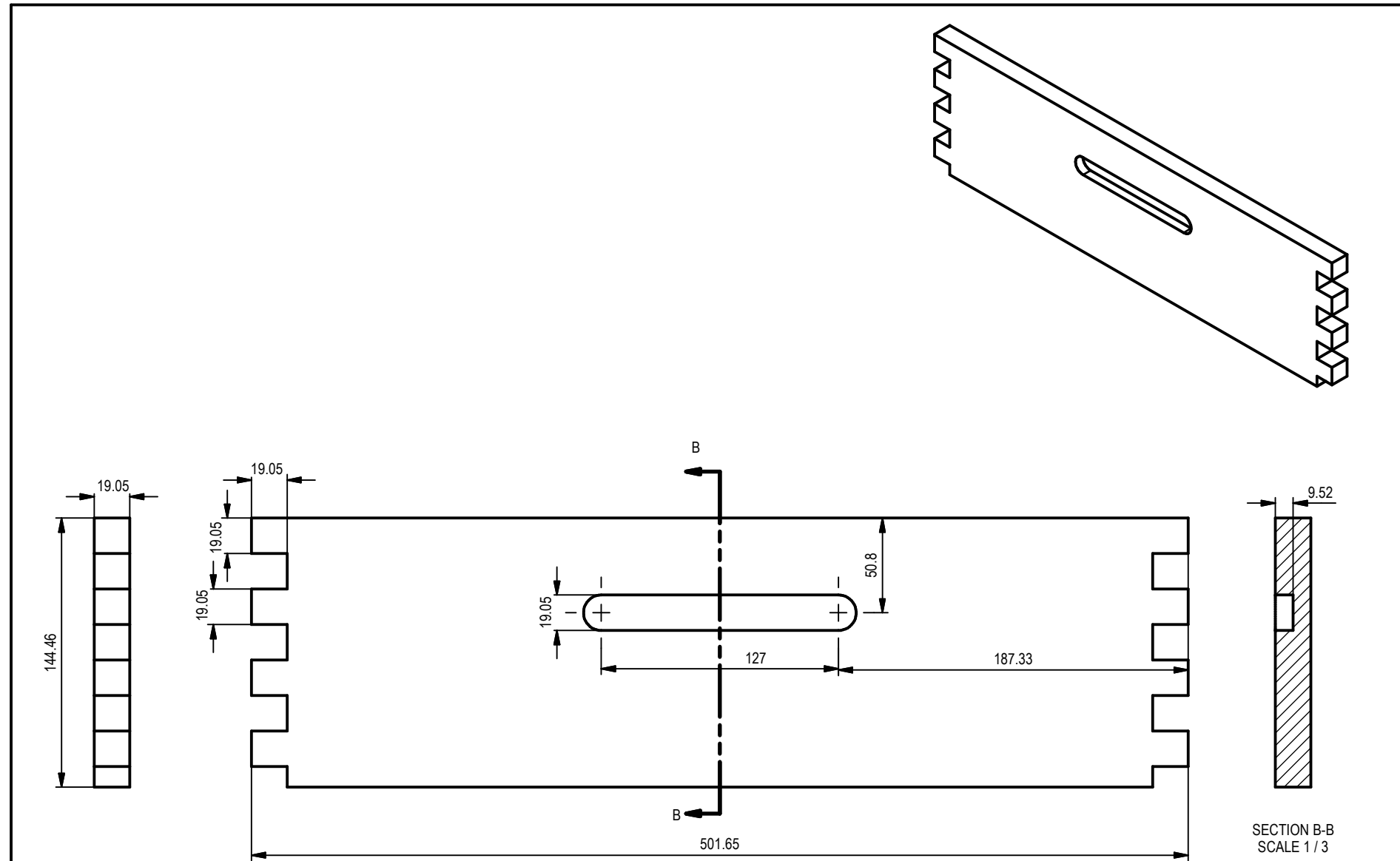

SECTION ME-ME
SCALE 1 / 3

PROYECTO Cajón de abejas	CREADO POR A. PARDO	APROBADO POR		
NOMBRE DE PIEZA SHALLOW SUPER A	CÓDIGO 5.1	TIPO DE DOCUMENTO ASSEMBY	MATERIAL WOOD	
	LICENCIA 	NOMBRE DE ARCHIVO SHALLOW SUPER A.ipt	VERSION 1.0	CANTIDAD 1
		ESCALA 1 / 3	HOJA 21/28	FECHA 25-09-2020



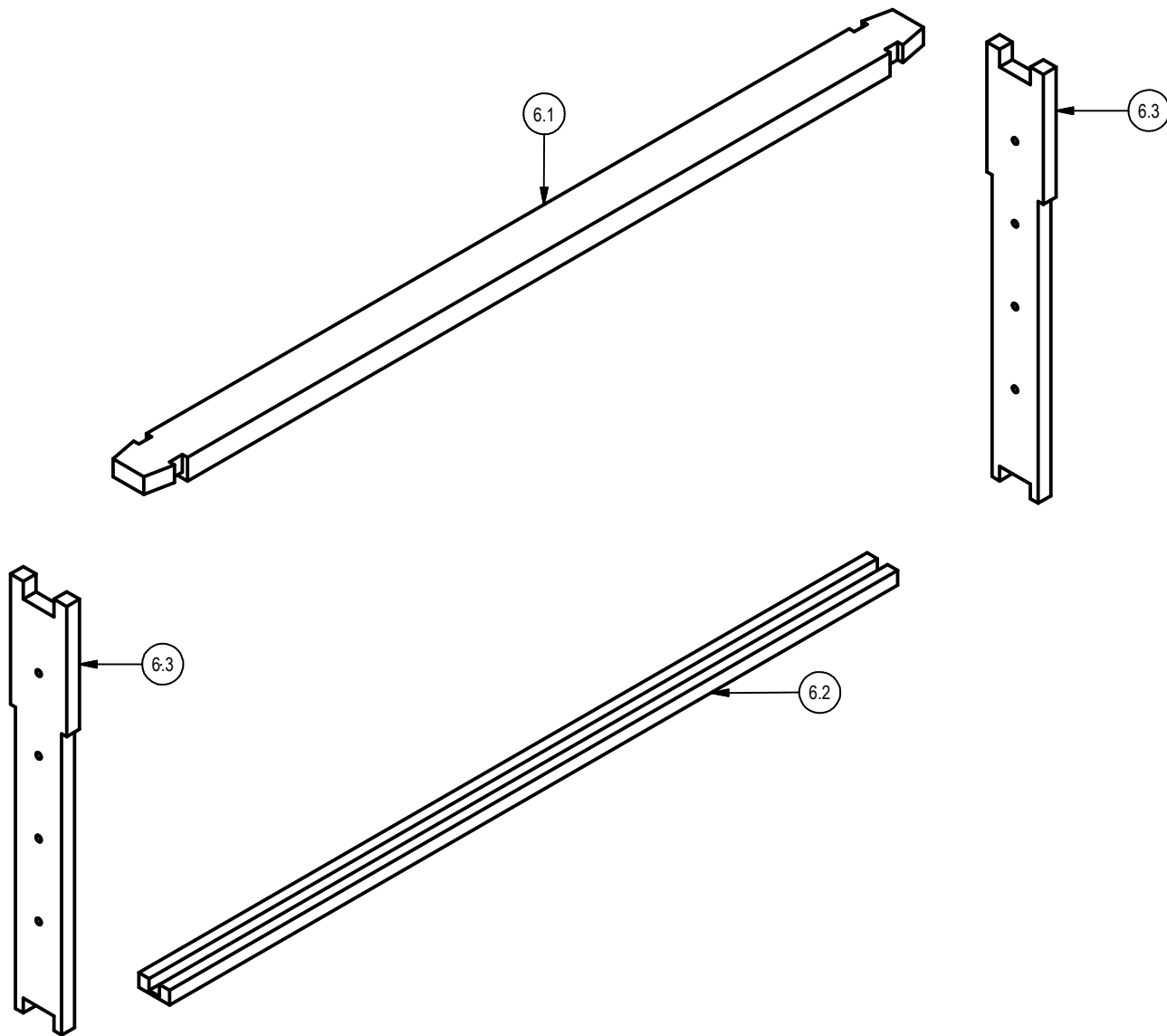

PROYECTO Cajón de abejas	CREADO POR A. PARDO	APROBADO POR		
NOMBRE DE PIEZA SHALLOW SUPER B	CÓDIGO 5.2	TIPO DE DOCUMENTO ASSEMBY	MATERIAL WOOD	
 OPEN SOURCE ECOLOGY GERMANY	LICENCIA 	NOMBRE DE ARCHIVO SHALLOW SUPER B.ipt	VERSION 1.0	CANTIDAD 1
		ESCALA 1 / 3	HOJA 22/28	FECHA 25-09-2020



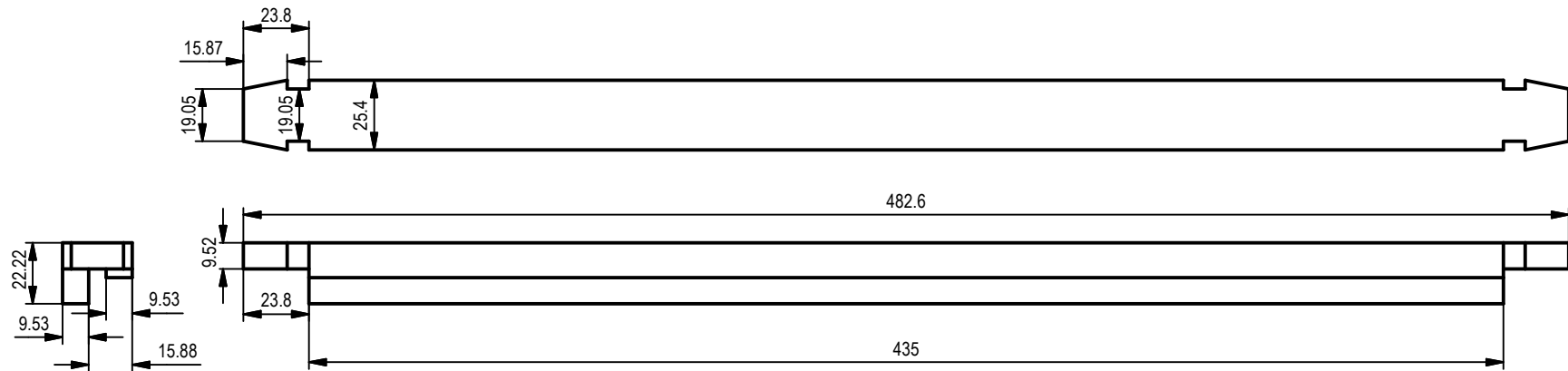
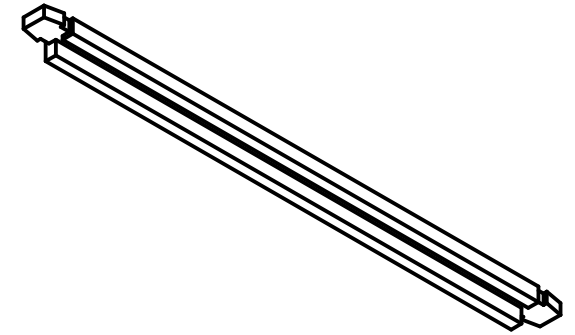

PROYECTO Cajón de abejas	CREADO POR A. PARDO	APROBADO POR		
NOMBRE DE PIEZA BROOD FRAME	CÓDIGO 6	TIPO DE DOCUMENTO ASSEMBY	MATERIAL WOOD	
 OPEN SOURCE ECOLOGY GERMANY	LICENCIA 	NOMBRE DE ARCHIVO BROOD FRAME.iam	VERSION 1.0	CANTIDAD 1
		ESCALA 1 : 3	HOJA 23/28	FECHA 25-09-2020

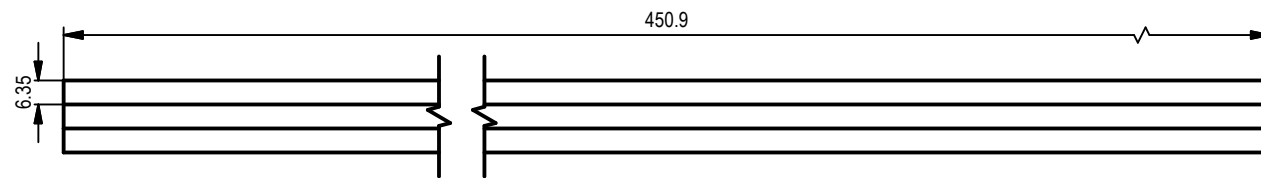
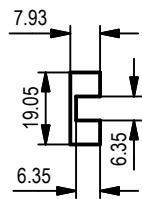
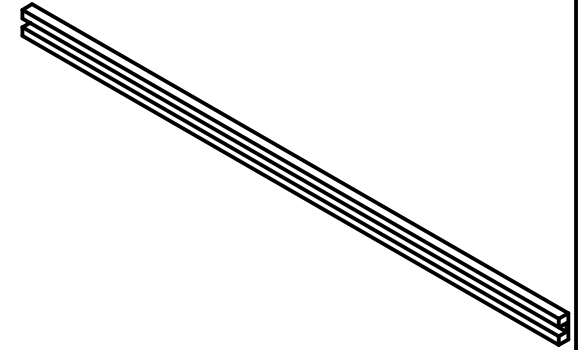

PROYECTO Cajón de abejas	CREADO POR A. PARDO	APROBADO POR		
NOMBRE DE PIEZA BROOD FRAME A	CÓDIGO 6.1	TIPO DE DOCUMENTO ASSEMBY	MATERIAL WOOD	
 <small>OPEN SOURCE ECOLOGY GERMANY</small>	LICENCIA 	NOMBRE DE ARCHIVO BROOD FRAME A.ipt	VERSION 1.0	CANTIDAD 1
		ESCALA 1 / 2.5	HOJA 24/28	FECHA 25-09-2020



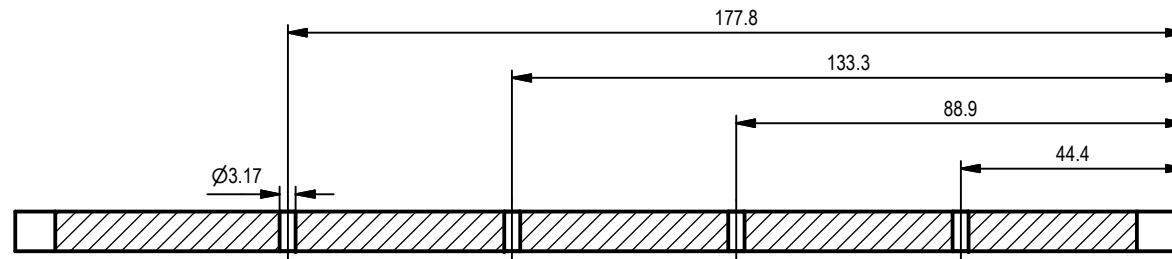
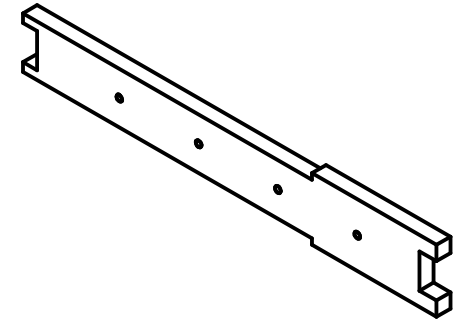

PROYECTO Cajón de abejas	CREADO POR A. PARDO	APROBADO POR		
NOMBRE DE PIEZA BROOD FRAME B	CÓDIGO 6.2	TIPO DE DOCUMENTO ASSEMBY	MATERIAL WOOD	
 <small>OPEN SOURCE ECOLOGY GERMANY</small>	LICENCIA 	NOMBRE DE ARCHIVO BROOD FRAME B.ipt	VERSION 1.0	CANTIDAD 1
		ESCALA 1 / 2	HOJA 25/28	FECHA 25-09-2020



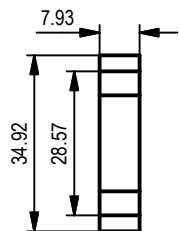
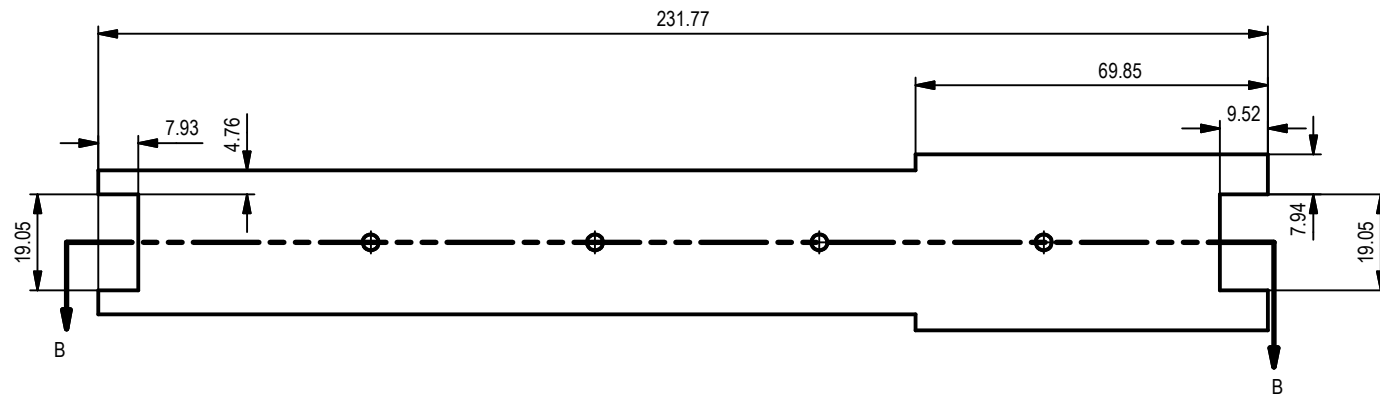

SECTION B-B
SCALE 1 / 1.5

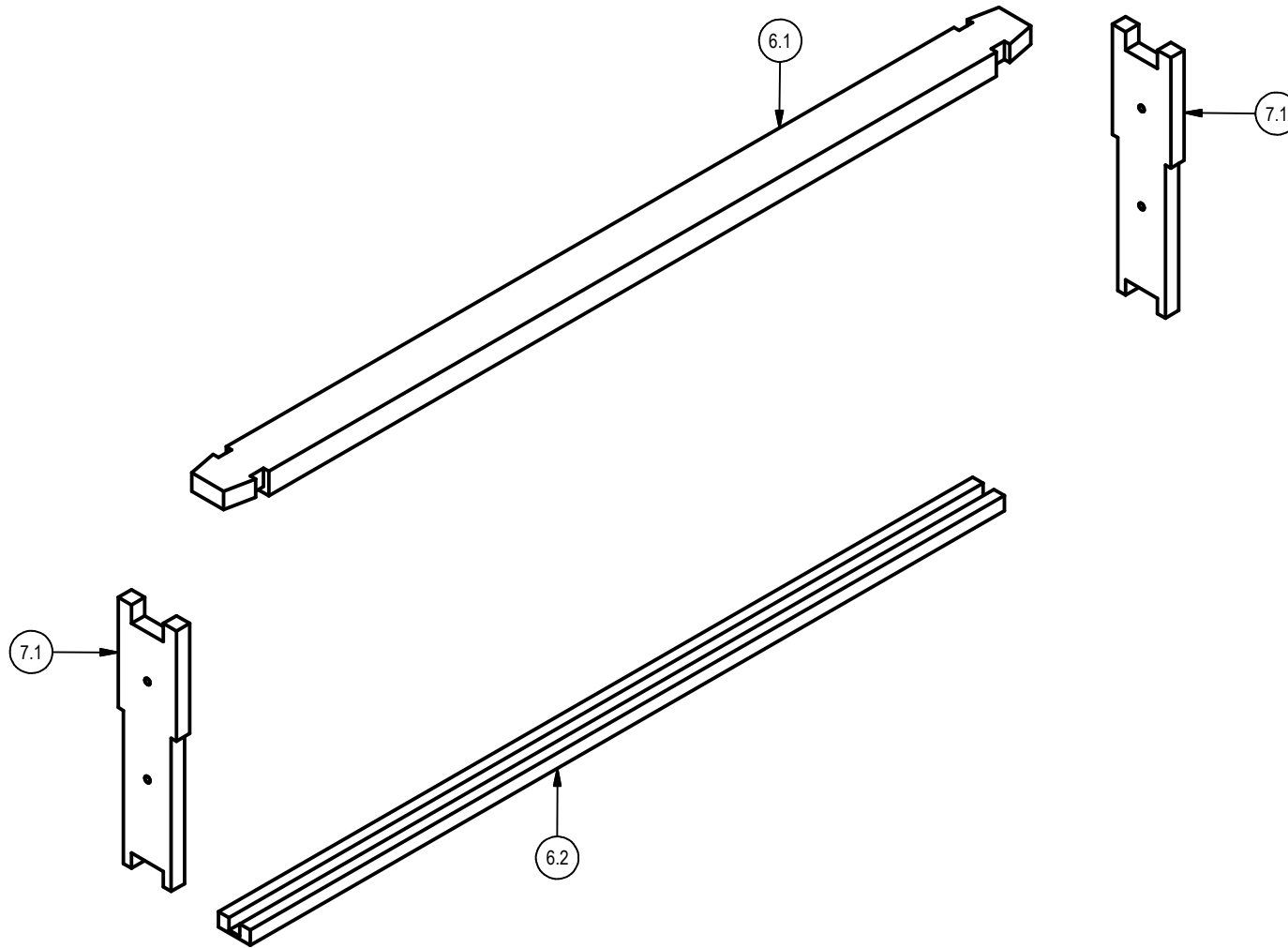

PROYECTO Cajón de abejas	CREADO POR A. PARDO	APROBADO POR		
NOMBRE DE PIEZA BROOD FRAME C	CÓDIGO 6.3	TIPO DE DOCUMENTO ASSEMBY	MATERIAL WOOD	
 OPEN SOURCE ECOLOGY GERMANY	LICENCIA 	NOMBRE DE ARCHIVO BROOD FRAME C.ipt	VERSION 1.0	CANTIDAD 1
		ESCALA 1 / 1.5	HOJA 26/28	FECHA 25-09-2020



PROYECTO Cajón de abejas	CREADO POR A. PARDO	APROBADO POR		
NOMBRE DE PIEZA SHALLOW SUPER FRAME	CÓDIGO 7	TIPO DE DOCUMENTO ASSEMBY	MATERIAL WOOD	
 <small>OPEN SOURCE ECOLOGY GERMANY</small>	LICENCIA 	NOMBRE DE ARCHIVO SHALLOW SUPER FRAME.iam	VERSION 1.0	CANTIDAD 1
		ESCALA 1 / 3	HOJA 27/28	FECHA 25-09-2020

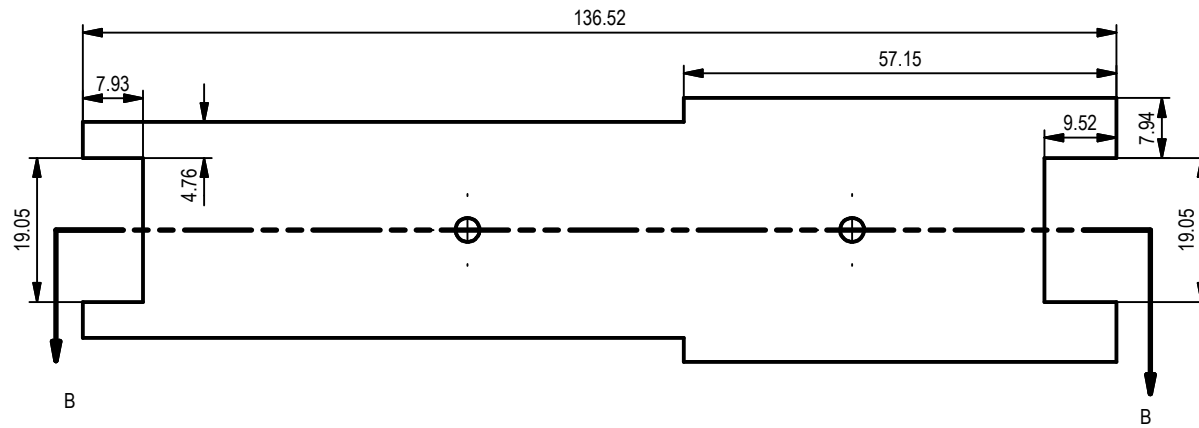
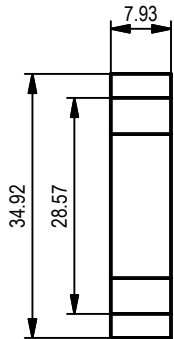
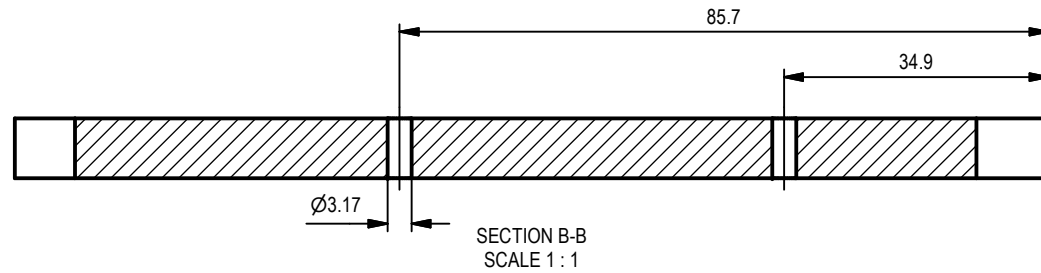
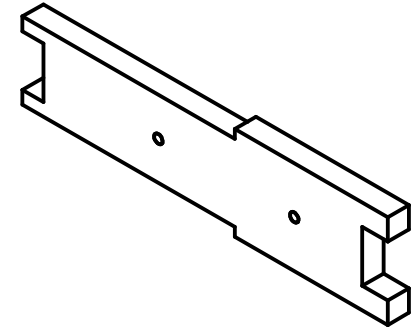

PROYECTO Cajón de abejas	CREADO POR A. PARDO	APROBADO POR		
NOMBRE DE PIEZA SHALLOW SUPER FRAME A	CÓDIGO 7.1	TIPO DE DOCUMENTO ASSEMBY	MATERIAL WOOD	
 OPEN SOURCE ECOLOGY GERMANY	LICENCIA 	NOMBRE DE ARCHIVO SHALLOW SUPER FRAME A.ipt	VERSION 1.0	CANTIDAD 1
		ESCALA 1:1	HOJA 28/28	FECHA 25-09-2020