

PROJEKT		ERSTELLT VON	GENEHMIGT VON	DATE	VERSION
Reagenzglas-Stand		E. CEBALLOS	A. MORILLO	15-05-2021	1.0
TEIL-NAME		DATEI-NAME			TEIL-CODE
3D-Ansicht		Test_Tube_Stand.iam			A
ENTWICKELT VON	UMGESTALTET VON	UNTERSTUETZT DURCH	DOK. TYP	WERKSTOFF	MENGE
			ASSEMBLY		
AMERICAN PEACE CORPS		OHO e.V.		LIZENZ	SCALE
		CC-BY-SA 4.0		1:4	SEITE
					1 / 9

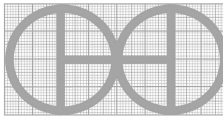
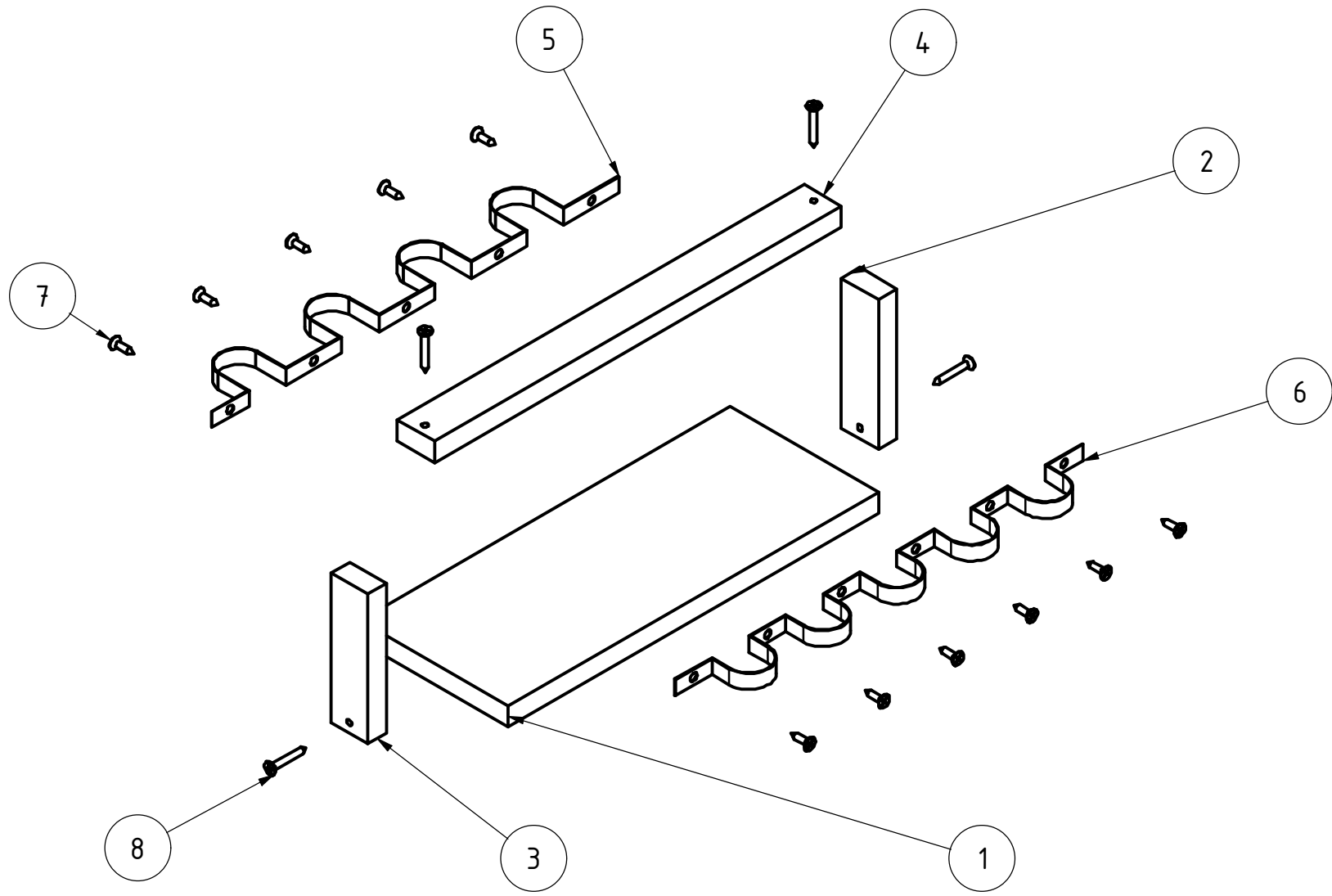
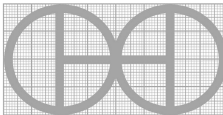

PROJEKT		ERSTELLT VON		GENEHMIGT VON		DATE	VERSION
Reagenzglas-Stand		E. CEBALLOS		A. MORILLO		15-05-2021	1.0
TEIL-NAME				DATEI-NAME			TEIL-CODE
3D-Ansicht				Test_Tube_Stand.iam			A
ENTWICKELT VON		UMGESTALTET VON		UNTERSTUETZT DURCH		DOK. TYP	WERKSTOFF
						ASSEMBLY	
AMERICAN PEACE CORPS OHO e.V.				CC-BY-SA 4.0		SCALE	SEITE
						1:3	2 / 9

PARTS LIST

POS	QTY	TEIL NAME	DATEI-NAME	TEIL-TYP	SPEZIFIKATIONEN	SEITE
A		3D-Ansicht	Test_Tube_Stand.iam			1-2
B		Teileliste				3
1	1	Basis	base.ipt	Production	Holz, Dicke 1/2	4
2	1	Vertikale_Halterung_1	Vertical_support_1.ipt	Production	Holz, Dicke 1/2	5
3	1	Vertikale_Halterung_2	Vertical_support_2.ipt	Production	Holz, Dicke 1/2	6
4	1	Oberer Teil	Upper_part.ipt	Production	Holz, Dicke 1/2	7
5	1	Band_1	Band_1.ipt	Production	Rostfreier Stahl 3/8" x 0,64 mm	8
6	1	Band_2	Band_2.ipt	Production	Rostfreier Stahl 3/8" x 0,64 mm	9
7	11	Kurze Schraube		Standard	DIN EN ISO 7050 - C-H ST3,5x13 C	
8	4	Lange Schraube		Standard	DIN EN ISO 7050 - C-H ST3,5x32 C	

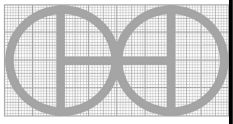
PROJEKT		ERSTELLT VON	GENEHMIGT VON	DATE	VERSION
Reagenzglas-Stand		E. CEBALLOS	A. MORILLO	15-05-2021	1.0
TEIL-NAME		DATEI-NAME			TEIL-CODE
Teileliste					B
ENTWICKELT VON	UMGESTALTET VON	UNTERSTUETZT DURCH	DOK. TYP	WERKSTOFF	MENGE
			PART LIST		
AMERICAN PEACE CORPS		OHO e.V.	LIZENZ	SCALE	SEITE
			CC-BY-SA 4.0		3 / 9

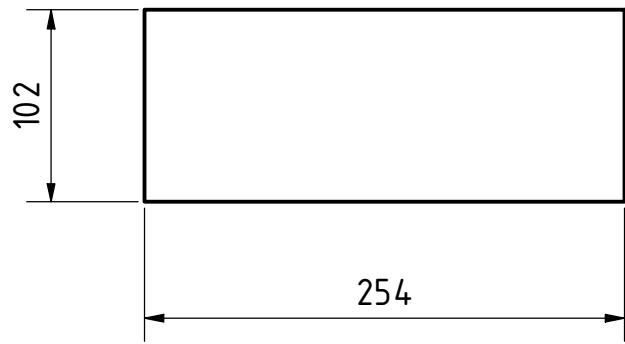
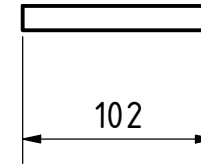
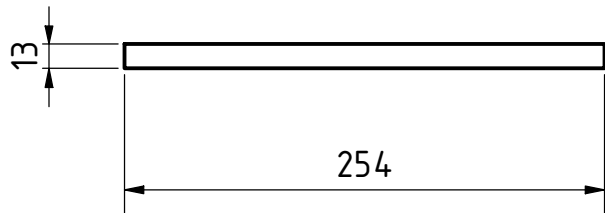

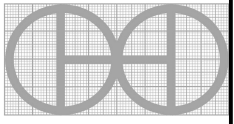
PROJEKT		ERSTELLT VON	GENEHMIGT VON	DATE	VERSION
Reagenzglas-Stand		E. CEBALLOS	A. MORILLO	15-05-2021	1.0
TEIL-NAME		DATEI-NAME			TEIL-CODE
Basis		base.ipt			1
ENTWICKELT VON	UMGESTALTET VON	UNTERSTUETZT DURCH	DOK. TYP	WERKSTOFF	MENGE
			ASSEMBLY	Holz	1
AMERICAN PEACE CORPS		OHO e.V.	LIZENZ	SCALE	SEITE
			CC-BY-SA 4.0	1:4	4 / 9

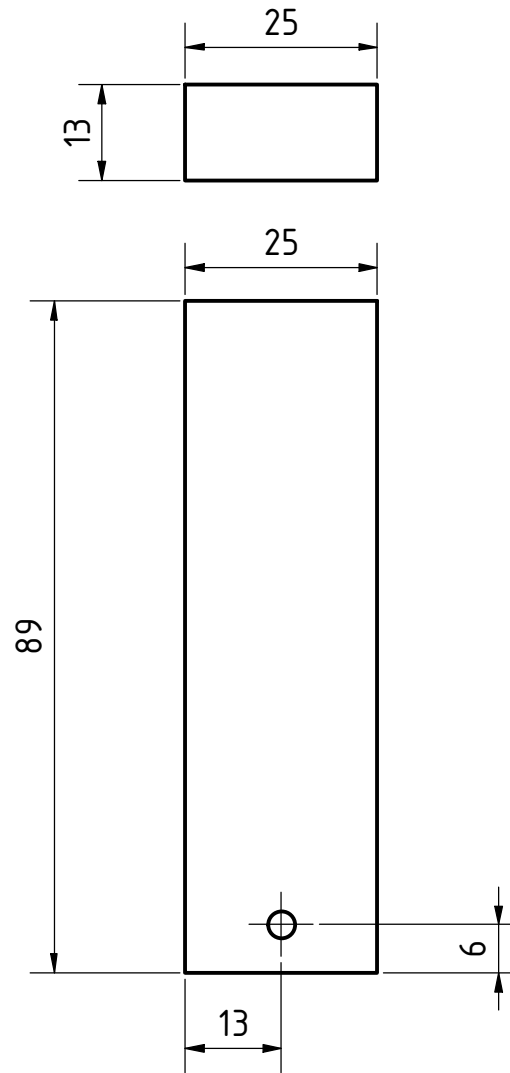

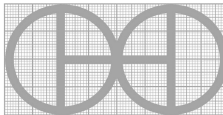
PROJEKT		ERSTELLT VON	GENEHMIGT VON	DATE	VERSION
Reagenzglas-Stand		E. CEBALLOS	A. MORILLO	15-05-2021	1.0
TEIL-NAME		DATEI-NAME			TEIL-CODE
Vertikale_Halterung_1		Vertical_support_1.ipt			2
ENTWICKELT VON	UMGESTALTET VON	UNTERSTUETZT DURCH	DOK. TYP	WERKSTOFF	MENGE
			PART	Holz	1
AMERICAN PEACE CORPS OHO e.V.			LIZENZ	SCALE	SEITE
			CC-BY-SA 4.0	2:1	5 / 9

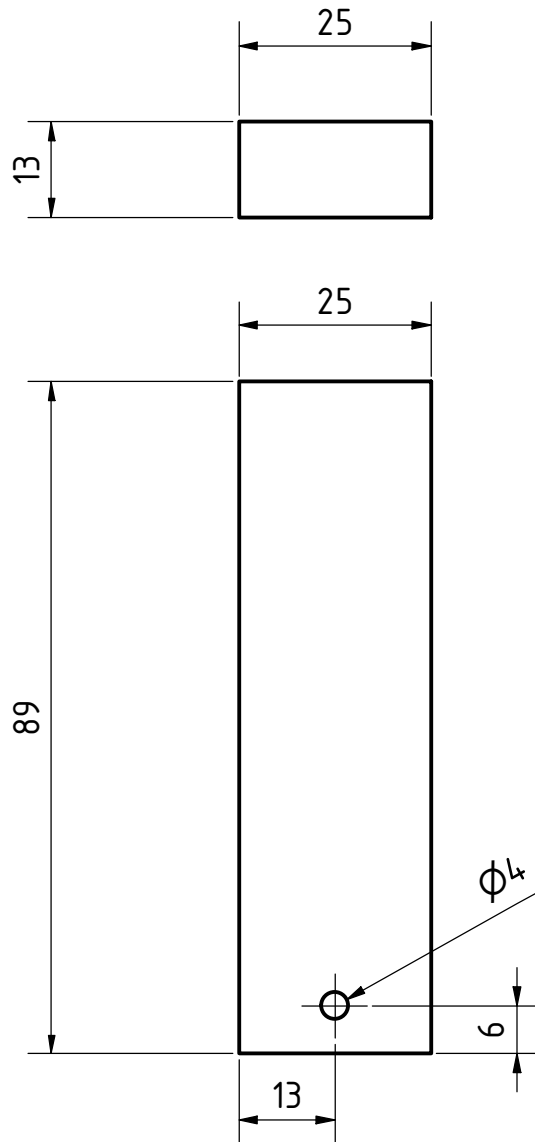

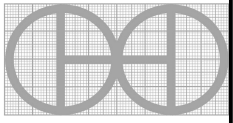
PROJEKT		ERSTELLT VON	GENEHMIGT VON	DATE	VERSION
Reagenzglas-Stand		E. CEBALLOS	A. MORILLO	15-05-2021	1.0
TEIL-NAME		DATEI-NAME			TEIL-CODE
Vertikale_Halterung_2		Vertical_support_2.ipt			3
ENTWICKELT VON	UMGESTALTET VON	UNTERSTUETZT DURCH	DOK. TYP	WERKSTOFF	MENGE
				Holz	1
AMERICAN PEACE CORPS		OHO e.V.	CC-BY-SA 4.0	SCALE	SEITE
				1:1	6 / 9

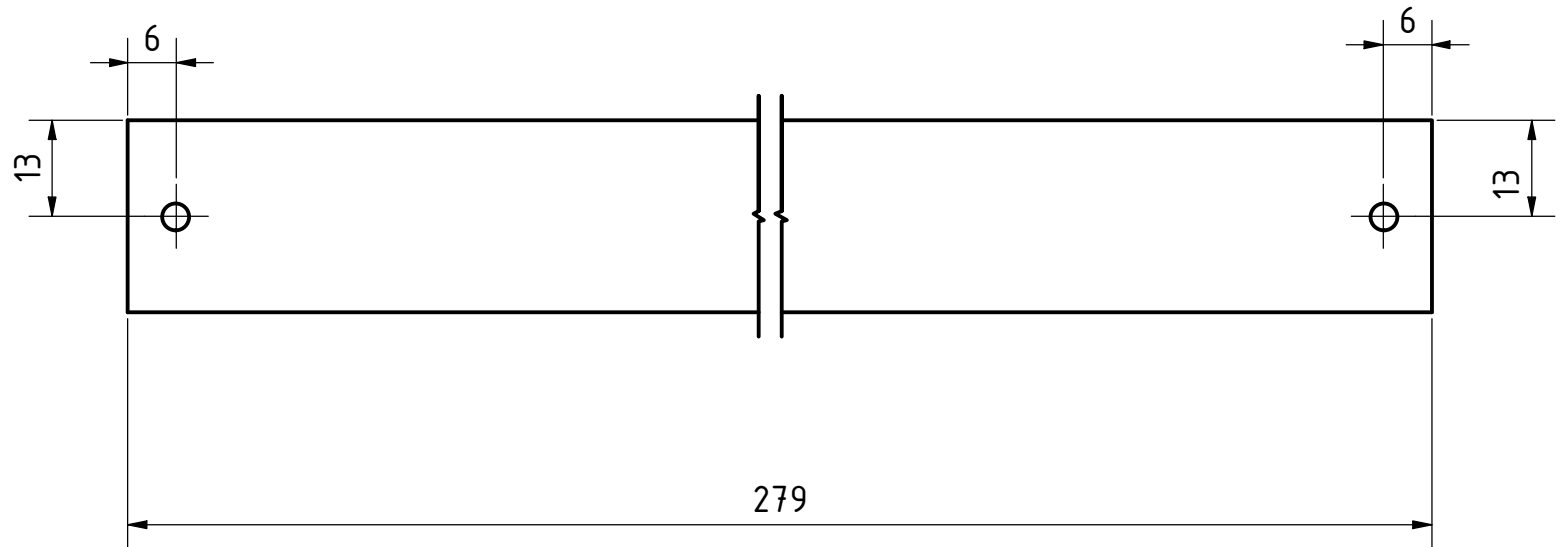
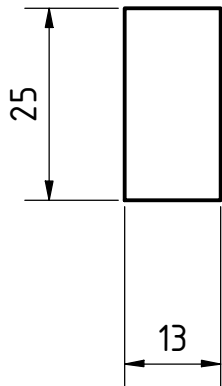

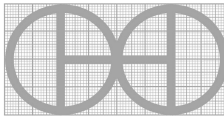
PROJEKT		ERSTELLT VON		GENEHMIGT VON		DATE		VERSION	
Reagenzglas-Stand		E. CEBALLOS		A. MORILLO		15-05-2021		1.0	
TEIL-NAME				DATEI-NAME				TEIL-CODE	
Oberer Teil				Upper_part.ipt				4	
ENTWICKELT VON		UMGESTALTET VON		UNTERSTUETZT DURCH		DOK. TYP	WERKSTOFF		MENGE
							Holz		1
						LIZENZ		SCALE	SEITE
AMERICAN PEACE CORPS		OHO e.V.				CC-BY-SA 4.0		1:1	7 / 9

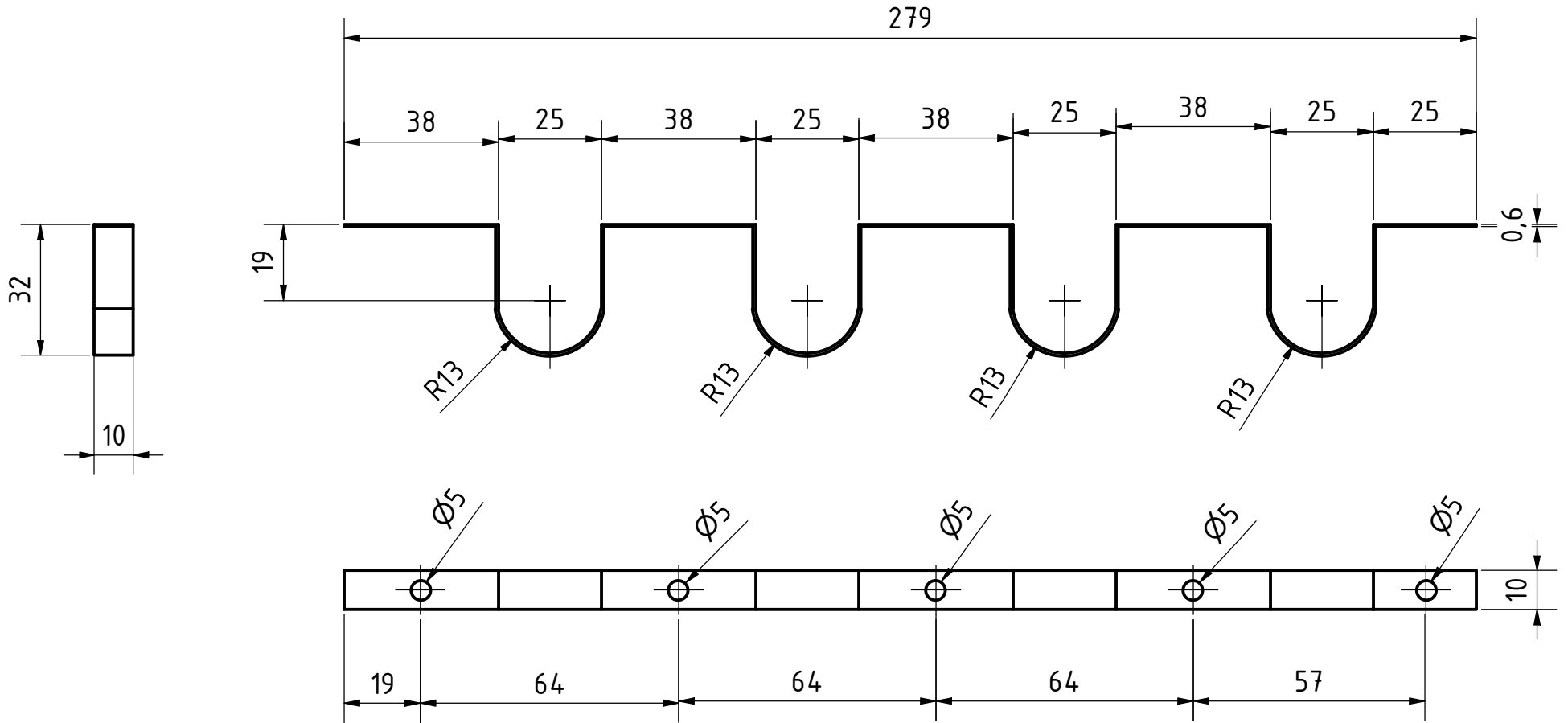

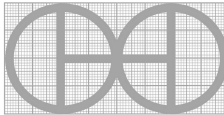
PROJEKT		ERSTELLT VON		GENEHMIGT VON		DATE		VERSION	
Reagenzglas-Stand		E. CEBALLOS		A. MORILLO		15-05-2021		1.0	
TEIL-NAME				DATEI-NAME				TEIL-CODE	
Band_1				Band_1.ipt				5	
ENTWICKELT VON		UMGESTALTET VON		UNTERSTUETZT DURCH		DOK. TYP	WERKSTOFF		MENGE
							Rostfreier Stahl		1
AMERICAN PEACE CORPS		OHO e.V.				LIZENZ		SCALE	SEITE
						CC-BY-SA 4.0		1:1.5	8 / 9

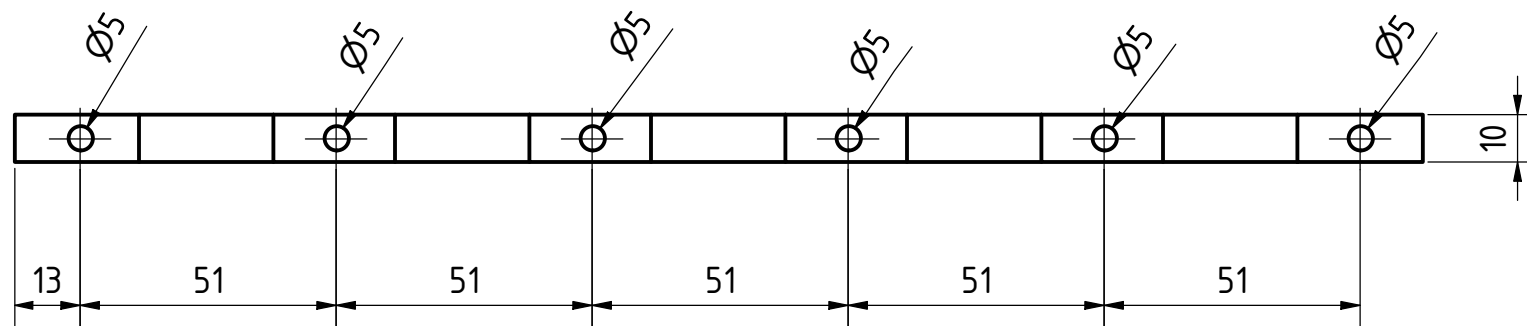
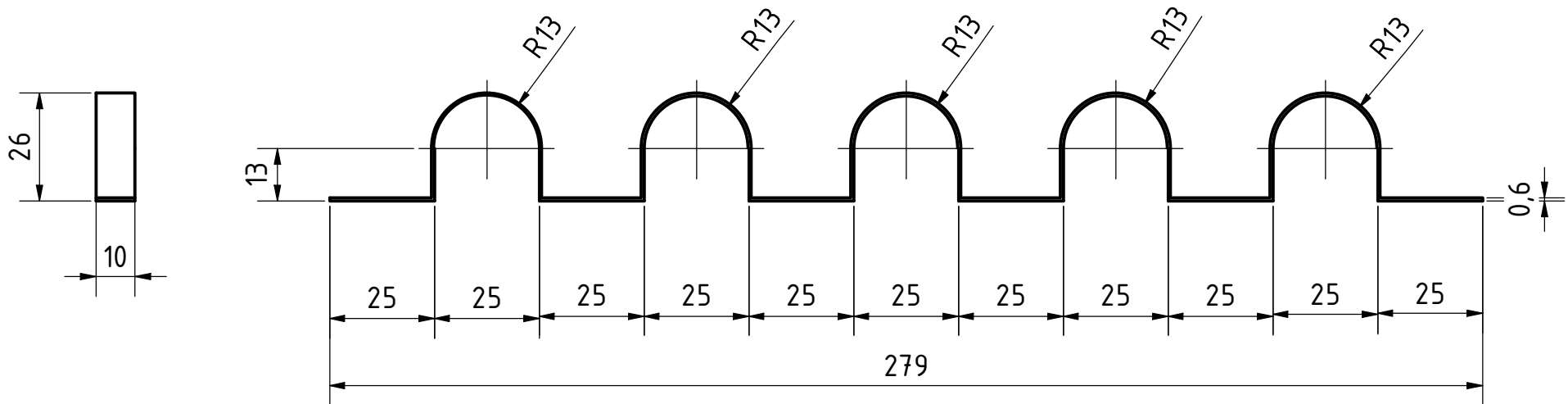

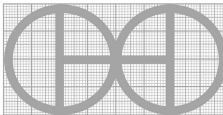
PROJEKT		ERSTELLT VON		GENEHMIGT VON		DATE		VERSION	
Reagenzglas-Stand		E. CEBALLOS		A. MORILLO		15-05-2021		1.0	
TEIL-NAME				DATEI-NAME				TEIL-CODE	
Band_2				Band_2.ipt				6	
ENTWICKELT VON		UMGESTALTET VON		UNTERSTUETZT DURCH		DOK. TYP	WERKSTOFF		MENGE
							Rostfreier Stahl		1
AMERICAN PEACE CORPS				OHO e.V.		LIZENZ		SCALE	SEITE
						CC-BY-SA 4.0		1:1.5	9 / 9