







PROJECT LONG ANDRE CARGO BIKE A		CREATED BY A. PARDO		APPROVED BY D. Jaeger	
PART NAME Long AndrCargo Bike A		PART CODE A1		DOCUMENT TYPE	
 		LICENSE CC-BY-SA 4.0		MATERIAL	
		FILE NAME Long AndrCargo Bike A.iam		VERSION 1.0	
		SCALE 1 / 15		QUANTITY	
		SHEET 1		DATE 31/12/2020	



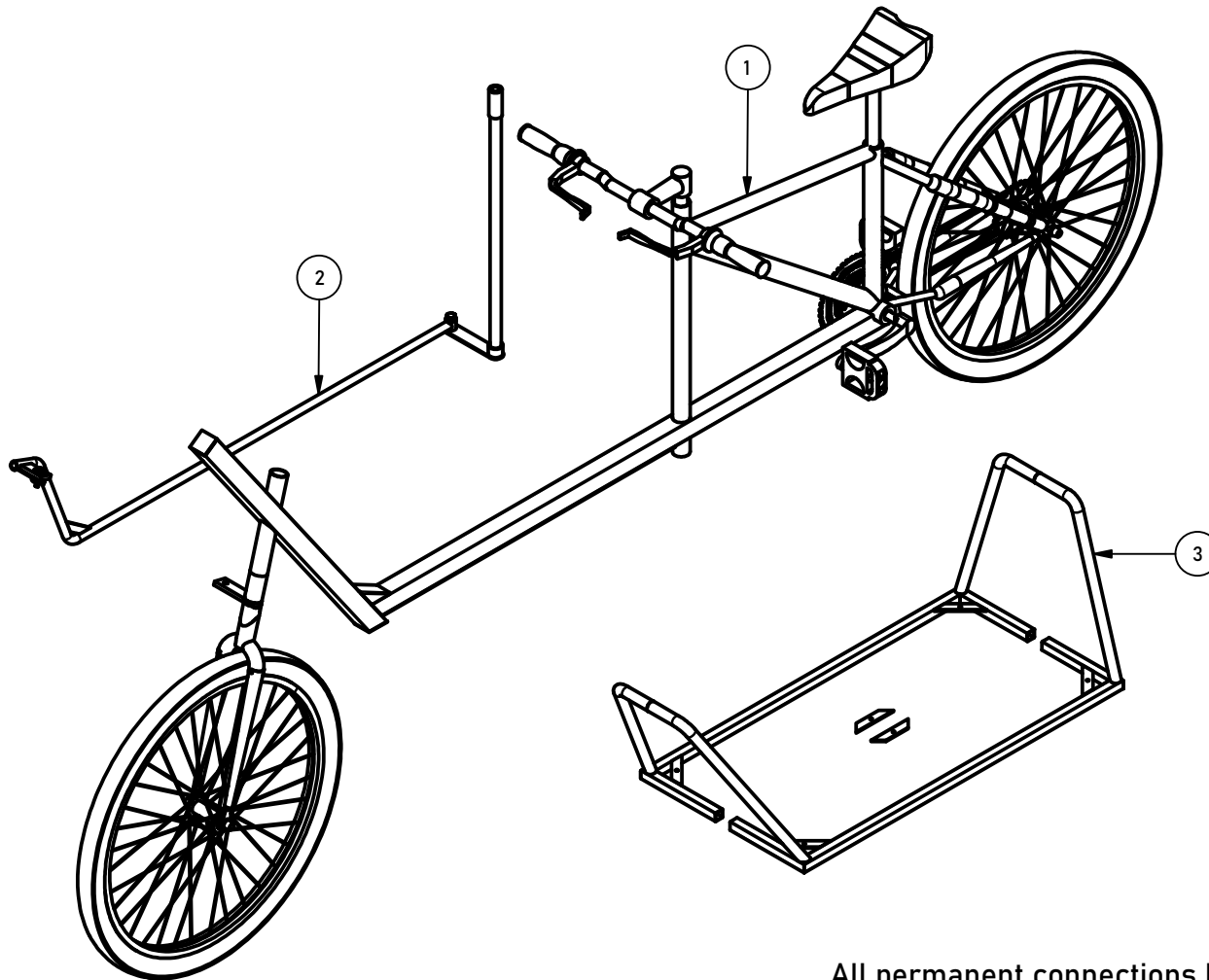

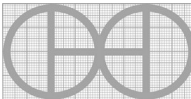
All permanent connections between parts are welded, bolted connections are indicated on the drawings.

PROJECT LONG ANDRE CARGO BIKE A	CREATED BY A. PARDO	APPROVED BY D. Jaeger		
PART NAME Long AndrCargo Bike A	PART CODE A2	DOCUMENT TYPE	MATERIAL	
 	LICENSE CC-BY-SA 4.0	FILE NAME Long AndrCargo Bike A.iam	VERSION 1.0	QUANTITY
		SCALE 1 / 14	SHEET 2	DATE 31/12/2020

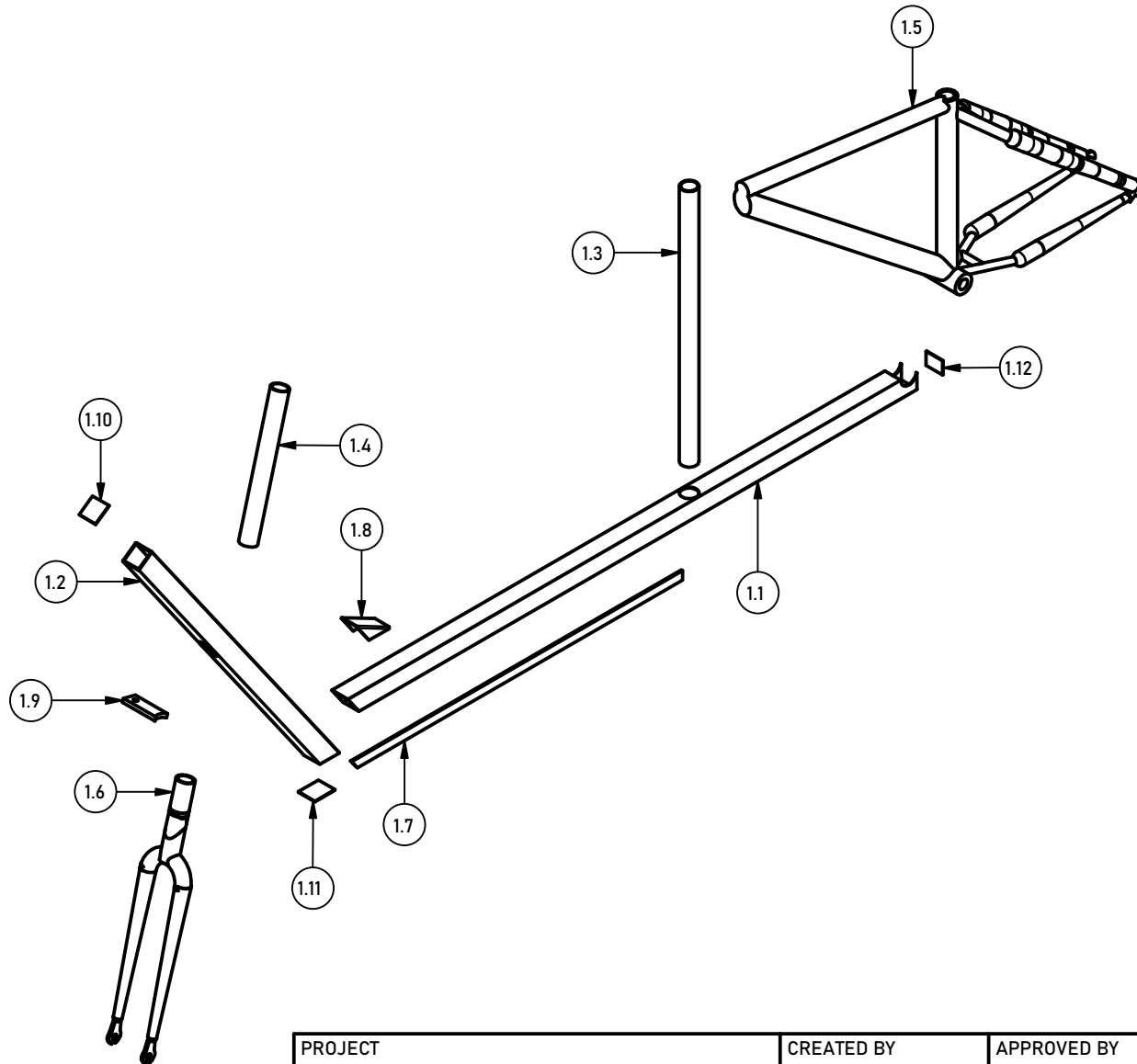

PARTS LIST							
POS.	POS. OLD	QTY	PART NAME	FILE NAME	PART TYPE	SPECIFICATION	SHEET
A1		1	LONG ANDRE CARGO BIKE A	Long AndrCargo Bike A.iam			1
A2		1	LONG ANDRE CARGO BIKE A	Long AndrCargo Bike A.iam			2
B1		1	PARTS LIST	part-list-Long AndrCargo Bike A.iam			3
1		1	Assembly1-Long AndrCargo Bike	Assembly1-Long AndrCargo Bike A.iam			4
1.1	1	1	wl_lacb_1.1_Down-tube	wl_lacb_1.1_Down-tube.ipt	Production	A36	5
1.2	4	1	wl_lacb_1.2_Down-tube-bend	wl_lacb_1.2_Down-tube-bend.ipt	Production	A36	6
1.3	2	1	wl_lacb_1.3_Long-head-tube	wl_lacb_1.3_Long-head-tube.ipt	Production	A36	7
1.4	5	1	wl_lacb_1.4_short-head-tube	wl_lacb_1.4_short-head-tube.ipt	Production	A36	8
1.5	3	1	wl_lacb_1.5_Frame	wl_lacb_1.5_Frame.ipt	Standard	26 inch size	
1.6	8	1	wl_lacb_1.6_Fork-20	wl_lacb_1.6_Fork-20.ipt	Standard		
1.7	7	1	wl_lacb_1.7_Joist	wl_lacb_1.7_Joist.ipt	Production	A36	9
1.8	6	1	wl_lacb_1.8_Stiffening-angle	wl_lacb_1.8_Stiffening-angle.ipt	Production	A36	10
1.9	16	1	wl_lacb_1.9_Short-steering-lever	wl_lacb_1.9_Short-steering-lever.ipt	Production	A36	11
1.10	20	1	wl_lacb_1.10_Cover-plates	wl_lacb_1.10_Cover-plates.ipt	Production	A36	12
1.11	20	1	wl_lacb_1.11_Cover-plates	wl_lacb_1.11_Cover-plates.ipt	Production	A36	13
1.12	20	1	wl_lacb_1.12_Cover-plates	wl_lacb_1.12_Cover-plates.ipt	Production	A36	14
2		1	Assembly2-Long AndrCargo Bike A	Assembly2-Long AndrCargo Bike A.iam			15
2.1	11	1	wl_lacb_2.1_Bearing-seat-cone	wl_lacb_2.1_Bearing-seat-cone.ipt	Standard		
2.2	12	1	wl_lacb_2.2_Long-steering-lever	wl_lacb_2.2_Long-steering-lever.ipt	Production	A36	16
2.3	13	1	wl_lacb_2.3_Handlebar	wl_lacb_2.3_Handlebar.ipt	Production	A36	17
2.4	14	1	wl_lacb_2.4_Sintered-bearing-housing	wl_lacb_2.4_Sintered-bearing-housing.ipt	Production	A36	18
2.5	15	1	wl_lacb_2.5_Angle-handlebar	wl_lacb_2.5_Angle-handlebar.ipt	Production	A36	19
2.6		1	wl_lacb_2.6_Short-steering-lever	wl_lacb_2.6_Short-steering-lever.ipt	Production	A36	20
2.7	10	1	wl_lacb_2.7_Shaft-extension	wl_lacb_2.7_Shaft-extension.ipt	Production	A36	21
2.8	15	1	wl_lacb_2.8_Angle-handlebar	wl_lacb_2.8_Angle-handlebar.ipt	Production	A36	22
2.9	9	1	wl_lacb_2.9_Steer-tube-1	wl_lacb_2.9_Steer-tube-1.ipt	Standard		
2.10		1	Inner Ring	ANSI_AFBMA 18.1 NR - 10x15x18 - 2_21.ipt	Standard	ANSI_AFBMA 18.1 NR - 10x15x18 - 2_21.ipt	
2.11		1	Hex Jam Nut	ANSI B18.2.4.5M - M10 x 1.5 - 16.ipt	Standard	ANSI B18.2.4.5M - M10 x 1.5 - 16.ipt	
2.12		2	Metric Plain Washers	ANSI B18.22M - 10 N.ipt	Standard	ANSI B18.22M - 10 N.ipt	
2.13		1	Metric Formed Hex Screw - Formed Hex Screw	ANSI B18.2.3.2M - M10x1,5 x 35.ipt	Standard	ANSI B18.2.3.2M - M10x1,5 x 35.ipt	
2.14		1	Broached Hexagon Socket Head Shoulder Screw	ANSI B18.3.3M - M6x1 x 31,25.ipt	Standard	ANSI B18.3.3M - M6x1 x 31,25.ipt	
2.15		1	Hex Jam Nut	ANSI B18.2.4.5M - M6 x 1.ipt	Standard	ANSI B18.2.4.5M - M6 x 1.ipt	
2.16		2	Metric Plain Washers	ANSI B18.22M - 8 R.ipt	Standard	ANSI B18.22M - 8 R.ipt	
3		1	Assembly3-Long AndrCargo Bike A	Assembly3-Long AndrCargo Bike A.iam			23
3.1	17	1	wl_lacb_3.1_Frame-loading-area	wl_lacb_3.1_Frame-loading-area.ipt	Production	A36	24
3.2	17	1	wl_lacb_3.2_Frame-loading-area	wl_lacb_3.2_Frame-loading-area.ipt	Production	A36	25
3.3	19	1	wl_lacb_3.3_Mounting-bracket	wl_lacb_3.3_Mounting-bracket.ipt	Production	A36	26
3.4	18	1	wl_lacb_3.4_Bracket-loading-area	wl_lacb_3.4_Bracket-loading-area.ipt	Production	A36	27
3.5	18	1	wl_lacb_3.5_Bracket-loading-area	wl_lacb_3.5_Bracket-loading-area.ipt	Production	A36	28

PROJECT LONG ANDRE CARGO BIKE A		CREATED BY A. PARDO	APPROVED BY D. Jaeger		
PART NAME Long AndrCargo Bike A		PART CODE B1	DOCUMENT TYPE	MATERIAL	
 		LICENSE CC-BY-SA 4.0	FILE NAME part-list-Long AndrCargo Bike A.iam	VERSION 1.0	QUANTITY
			SCALE 1 / 100	SHEET 3	DATE 30/12/2020

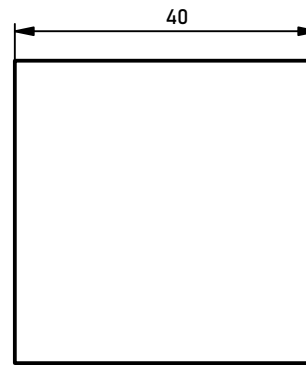
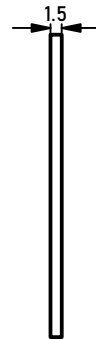
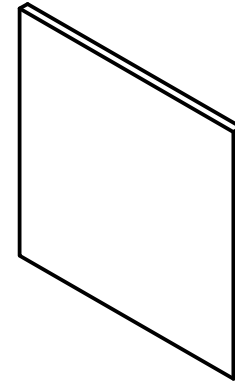

PROJECT LONG ANDRE CARGO BIKE A		CREATED BY A. PARDO		APPROVED BY D. Jaeger	
PART NAME Assembly1-Long André Cargo Bike		PART CODE 1		DOCUMENT TYPE	
 		LICENSE CC-BY-SA 4.0		FILE NAME Assembly1-Long AndréCargoBike.iam	
		SCALE 1 : 12		VERSION 1.0	
		SHEET 4		QUANTITY	
		DATE 28/12/2020			



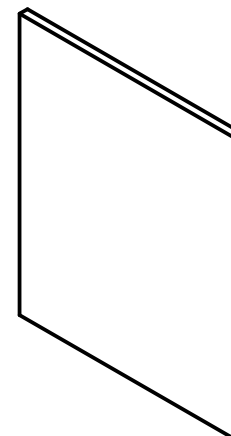
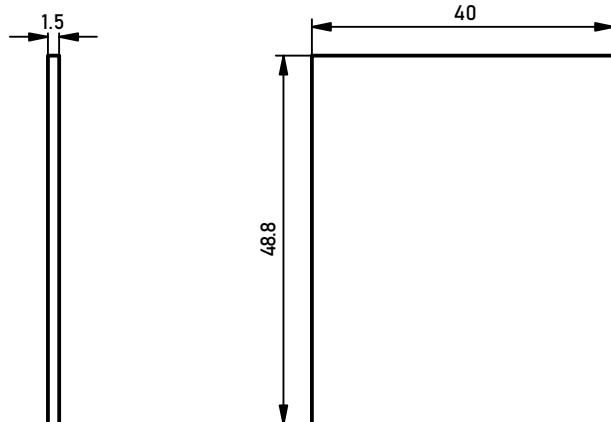

PROJECT LONG ANDRE CARGO BIKE A		CREATED BY A. PARDO	APPROVED BY D. Jaeger		
PART NAME wL_lacb_1.10_Cover-plates		PART CODE 1.10	DOCUMENT TYPE Production	MATERIAL A36	
 	LICENSE CC-BY-SA 4.0	FILE NAME wL_lacb_1.10_Cover-plates.ipt	VERSION 1.0	QUANTITY 1	
		SCALE 1:1	SHEET 12	DATE 30/12/2020	

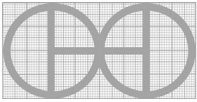

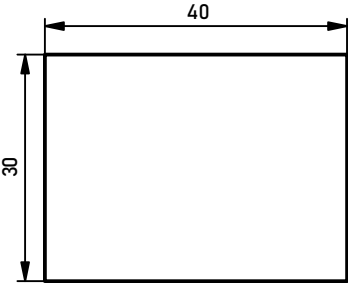
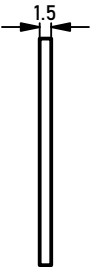
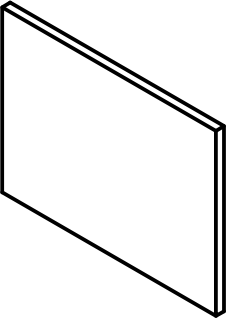

PROJECT LONG ANDRE CARGO BIKE A		CREATED BY A. PARDO		APPROVED BY D. Jaeger	
PART NAME wL_lacb_1.11_Cover-plates		PART CODE 1.11		DOCUMENT TYPE Production	
 		LICENSE CC-BY-SA 4.0		FILE NAME wL_lacb_1.11_Cover-plates.ipt	
		SCALE 1:1		MATERIAL A36	
		VERSION 1.0		QUANTITY 1	
		SHEET 13		DATE 30/12/2020	



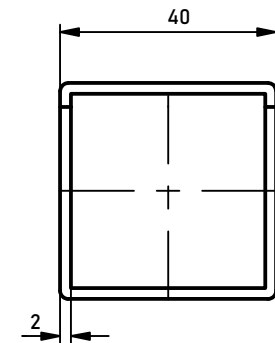
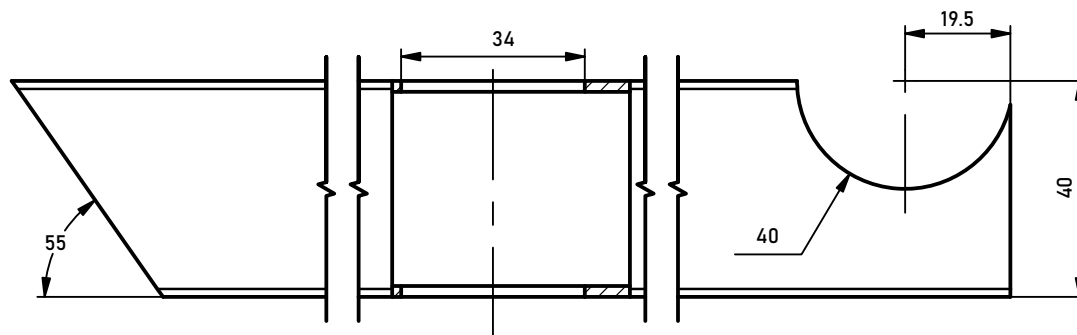
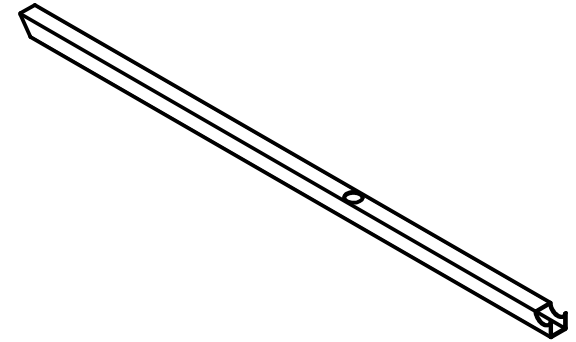
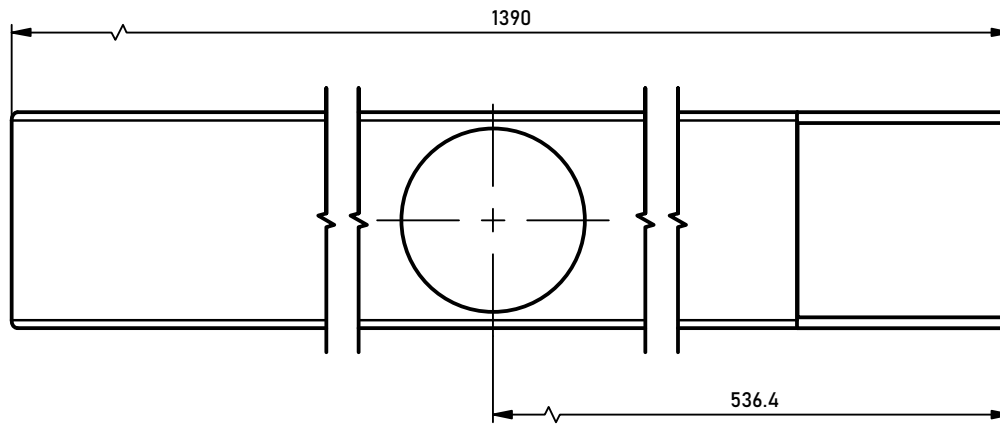

PROJECT LONG ANDRE CARGO BIKE A		CREATED BY A. PARDO		APPROVED BY D. Jaeger	
PART NAME wL_lacb_1.12_Cover-plates		PART CODE 1.12		DOCUMENT TYPE Production	
 		LICENSE CC-BY-SA 4.0		MATERIAL A36	
		FILE NAME wL_lacb_1.12_Cover-plates.ipt		VERSION 1.0	QUANTITY 1
		SCALE 1:1		SHEET 14	DATE 30/12/2020



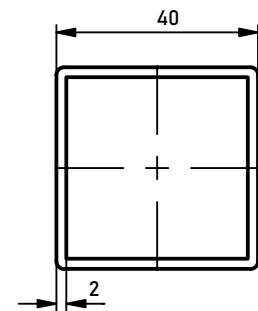
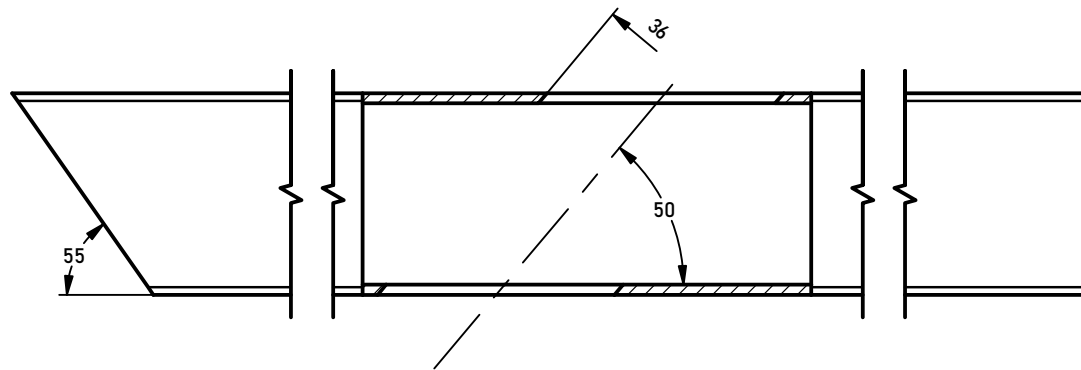
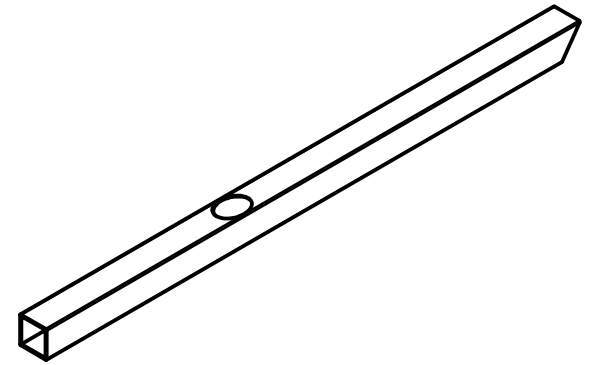
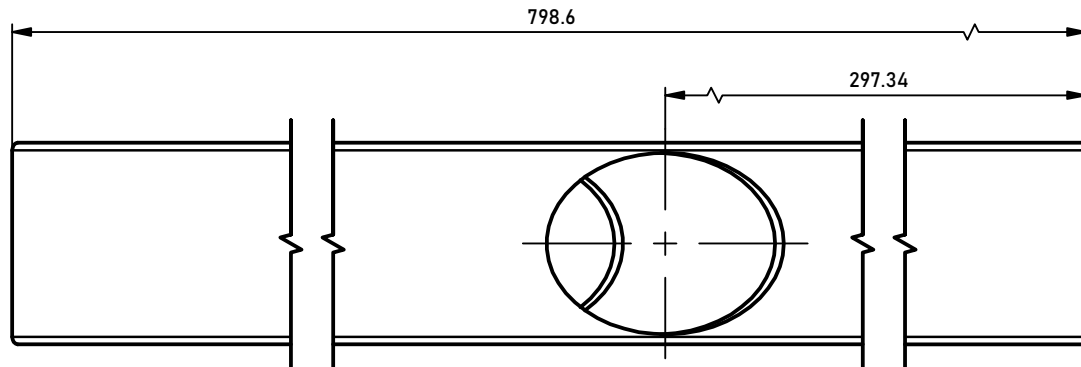

PROJECT LONG ANDRE CARGO BIKE A	CREATED BY A. PARDO	APPROVED BY D. Jaeger		
PART NAME wL_lacb_1.1_Down-tube	PART CODE 1.1	DOCUMENT TYPE Production	MATERIAL A36	
 	LICENSE CC-BY-SA 4.0	FILE NAME wL_lacb_1.1_Down-tube.ipt	VERSION 1.0	QUANTITY 1
		SCALE 1:1.4	SHEET 5	DATE 28/12/2020



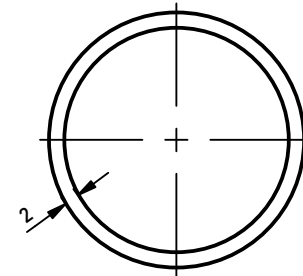
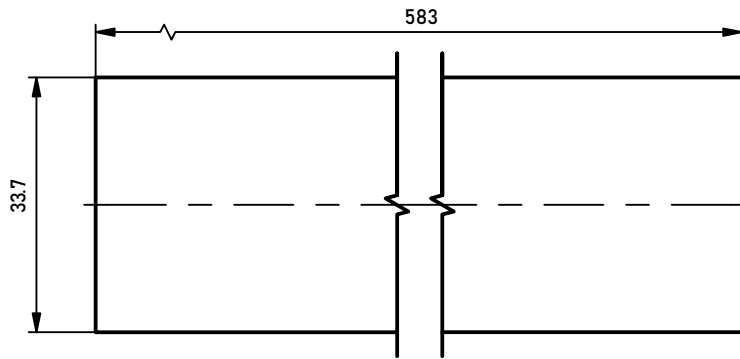
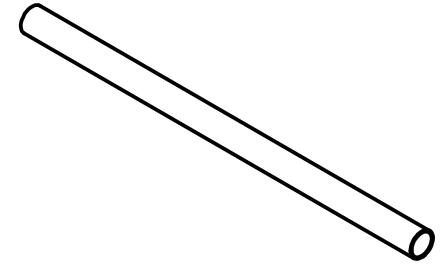

PROJECT LONG ANDRE CARGO BIKE A	CREATED BY A. PARDO	APPROVED BY D. Jaeger		
PART NAME wL_lacb_1.2_Down-tube-bend	PART CODE 1.2	DOCUMENT TYPE Production	MATERIAL A36	
 	LICENSE CC-BY-SA 4.0	FILE NAME wL_lacb_1.2_Down-tube-bend.ipt	VERSION 1.0	QUANTITY 1
		SCALE 1:1.5	SHEET 6	DATE 28/12/2020

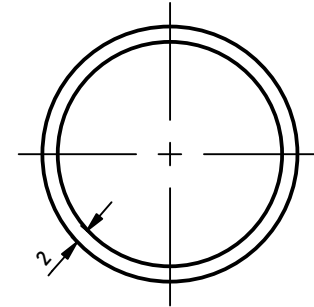
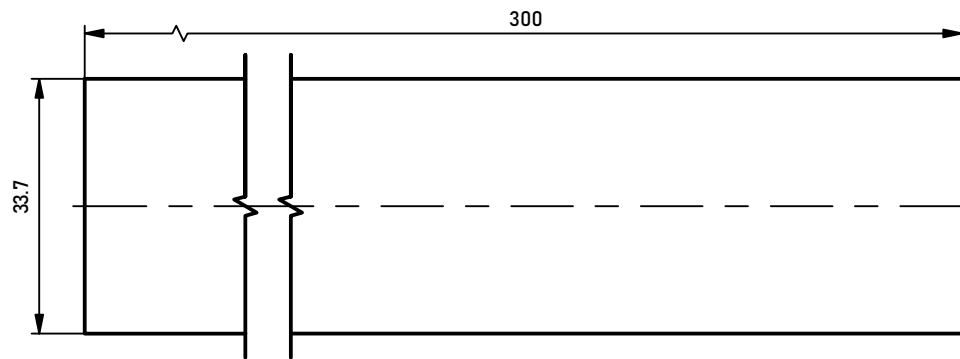
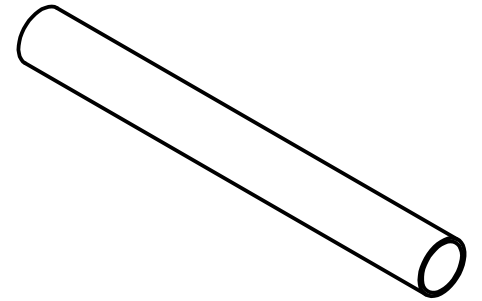

PROJECT LONG ANDRE CARGO BIKE A		CREATED BY A. PARDO		APPROVED BY D. Jaeger	
PART NAME wL_lacb_1.3_Long-head-tube		PART CODE 1.3		DOCUMENT TYPE Production	
 		LICENSE CC-BY-SA 4.0		FILE NAME wL_lacb_1.3_Long-head-tube.ipt	
				SCALE 1:1	
				VERSION 1.0	
				QUANTITY 1	
				SHEET 7	
				DATE 28/12/2020	



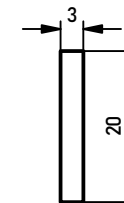
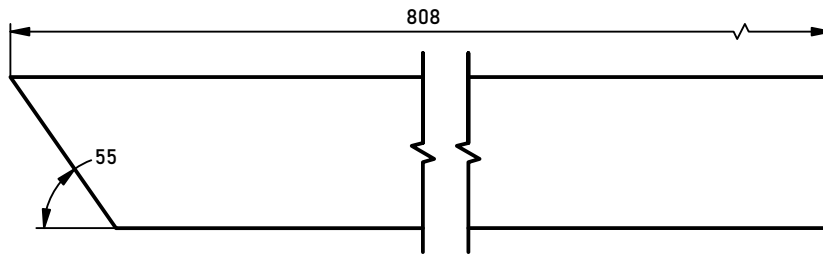
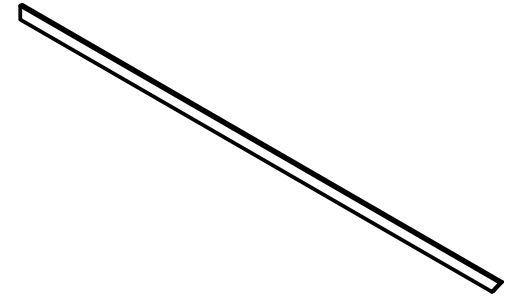

PROJECT LONG ANDRE CARGO BIKE A		CREATED BY A. PARDO		APPROVED BY D. Jaeger	
PART NAME wl_lacb_1.4_short-head-tube		PART CODE 1.4		DOCUMENT TYPE Production	
 		LICENSE CC-BY-SA 4.0		FILE NAME wl_lacb_1.4_short-head-tube.ipt	
		SCALE 1:1		MATERIAL A36	
		VERSION 1.0		QUANTITY 1	
		SHEET 8		DATE 28/12/2020	

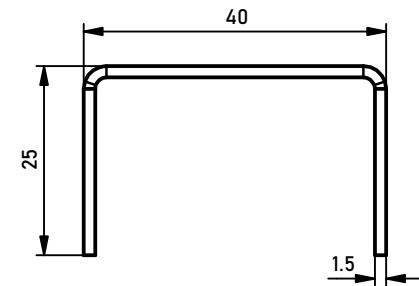
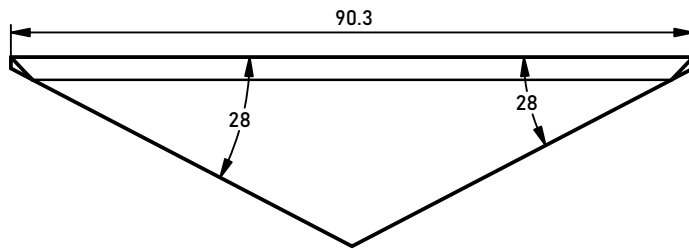
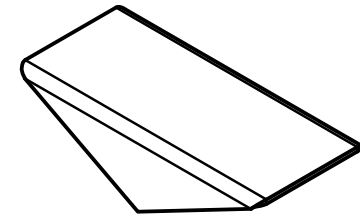
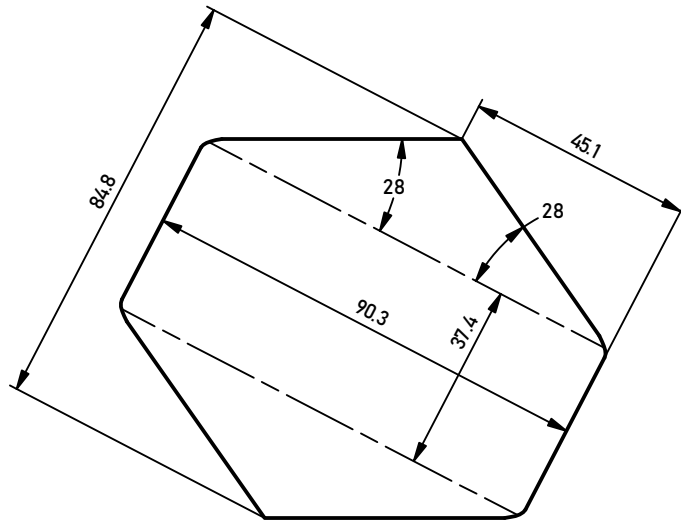

PROJECT LONG ANDRE CARGO BIKE A		CREATED BY A. PARDO		APPROVED BY D. Jaeger	
PART NAME wL_lacb_1.7_Joist		PART CODE 1.7		DOCUMENT TYPE Production	
		LICENSE CC-BY-SA 4.0		MATERIAL A36	
		FILE NAME wL_lacb_1.7_Joist.ipt		VERSION 1.0	QUANTITY 1
		SCALE 1:1		SHEET 9	DATE 28/12/2020



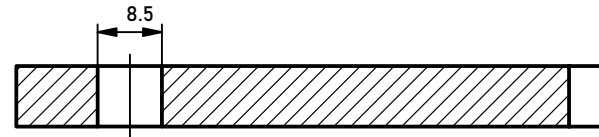
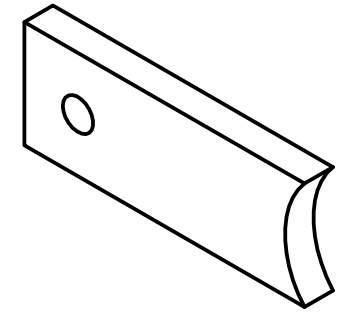

PROJECT LONG ANDRE CARGO BIKE A		CREATED BY A. PARDO		APPROVED BY D. Jaeger	
PART NAME wL_lacb_1.8_Stiffening-angle		PART CODE 1.8		DOCUMENT TYPE Production	
 		LICENSE CC-BY-SA 4.0		FILE NAME wL_lacb_1.8_Stiffening-angle.ipt	
				SCALE 1 : 1.5	
				MATERIAL A36	
				VERSION 1.0	
				QUANTITY 1	
				SHEET 10	
				DATE 28/12/2020	



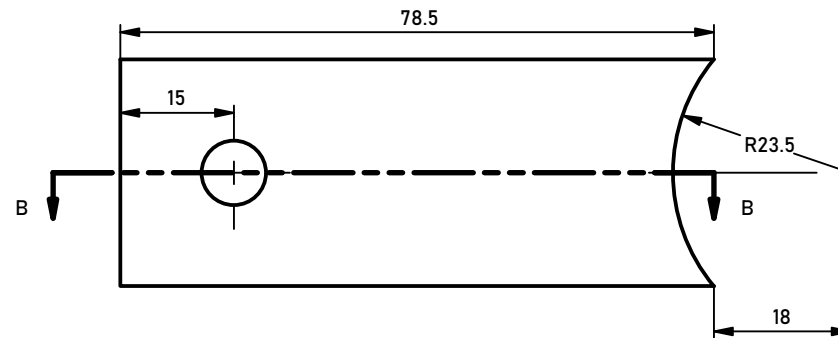
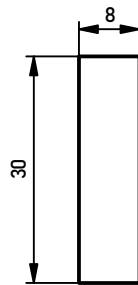

SECTION B-B
SCALE 1:1



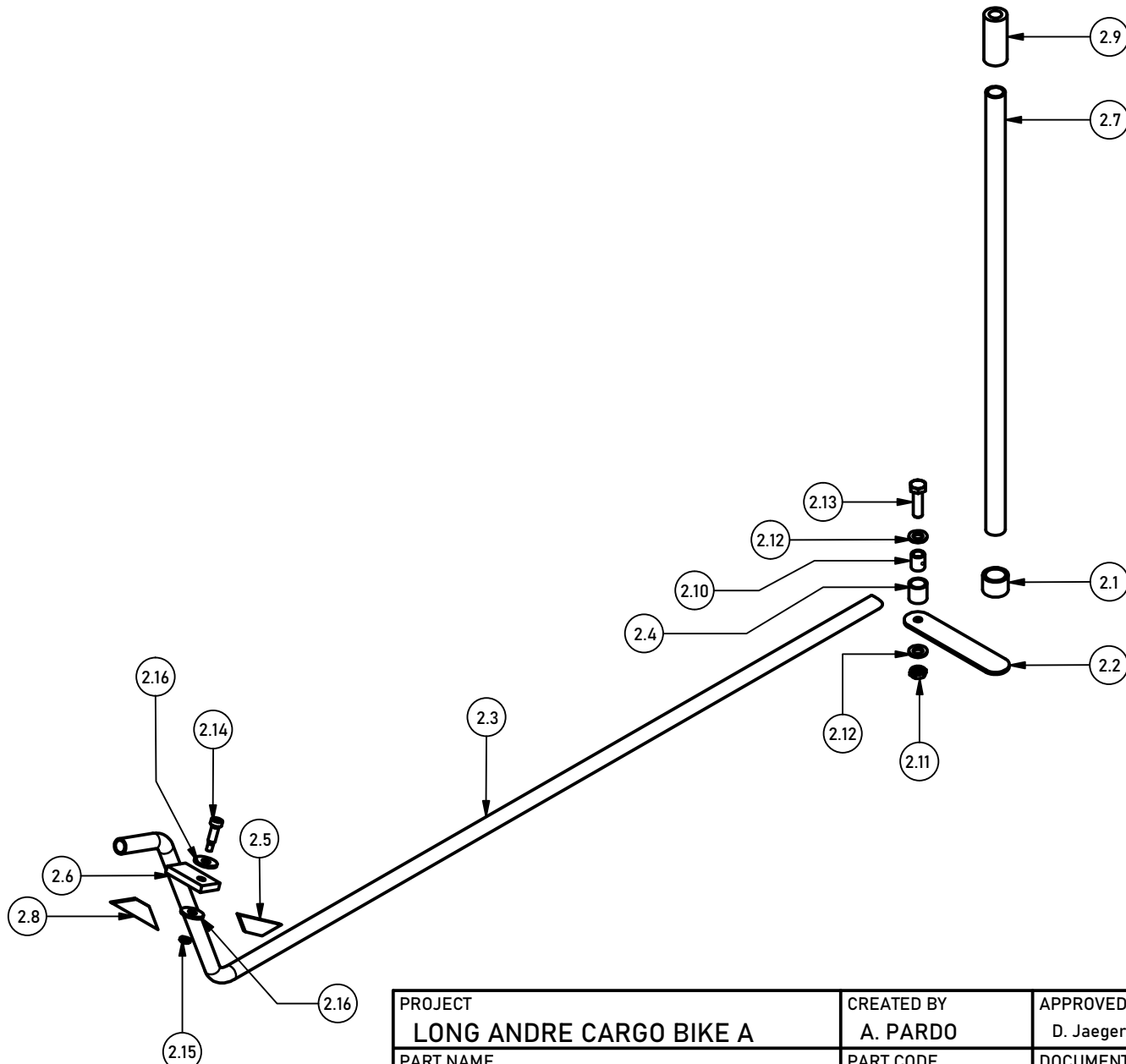

PROJECT LONG ANDRE CARGO BIKE A		CREATED BY A. PARDO		APPROVED BY D. Jaeger	
PART NAME wL_lacb_1.9_Short-steering-leve		PART CODE 1.9		DOCUMENT TYPE Production	
 		LICENSE CC-BY-SA 4.0		MATERIAL A36	
		FILE NAME wL_lacb_1.9_Short-steering-lever		VERSION ipt1.0	
		SCALE 1:1		SHEET 11	
				QUANTITY 1	
				DATE 28/12/2020	



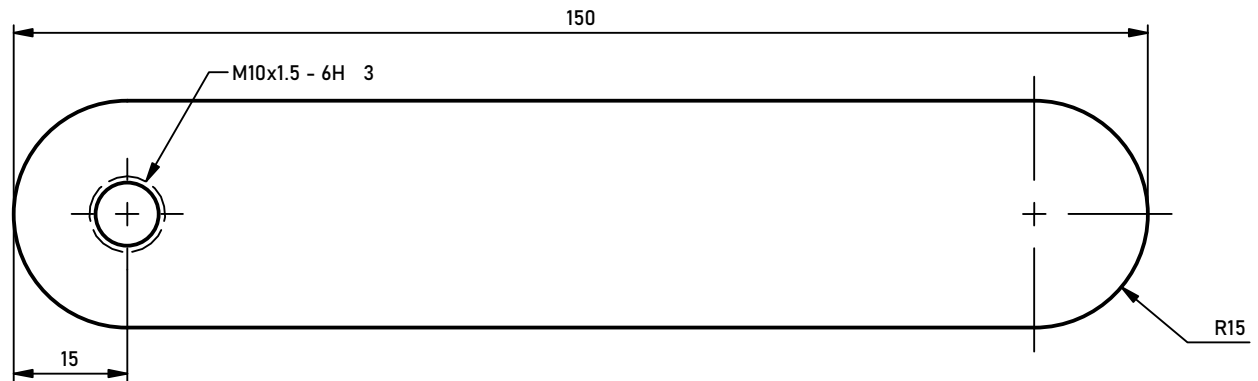
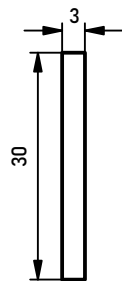
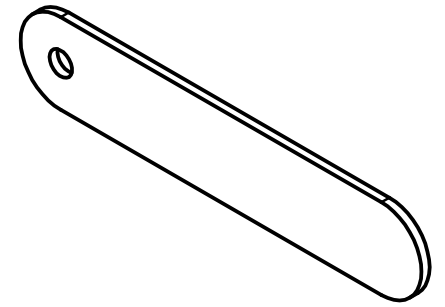

PROJECT LONG ANDRE CARGO BIKE A		CREATED BY A. PARDO		APPROVED BY D. Jaeger	
PART NAME Assembly2-Long André Cargo Bike		PART CODE 2		DOCUMENT TYPE	
 		LICENSE CC-BY-SA 4.0		FILE NAME Assembly2-Long AndréCargoBike.iam	
		VERSION 1.0		QUANTITY	
		SCALE 1 : 7		SHEET 15	
				DATE 29/12/2020	



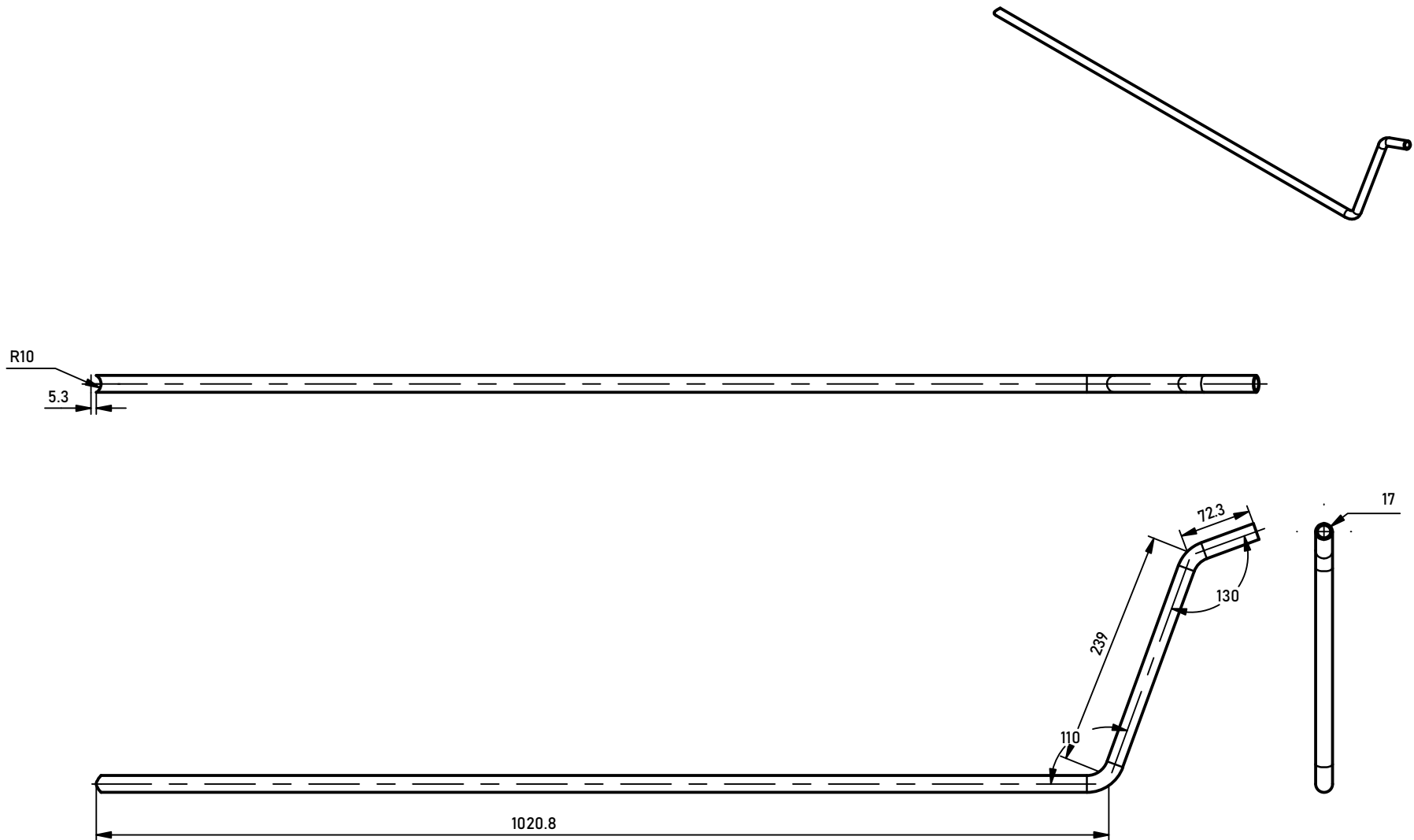

PROJECT LONG ANDRE CARGO BIKE A		CREATED BY A. PARDO		APPROVED BY D. Jaeger	
PART NAME wl_lacb_2.2_Long-steering-lever		PART CODE 2.2		DOCUMENT TYPE Production	
 		LICENSE CC-BY-SA 4.0		MATERIAL A36	
		FILE NAME wl_lacb_2.2_Long-steering-lever		VERSION pt1.0	
		SCALE 1:1		SHEET 16	
				DATE 28/12/2020	

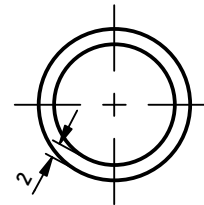
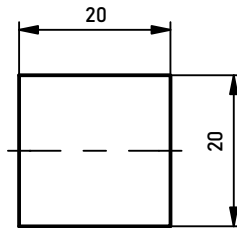
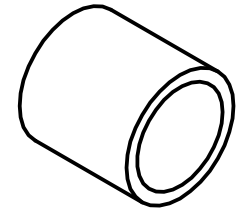

PROJECT LONG ANDRE CARGO BIKE A		CREATED BY A. PARDO		APPROVED BY D. Jaeger	
PART NAME wL_lacb_2.3_Handlebar		PART CODE 2.3		DOCUMENT TYPE Production	
 		LICENSE CC-BY-SA 4.0		FILE NAME wL_lacb_2.3_Handlebar.ipt	
		SCALE 1:6		MATERIAL A36	
		VERSION 1.0		QUANTITY 1	
		SHEET 17		DATE 29/12/2020	



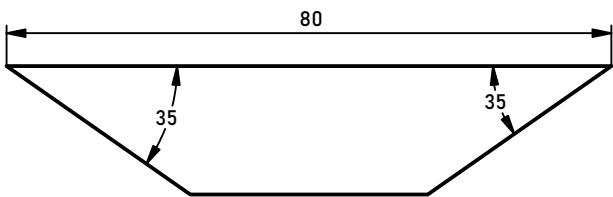
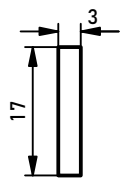
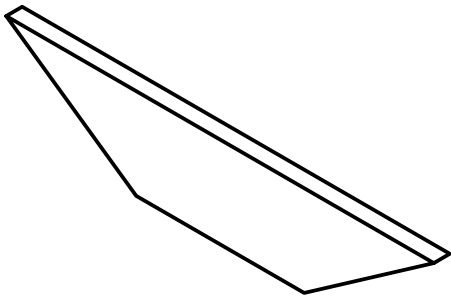

PROJECT LONG ANDRE CARGO BIKE A		CREATED BY A. PARDO		APPROVED BY D. Jaeger	
PART NAME wl_lacb_2.4_Sintered-bearing-housing		PART CODE 2.4		DOCUMENT TYPE Production	
 		LICENSE CC-BY-SA 4.0		MATERIAL A36	
		FILE NAME wl_lacb_2.4_Sintered-bearing-housing.ipt		VERSION 1	
		SCALE 1:1		SHEET 18	
				DATE 28/12/2020	

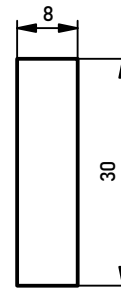
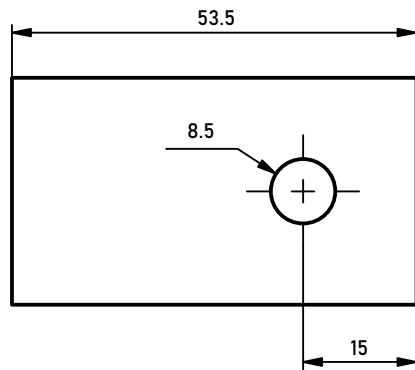
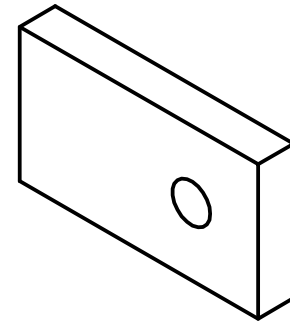

PROJECT LONG ANDRE CARGO BIKE A		CREATED BY A. PARDO		APPROVED BY D. Jaeger	
PART NAME wL_lacb_2.5_Angle-handlebar		PART CODE 2.5		DOCUMENT TYPE Production	
		LICENSE CC-BY-SA 4.0		MATERIAL A36	
		FILE NAME wL_lacb_2.5_Angle-handlebar.ipt		VERSION 1.0	QUANTITY 1
		SCALE 1:1		SHEET 19	DATE 29/12/2020



PROJECT LONG ANDRE CARGO BIKE A		CREATED BY A. PARDO		APPROVED BY D. Jaeger	
PART NAME wl_lacb_2.6_Short-steering-lever		PART CODE 2.6		DOCUMENT TYPE Production	
 		LICENSE CC-BY-SA 4.0		MATERIAL A36	
		FILE NAME wl_lacb_2.6_Short-steering-lever		VERSION ipfl.0	QUANTITY 1
		SCALE 1:1		SHEET 20	DATE 28/12/2020

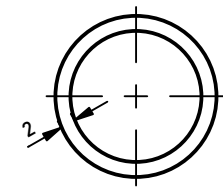
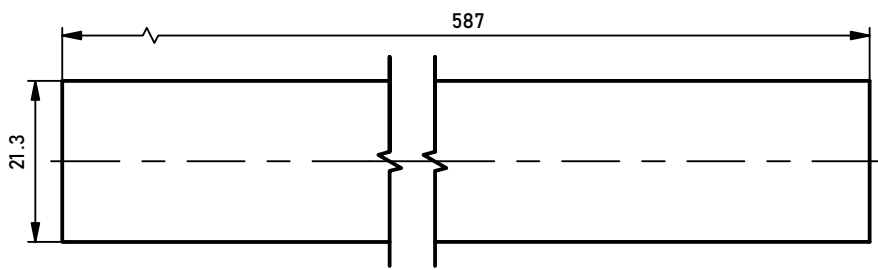
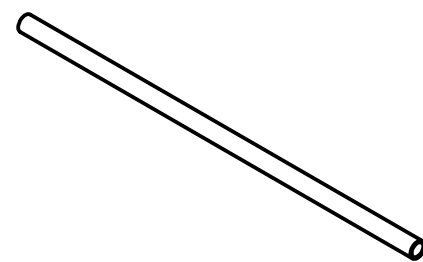

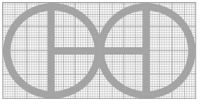

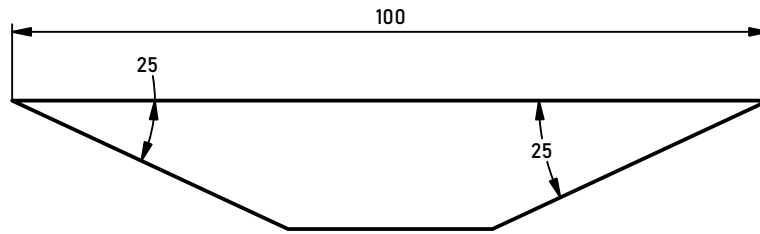
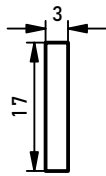
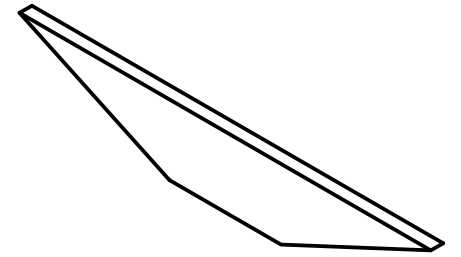
PROJECT LONG ANDRE CARGO BIKE A		CREATED BY A. PARDO		APPROVED BY D. Jaeger	
PART NAME wL_lacb_2.7_Shaft-extension		PART CODE 2.7		DOCUMENT TYPE Production	
 		LICENSE CC-BY-SA 4.0		FILE NAME wL_lacb_2.7_Shaft-extension.ipt	
		SCALE 1:1		VERSION 1.0	
		SHEET 21		QUANTITY 1	
		DATE 28/12/2020			

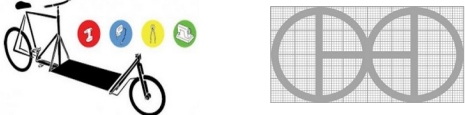

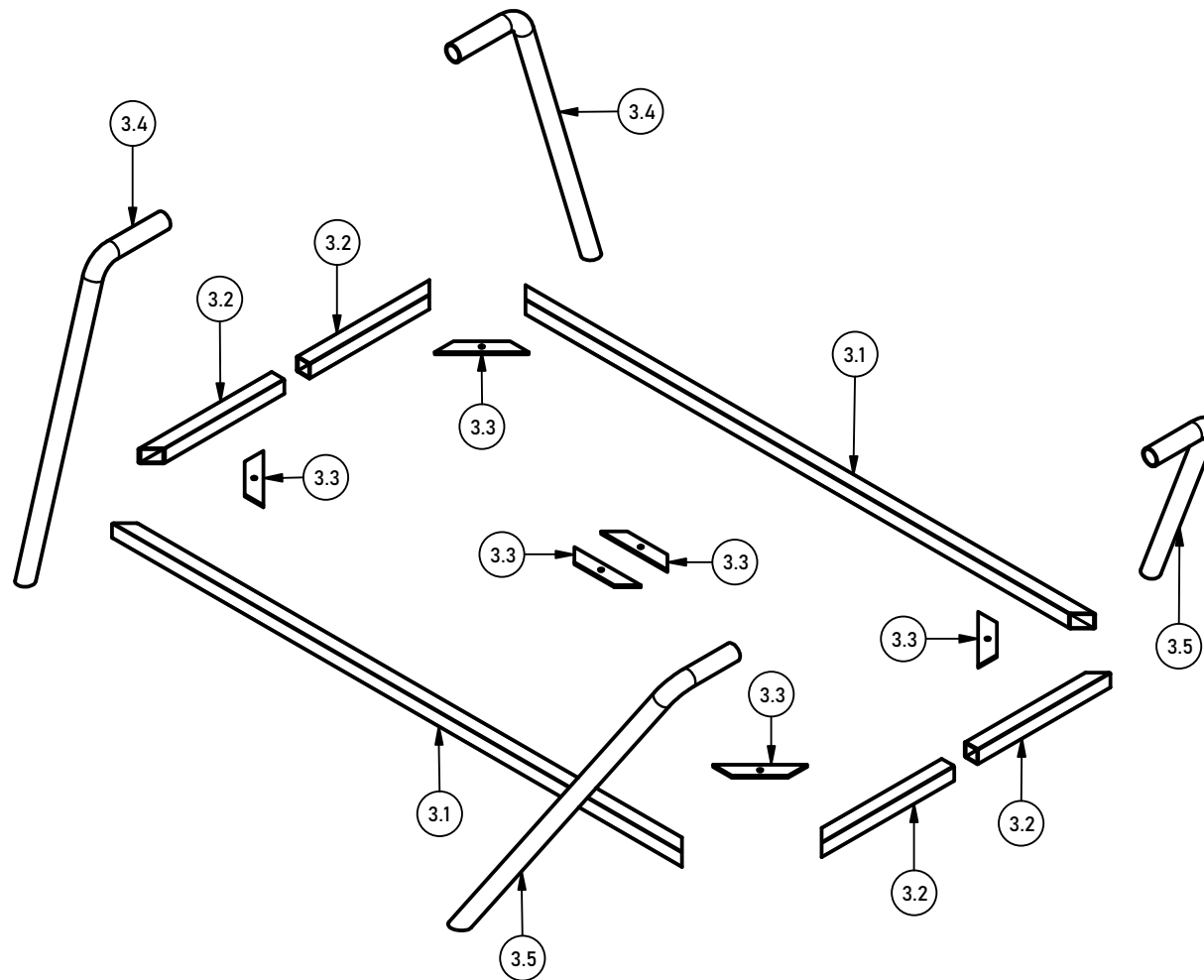

PROJECT LONG ANDRE CARGO BIKE A		CREATED BY A. PARDO		APPROVED BY D. Jaeger	
PART NAME wL_lacb_2.8_Angle-handlebar		PART CODE 2.8		DOCUMENT TYPE Production	
		LICENSE CC-BY-SA 4.0		FILE NAME wL_lacb_2.8_Angle-handlebar.ipt	
		SCALE 1:1		MATERIAL A36	
		VERSION 1.0		QUANTITY 1	
		SHEET 22		DATE 29/12/2020	

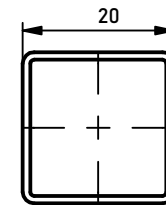
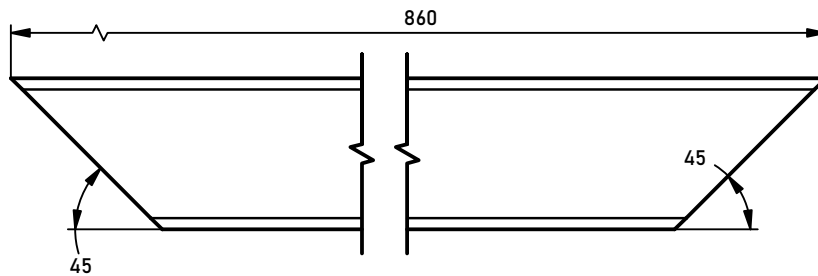
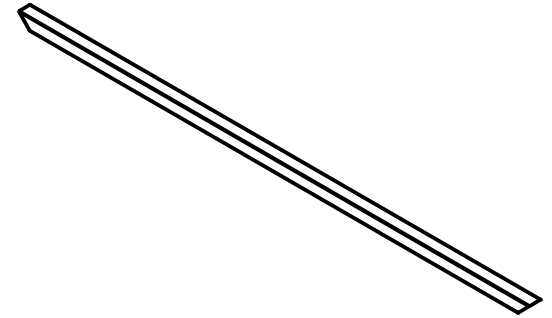

PROJECT LONG ANDRE CARGO BIKE A		CREATED BY A. PARDO		APPROVED BY D. Jaeger	
PART NAME Assembly3-Long André Cargo Bike		PART CODE 3		DOCUMENT TYPE	
 		LICENSE CC-BY-SA 4.0		FILE NAME Assembly3-Long AndréCargoBike.iam	
		SCALE 1 / 8		VERSION 1.0	
		SHEET 23		QUANTITY	
		DATE 30/12/2020			



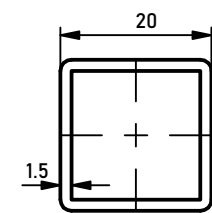
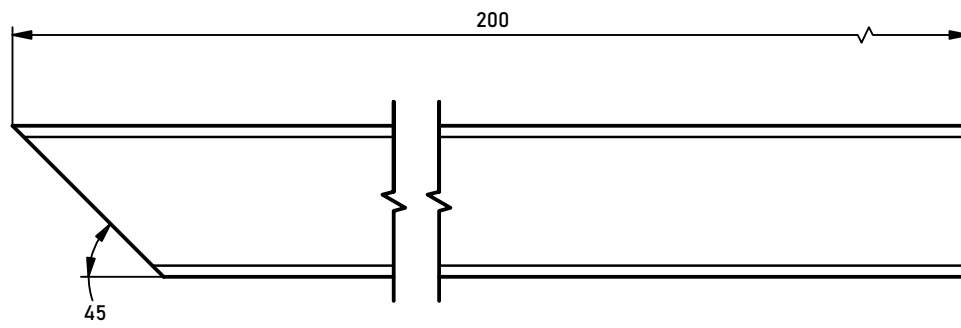
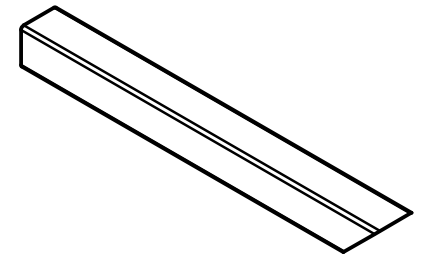

PROJECT LONG ANDRE CARGO BIKE A		CREATED BY A. PARDO		APPROVED BY D. Jaeger	
PART NAME wl_lacb_3.1_Frame-loading-area		PART CODE 3.1		DOCUMENT TYPE Production	
 		LICENSE CC-BY-SA 4.0		MATERIAL A36	
		FILE NAME wl_lacb_3.1_Frame-loading-area		VERSION pt 1.0	QUANTITY 1
		SCALE 1:1		SHEET 24	DATE 30/12/2020

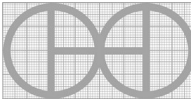

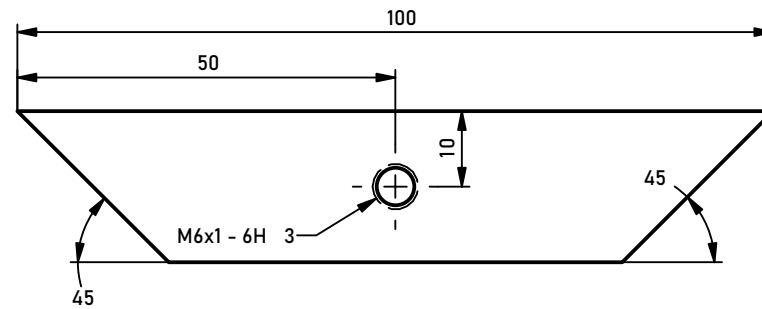
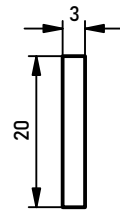
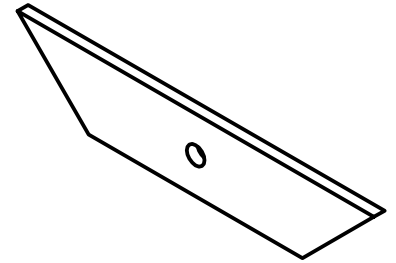
PROJECT LONG ANDRE CARGO BIKE A		CREATED BY A. PARDO		APPROVED BY D. Jaeger	
PART NAME wl_lacb_3.2_Frame-loading-area		PART CODE 3.2		DOCUMENT TYPE Production	
 		LICENSE CC-BY-SA 4.0		MATERIAL A36	
		FILE NAME wl_lacb_3.2_Frame-loading-area		VERSION pt1.0	QUANTITY 1
		SCALE 1:1		SHEET 25	DATE 30/12/2020



PROJECT LONG ANDRE CARGO BIKE A		CREATED BY A. PARDO		APPROVED BY D. Jaeger	
PART NAME wL_lacb_3.3_Mounting-bracket		PART CODE 3.3		DOCUMENT TYPE Production	
 		LICENSE CC-BY-SA 4.0		FILE NAME wL_lacb_3.3_Mounting-bracket.ipt	
		SCALE 1:1		MATERIAL A36	
		VERSION 1.0		QUANTITY 1	
		SHEET 26		DATE 30/12/2020	

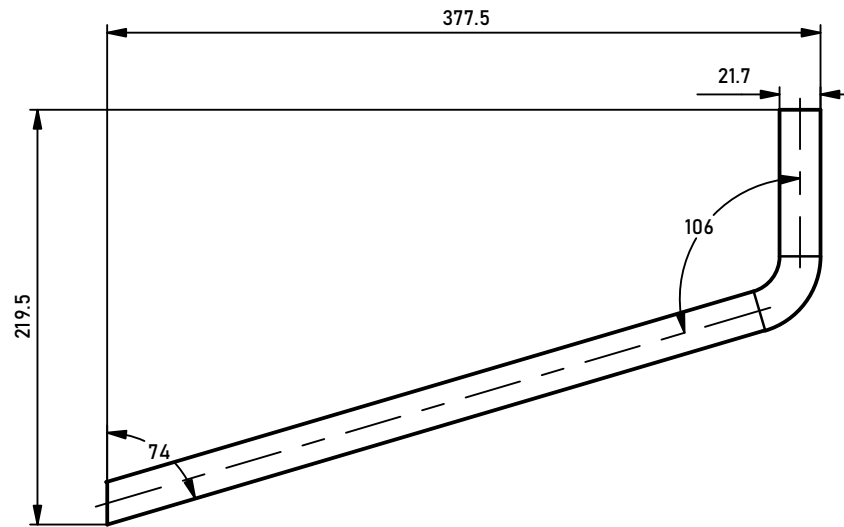
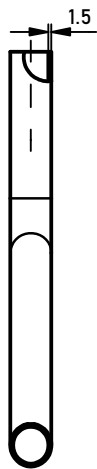
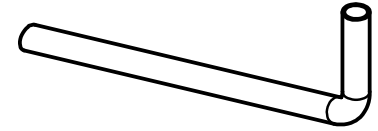

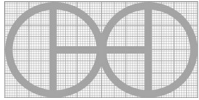
PROJECT LONG ANDRE CARGO BIKE A		CREATED BY A. PARDO		APPROVED BY D. Jaeger	
PART NAME wl_lacb_3.4_Bracket-loading-area		PART CODE 3.4		DOCUMENT TYPE Production	
 		LICENSE CC-BY-SA 4.0		MATERIAL A36	
		FILE NAME wl_lacb_3.4_Bracket-loading-area.ipk		VERSION 0	
		SCALE 1 / 4		SHEET 27	
				DATE 30/12/2020	

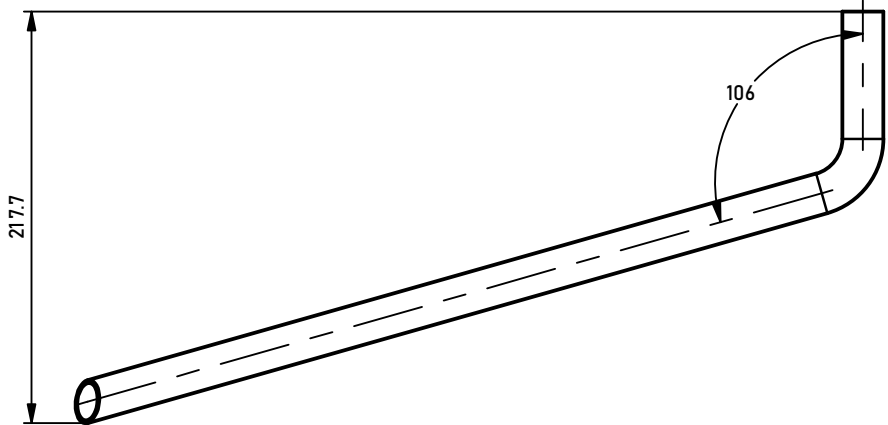
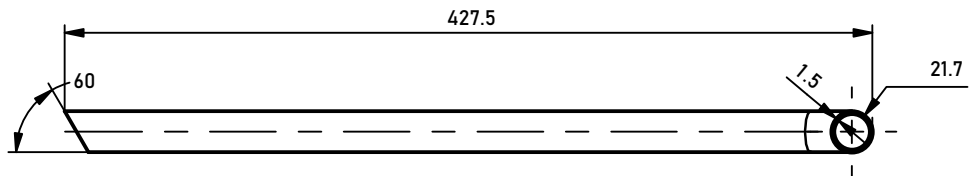
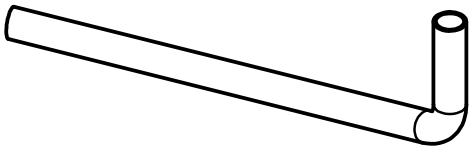

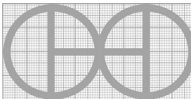
PROJECT LONG ANDRE CARGO BIKE A		CREATED BY A. PARDO		APPROVED BY D. Jaeger	
PART NAME wL_lacb_3.5_Bracket-loading-area		PART CODE 3.5		DOCUMENT TYPE Production	
 		LICENSE CC-BY-SA 4.0		MATERIAL A36	
		FILE NAME wL_lacb_3.5_Bracket-loading-area.ipt		VERSION 0	
		SCALE 1 / 4		QUANTITY 1	
		SHEET 28		DATE 30/12/2020	