

C (1 : 6)

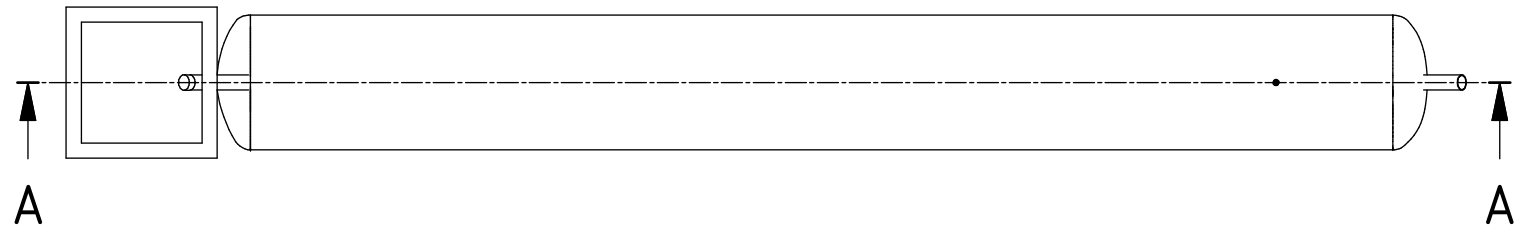

A-A (1 : 50)

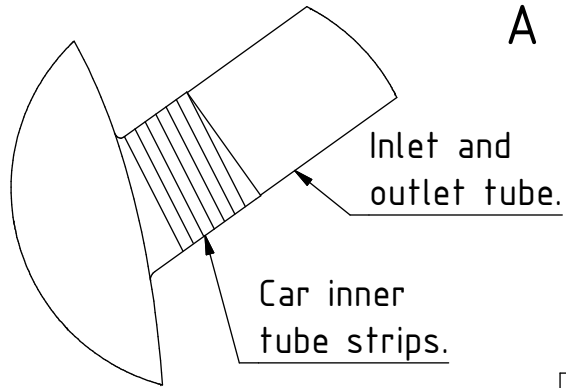
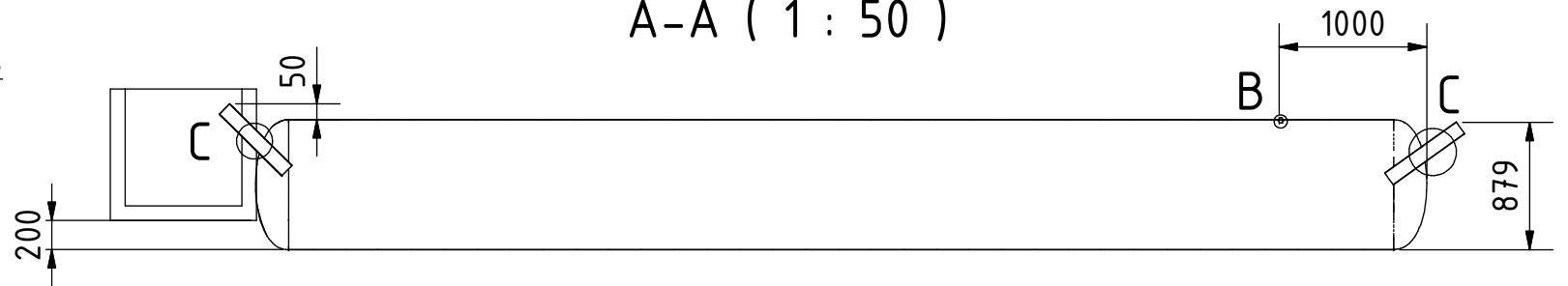

B (1 : 2)

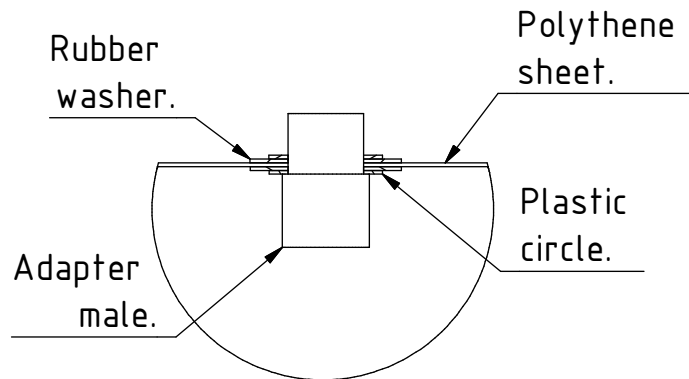

Note: All units in mm.

PROJECT	CREATED BY	APPROVED BY	DATE	VERSION
Tubular plastic biodigester	J. Zeron	A. Morillo	18/09/2021	1.0
PART NAME	FILE NAME			POS
Pit	Pit.ipn			1.0
DEVELOPED BY	REDESIGNED BY	DOC. TYPE	MATERIAL	QUANTITY
University of Aarhus	 OSEG	Assembly		1
		LICENCE	SCALE	SHEET
		CC-BY-SA 4.0	1:50	6 /18

A (1 : 5)

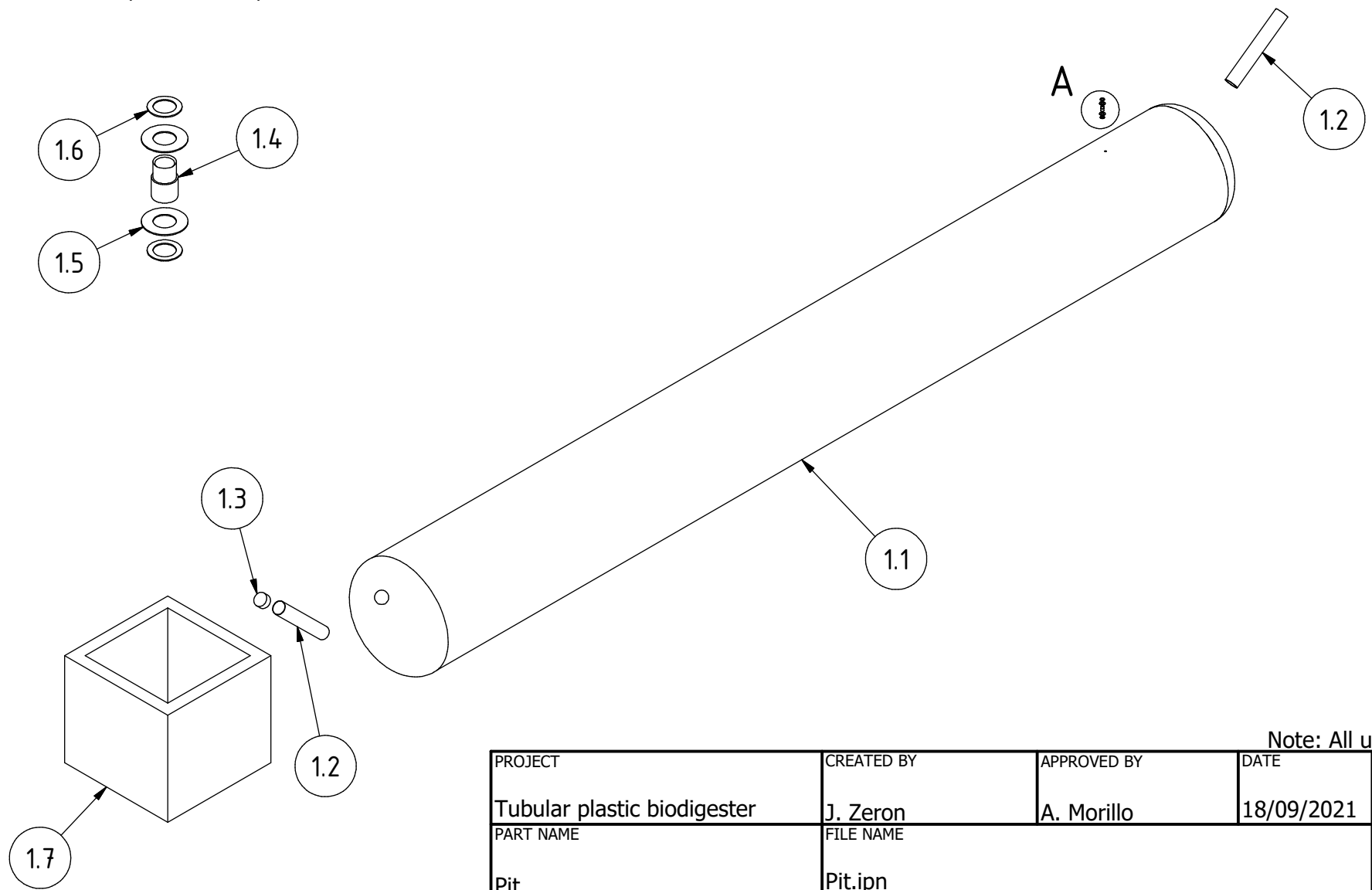

Note: All units in mm.

PROJECT	CREATED BY	APPROVED BY	DATE	VERSION
Tubular plastic biodigester	J. Zeron	A. Morillo	18/09/2021	1.0
PART NAME	FILE NAME			POS
Pit	Pit.ipn			1.0
DEVELOPED BY	REDESIGNED BY	DOC. TYPE	MATERIAL	QUANTITY
	 <small>OPEN SOURCE ECOLOGY GERMANY</small>	Assembly		1
University of Aarhus		OSEG	LICENCE	SCALE
		CC-BY-SA 4.0	1:40	7 /18