







PROJEKT <b>Bienenstock-Rahmen</b>	ERSTELLT VON A. PARDO	GENEHMIGT VON		
TEIL-NAME BEE HIVE FRAMES	TEIL-CODE 1	DOKUMENTTYP ASSEMBLY	WERKSTOFF WOOD	
 <small>OPEN SOURCE ECOLOGY GERMANY</small>	LIZENZ 	DATEI-NAME BEE HIVE FRAMES.iam	VERSION 1.0	MENGE 1
		SCALE 1 / 8	SEITE 1 /	DATE 04-10-2020

PARTS LIST						
POS.	POS. OLD	QTY	TEIL NAME	DATEI-NAME	TEIL-TYP	SPEZIFIKATIONEN
1		1	BEE HIVE FRAMES	BEE HIVE FRAMES.iam	ASSEMBLY	
1.1		1	PARTS LIST	PARTS LIST.iam	ASSEMBLY	
1.2		1	BROOD CHAMBER	BROOD CHAMBER.iam	ASSEMBLY	
1.3		2	BROOD CHAMBER A	BROOD CAMBER A.ipt	PART	
1.4		2	BROOD CHAMBER B	BROOD CHAMBER B.ipt	PART	
1.5		2	BROOD CHAMBER C	BROOD CHAMBER C.ipt	PART	
1.6		2	BROOD CHAMBER D	BROOD CHAMBER D.ipt	PART	
1.7		2	BROOD CHAMBER E	BROOD CHAMBER E.ipt	PART	
1.8		1	BROOD CHAMBER F	BROOD CHAMBER F.ipt	PART	
1.9		4	BROOD CHAMBER G	BROOD CHAMBER G.ipt	PART	
1.10		4	BROOD CHAMBER H	BROOD CHAMBER H.ipt	PART	
2		1	FRAME	FRAME.iam	ASSEMBLY	
2.1		1	FRAME A	FRAME A.ipt	PART	
2.2		2	FRAME B	FRAME B.ipt	PART	
2.3		1	FRAME C	FRAME C.ipt	PART	
2.4		2	FRAME D	FRAME D.ipt	PART	

PROJEKT <b>Bienenstock-Rahmen</b>	ERSTELLT VON A. PARDO	GENEHMIGT VON			
TEIL-NAME BEE HIVE FRAMES	TEIL-CODE 1.1	DOKUMENTTYP ASSEMBLY	WERKSTOFF WOOD / STEEL METAL		
	LIZENZ		DATEI-NAME PARTS LIST BEE HIVE FRAMES.iam	VERSION 1.0	MENGE 1
			SCALE 1 / 20	SEITE 2/16	DATE 01-10-2020

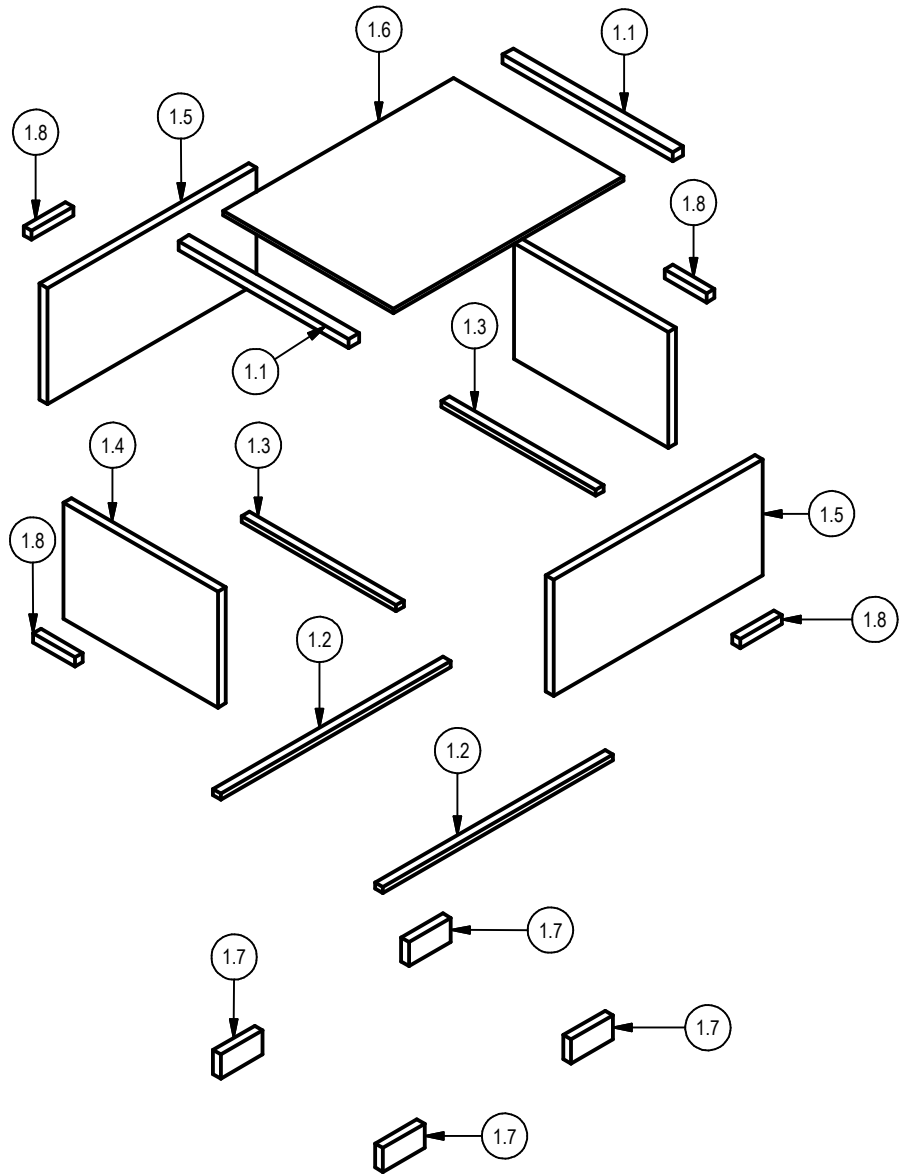

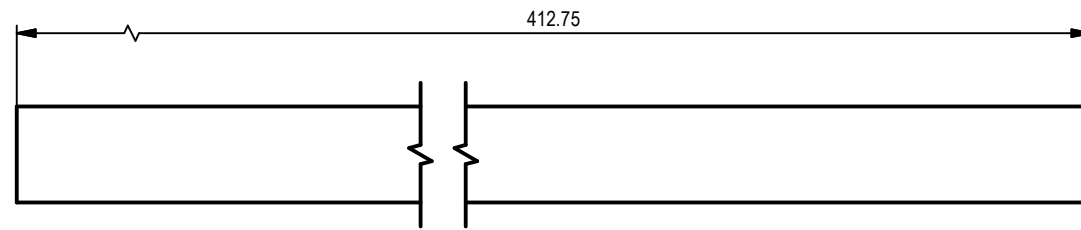
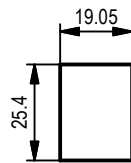
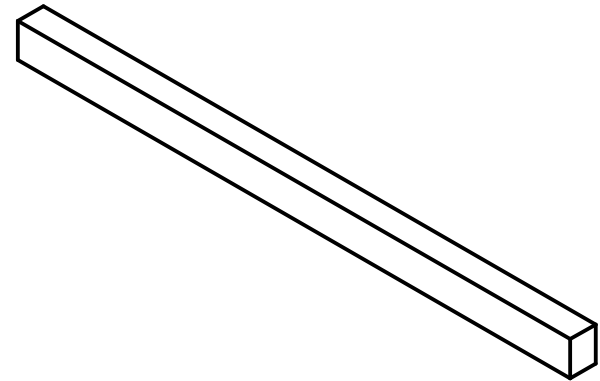

PROJEKT <b>Bienenstock-Rahmen</b>	ERSTELLT VON A. PARDO	GENEHMIGT VON		
TEIL-NAME BROOD CHAMBER	TEIL-CODE 1.2	DOKUMENTTYP ASSEMBLY	WERKSTOFF WOOD	
 <small>OPEN SOURCE ECOLOGY GERMANY</small>	LIZENZ	DATEI-NAME BROOD CHAMBER.iam	VERSION 1.0	MENGE 1
		SCALE 1 / 13	SEITE 1/16	DATE 01-10-2020

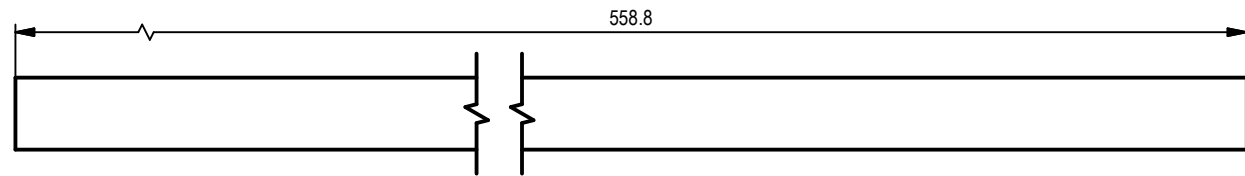
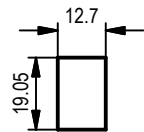
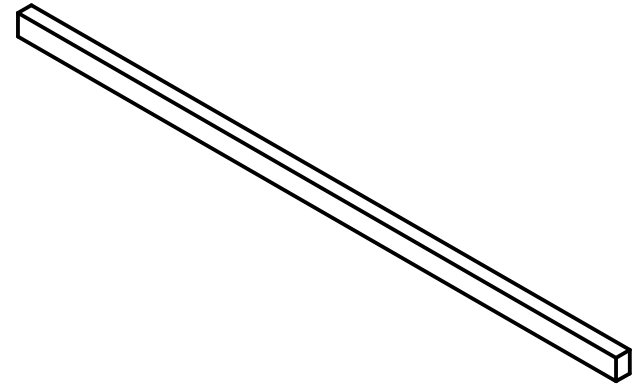

PROJEKT <b>Bienenstock-Rahmen</b>	ERSTELLT VON A. PARDO	GENEHMIGT VON		
TEIL-NAME BROOD CHAMBER A	TEIL-CODE 1.3	DOKUMENTTYP PART	WERKSTOFF WOOD	
	LIZENZ	DATEI-NAME BROOD CHAMBER A.ipt	VERSION 1.0	MENGE 1
			SCALE 1 / 2	DATE 24-09-2020



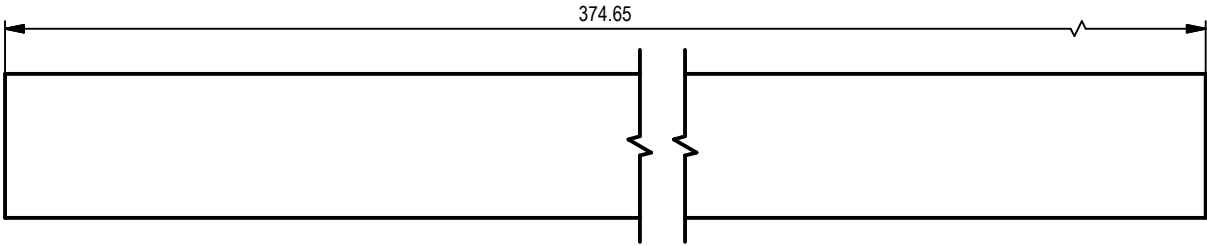
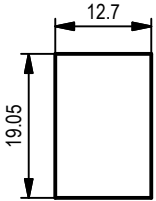
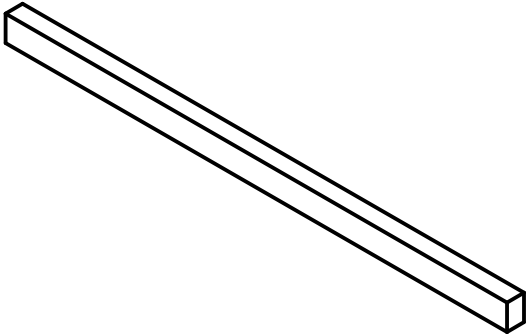

PROJEKT <b>Bienenstock-Rahmen</b>	ERSTELLT VON A. PARDO	GENEHMIGT VON		
TEIL-NAME BROOD CHAMBER B	TEIL-CODE 1.4	DOKUMENTTYP PART	WERKSTOFF WOOD	
	LIZENZ 	DATEI-NAME BROOD CHAMBER B.ipt	VERSION 1.0	MENGE 1
		SCALE 1 : 2	SEITE 5/16	DATE 24-09-2020



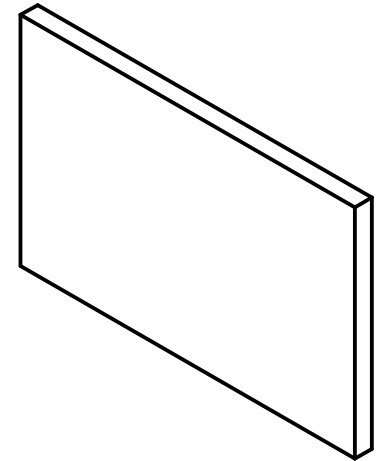
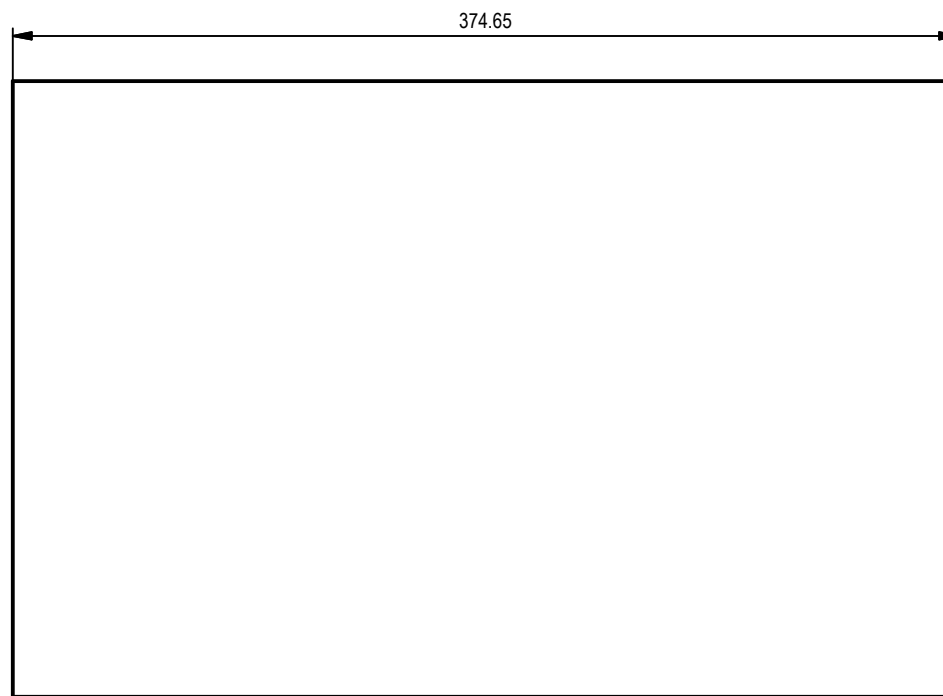
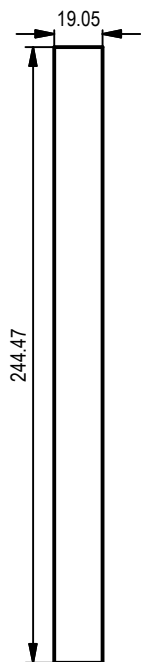

PROJEKT <b>Bienenstock-Rahmen</b>	ERSTELLT VON A. PARDO	GENEHMIGT VON		
TEIL-NAME BROOD CHAMBER C	TEIL-CODE 1.5	DOKUMENTTYP PART	WERKSTOFF WOOD	
	LIZENZ	DATEI-NAME BROOD CHAMBER C.ipt	VERSION 1.0	MENGE 1
			SCALE 1:1	DATE 24-09-2020



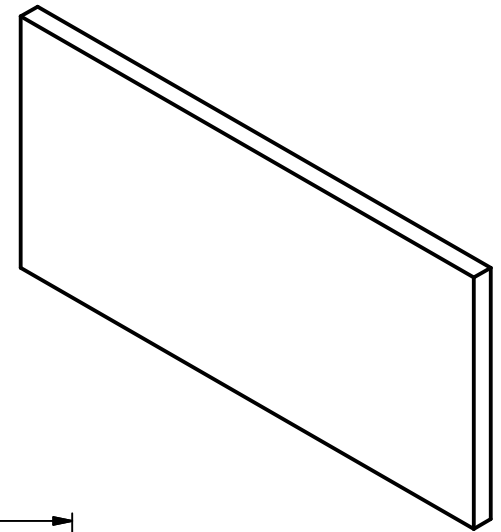
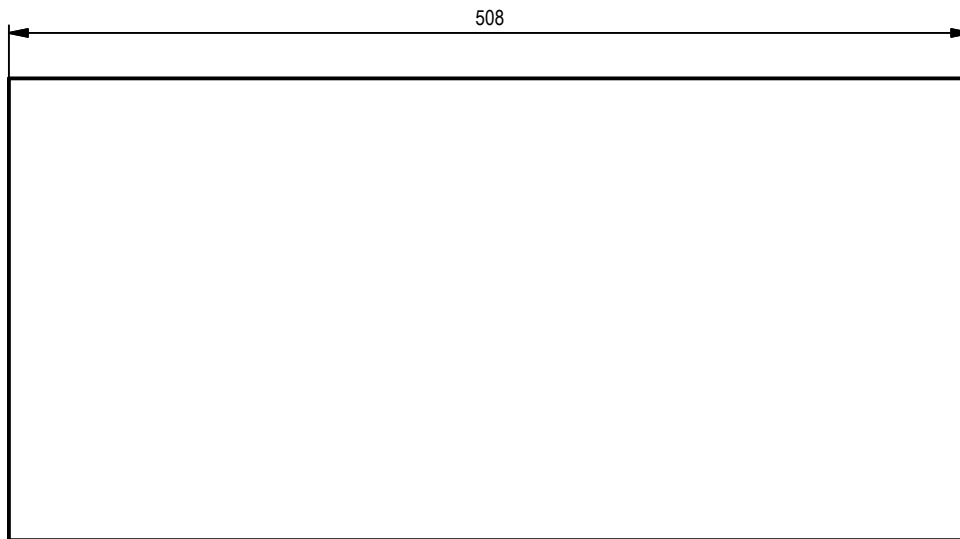
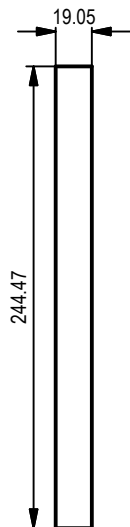

PROJEKT <b>Bienenstock-Rahmen</b>	ERSTELLT VON A. PARDO	GENEHMIGT VON		
TEIL-NAME BROOD CHAMBER D	TEIL-CODE 1.6	DOKUMENTTYP PART	WERKSTOFF WOOD	
 <small>OPEN SOURCE ECOLOGY GERMANY</small>	LIZENZ 	DATEI-NAME BROOD CHAMBER D.ipt	VERSION 1.0	MENGE 1
		SCALE 1 / 3	SEITE 7/16	DATE 24-09-2020



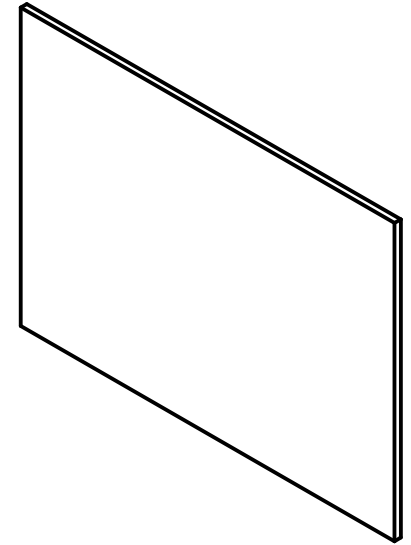
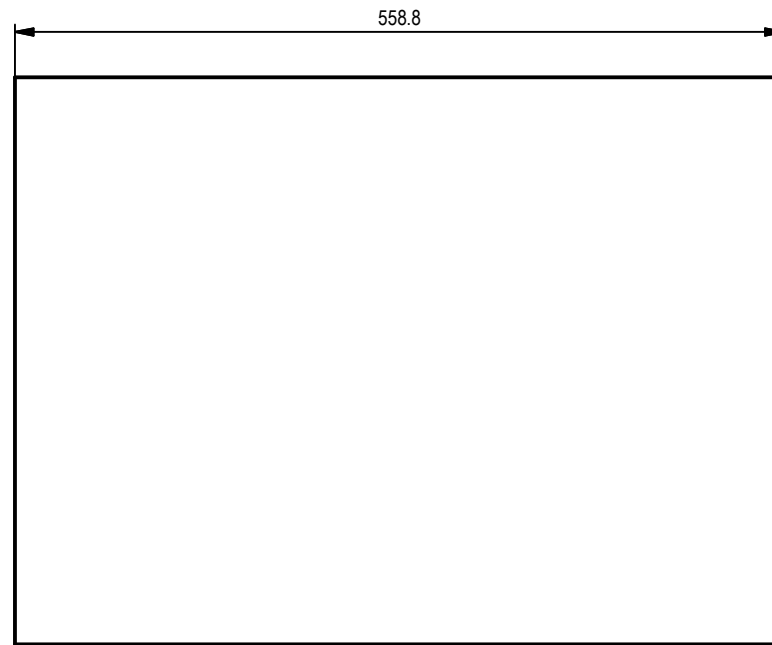
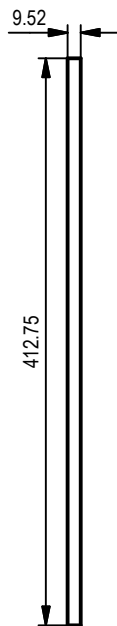

PROJEKT <b>Bienenstock-Rahmen</b>	ERSTELLT VON A. PARDO	GENEHMIGT VON		
TEIL-NAME BROOD CHAMBER E	TEIL-CODE 1.7	DOKUMENTTYP PART	WERKSTOFF WOOD	
 <small>OPEN SOURCE ECOLOGY GERMANY</small>	LIZENZ	DATEI-NAME	VERSION	MENGE
		BROOD CHAMBER E.ipt	1.0	1
		SCALE	SEITE	DATE
		1 : 4	8/16	24-09-2020





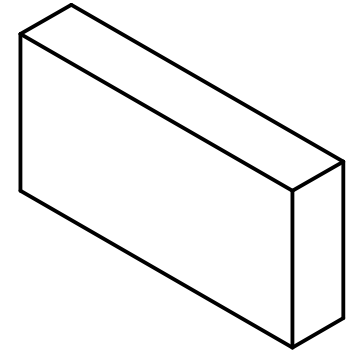
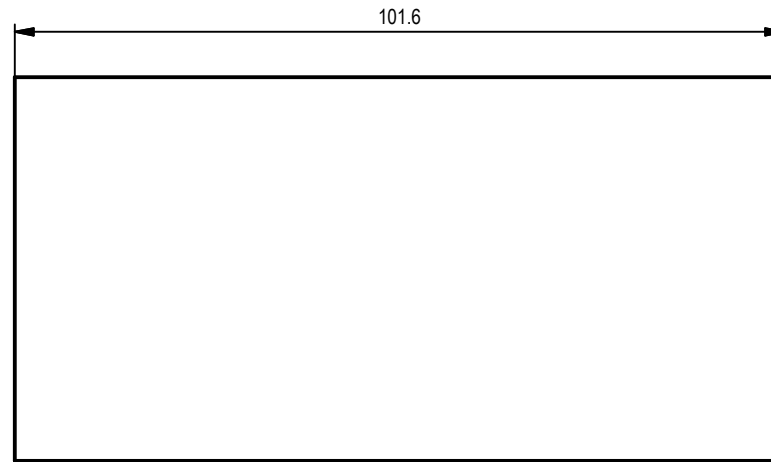
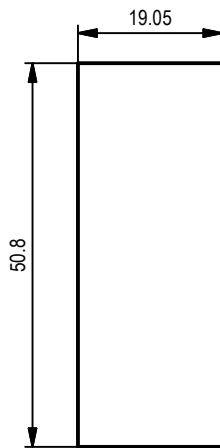

PROJEKT <b>Bienenstock-Rahmen</b>	ERSTELLT VON A. PARDO	GENEHMIGT VON		
TEIL-NAME BROOD CHAMBER F	TEIL-CODE 1.8	DOKUMENTTYP PART	WERKSTOFF WOOD	
 <small>OPEN SOURCE ECOLOGY GERMANY</small>	LIZENZ 	DATEI-NAME BROOD CHAMBER F.ipt	VERSION 1.0	MENGE 1
		SCALE 1 : 5.5	SEITE 9/16	DATE 24-09-2020



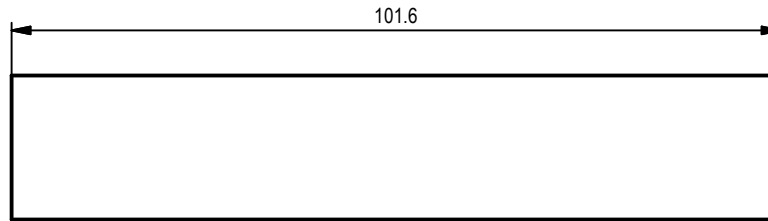
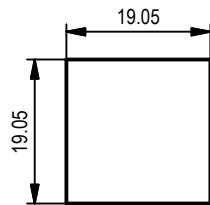
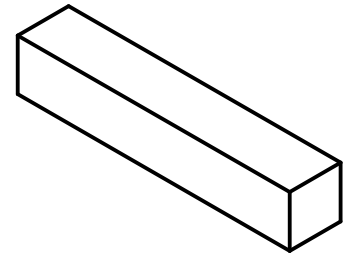

PROJEKT <b>Bienenstock-Rahmen</b>	ERSTELLT VON A. PARDO	GENEHMIGT VON			
TEIL-NAME BROOD CHAMBER G	TEIL-CODE 1.9	DOKUMENTTYP PART	WERKSTOFF WOOD		
 <small>OPEN SOURCE ECOLOGY GERMANY</small>	LIZENZ 	DATEI-NAME BROOD CHAMBER G.ipt	VERSION 1.0	MENGE 1	
		SCALE 1 : 1	SEITE 10/16	DATE 24-09-2020	



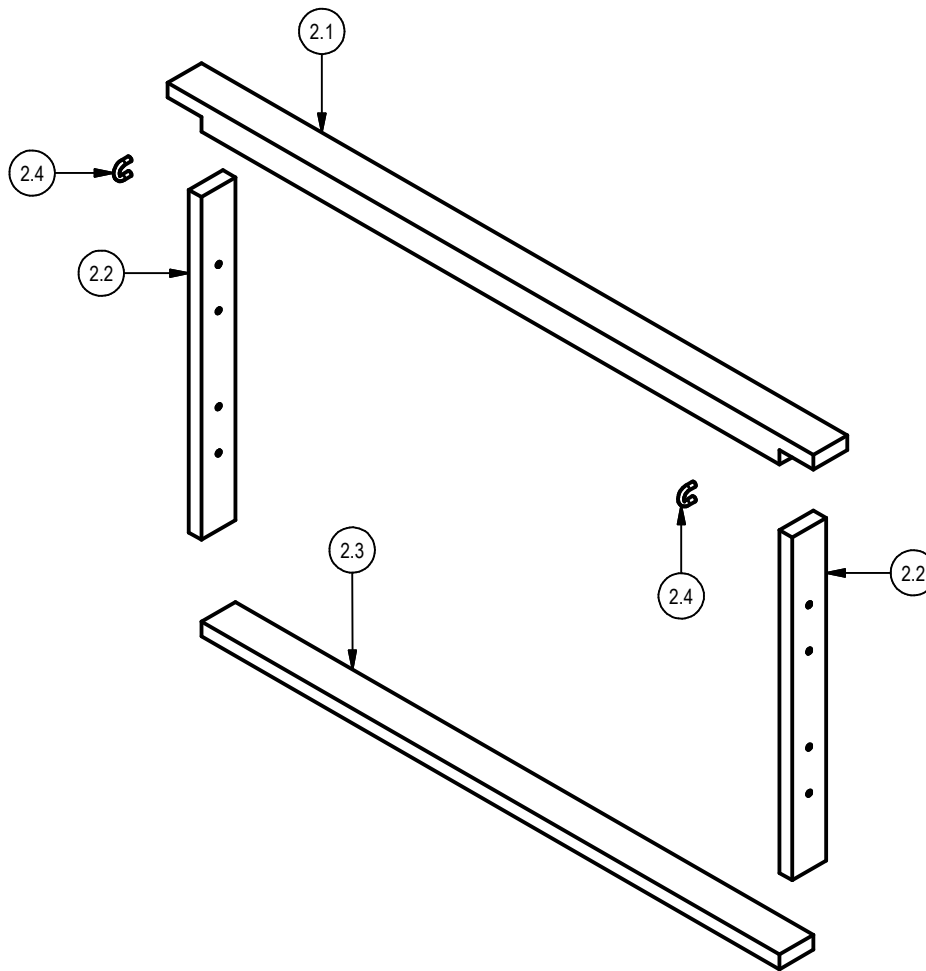

PROJEKT <b>Bienenstock-Rahmen</b>	ERSTELLT VON A. PARDO	GENEHMIGT VON			
TEIL-NAME BROOD CHAMBER H	TEIL-CODE 1.10	DOKUMENTTYP PART	WERKSTOFF WOOD		
 <small>OPEN SOURCE ECOLOGY GERMANY</small>	LIZENZ	DATEI-NAME	VERSION	MENGE	
		BROOD CHAMBER H.ipt	1.0	1	
		SCALE	SEITE	DATE	
		1 : 1	11/16	01-10-2020	

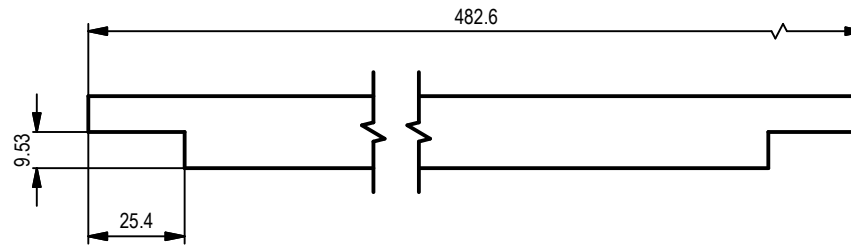
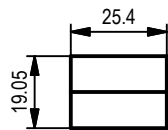
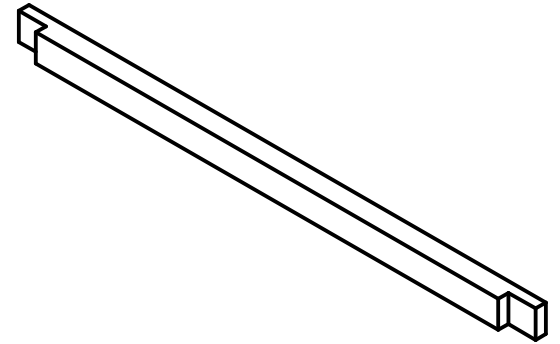

PROJEKT <b>Bienenstock-Rahmen</b>	ERSTELLT VON A. PARDO	GENEHMIGT VON		
TEIL-NAME FRAME	TEIL-CODE 2	DOKUMENTTYP ASSEMBLY	WERKSTOFF WOOD/STEEL METAL	
 OPEN SOURCE ECOLOGY GERMANY	LIZENZ	DATEI-NAME FRAME.iam	VERSION 1.0	MENGE 1
		SCALE 1 / 4	SEITE 12/16	DATE 01-10-2020



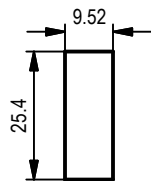
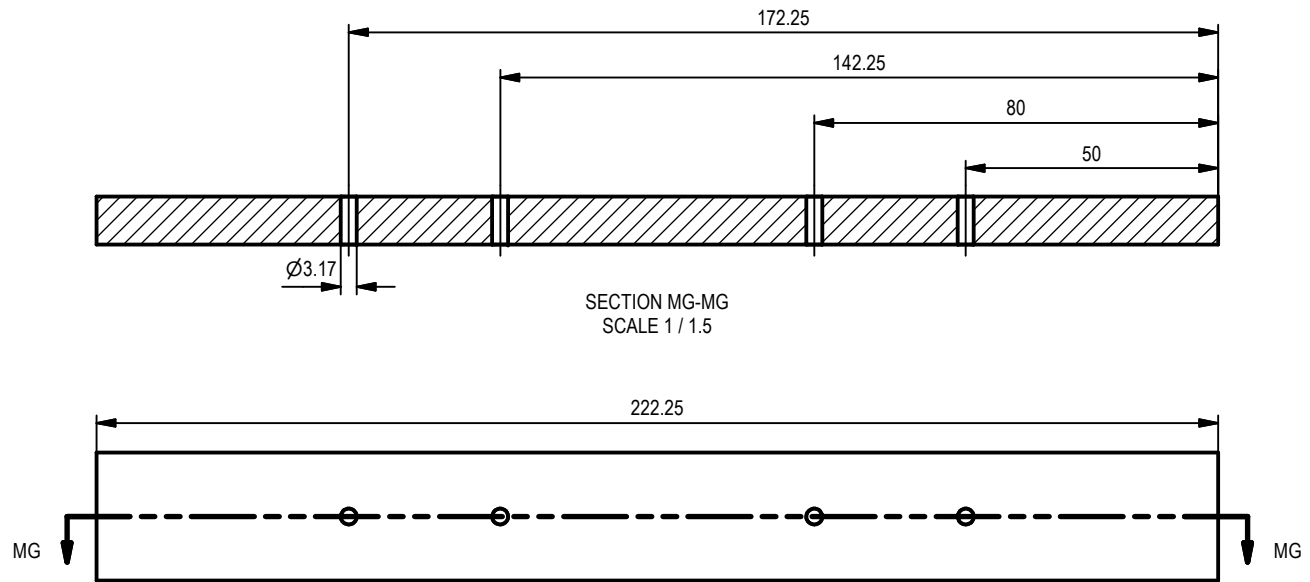
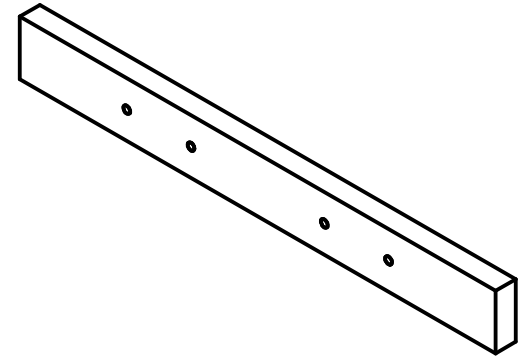

PROJEKT <b>Bienenstock-Rahmen</b>	ERSTELLT VON A. PARDO	GENEHMIGT VON		
TEIL-NAME FRAME A	TEIL-CODE 2.1	DOKUMENTTYP PART	WERKSTOFF WOOD	
 <small>OPEN SOURCE ECOLOGY GERMANY</small>	LIZENZ 	DATEI-NAME FRAME A.ipt	VERSION 1.0	MENGE 1
		SCALE 1 / 5	SEITE 13/16	DATE 24-09-2020



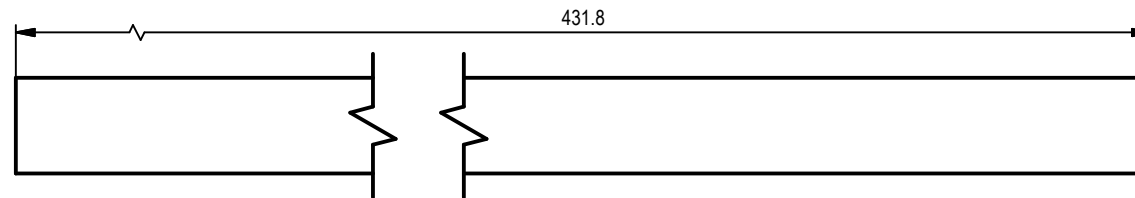
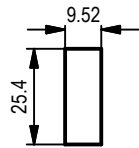
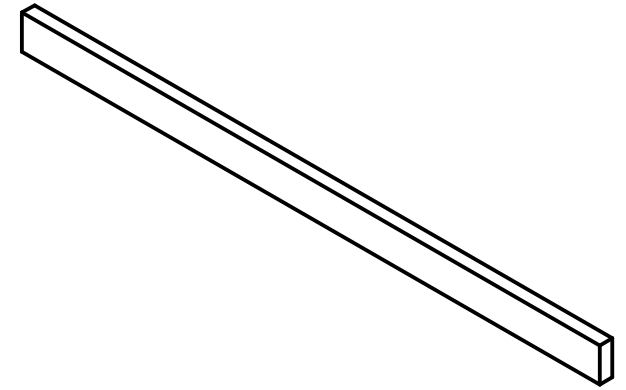

PROJEKT <b>Bienenstock-Rahmen</b>	ERSTELLT VON A. PARDO	GENEHMIGT VON		
TEIL-NAME FRAME B	TEIL-CODE 2.2	DOKUMENTTYP PART	WERKSTOFF WOOD	
 <small>OPEN SOURCE ECOLOGY GERMANY</small>	LIZENZ	DATEI-NAME FRAME B.ipt	VERSION 1.0	MENGE 1
			SCALE 1 / 1.5	DATE 24-09-2020

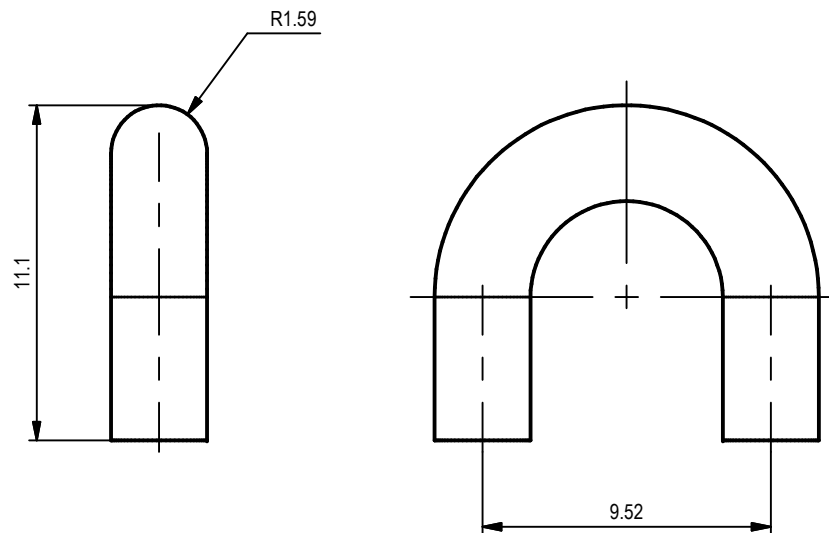
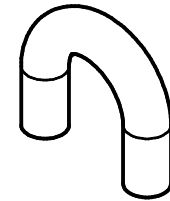

PROJEKT <b>Bienenstock-Rahmen</b>	ERSTELLT VON A. PARDO	GENEHMIGT VON			
TEIL-NAME FRAME C	TEIL-CODE 2.3	DOKUMENTTYP PART	WERKSTOFF WOOD		
 <small>OPEN SOURCE ECOLOGY GERMANY</small>	LIZENZ	DATEI-NAME	VERSION	MENGE	
		FRAME C.ipt	1.0	1	
		SCALE 1 / 2	SEITE 15/16	DATE 24-09-2020	



PROJEKT <b>Bienenstock-Rahmen</b>	ERSTELLT VON A. PARDO	GENEHMIGT VON			
TEIL-NAME FRAME D	TEIL-CODE 2.4	DOKUMENTTYP PART	WERKSTOFF STEEL METAL		
 <small>OPEN SOURCE ECOLOGY GERMANY</small>	LIZENZ	DATEI-NAME FRAME D.ipt	VERSION 1.0	MENGE 1	
		SCALE 4 : 1	SEITE 16/16	DATE 01-10-2020	