







PROJECT HONEY EXTRACTOR	CREATED BY A. PARDO	APPROVED BY		
PART NAME BEE HONEY EXTRACTOR	PART CODE 1	DOCUMENT TYPE ASSEMBLY	MATERIAL WOOD/ALUMINU/STEEL METAL	
 OPEN SOURCE ECOLOGY GERMANY	LICENSE 	FILE NAME HONEY EXTRACTOR.iam	VERSION 1.0	QUANTITY 1
		SCALE 1 / 8	SHEET 1/23	DATE 30/9/2020

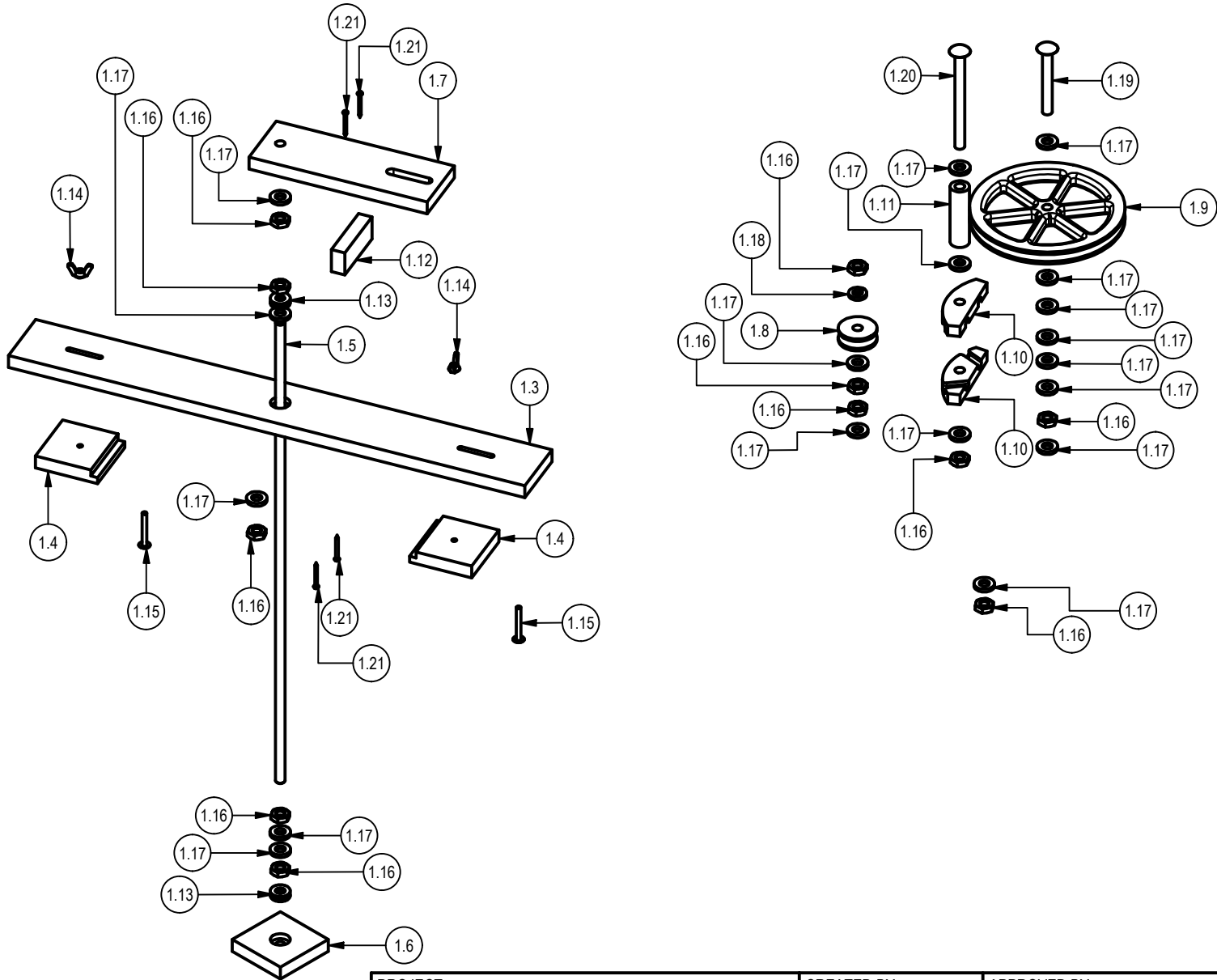

PARTS LIST						
POS.	POS. OLD	QTY	PART NAME	FILE NAME	PART TYPE	SPECIFICATIONS
1		1	HONEY EXTRACTOR	HONEY EXTRACTOR.iam	ASSEMBLY	
1.1		1	PART LIST	PART LIST.iam	ASSEMBLY	
1.2		1	SHAFT	SHAFT.iam	ASSEMBLY	
1.3		1	TOP SUPPORT	TOP SUPPORT.ipt	PART	
1.4		2	CLAMP BLOCK	CLAMP BLOCK.ipt	PART	
1.5		1	SHAFT	SHAFT.ipt	PART	
1.6		1	BEARING BLOCK	BEARING BLOCK.ipt	PART	
1.7		1	FRAME PULLEY	FRAME PULLEY.ipt	PART	
1.8		1	PULLEY A	PULLEY A.ipt	PART	
1.9		1	PULLEY B	PULLEY B.ipt	PART	
1.10		2	CURVE TO FIT INSIDE RIM	CURVE TO FIT INSIDE RIM.ipt	PART	
1.11		1	WOOD HANDLE	WOOD HANDLE.ipt	PART	
1.12		1	FRAME BLOCK	FRAME BLOCK.ipt	PART	
1.13		2	ANSI/AFBMA 24.1 TA - 12TA11 12 x 26 x 9	ANSI_AFBMA 24.1 TA - 12TA11 12 x 26 x 9.ipt	PART	
1.14		2	ANSI B18.17 - 1/4 - 20 Regular, TAWNI	ANSI B18.17 - 1_4 - 20 RegularA (1).ipt	PART	
1.15		2	ANSI B18.5 - 1/4-20 UNC - 2, RHBI	ANSI B18.5 - 1_4-20 UNC - 2(6).ipt	PART	
1.16		11	ANSI B18.2.2 - 1/2 - 13, HHJNI	ANSI B18.2.2 - 1_2 - 13(9).ipt	PART	
1.17		18	ASTM F436 - 1/2, CW	ASTM F436 - 1_2(1).ipt	PART	
1.18		1	ASME B18.21.1 - 1/2 Extra-Duty. Lock Washers (Inch Series)Extra-Duty Helical Spring Lock Washer	ASME B18.21.1 - 1_2 Extra-Duty. Lock Washers (Inch Series)Extra-Duty Helical Spring Lock Washer(7).ipt	PART	
1.19		1	ANSI B18.5 - 1/2-13 UNC - 4, RHBI	ANSI B18.5 - 1_2-13 UNC - 4(6).ipt	PART	
1.20		1	ANSI B18.5 - 1/2-13 UNC - 6, RHBI	ANSI B18.5 - 1_2-13 UNC - 6(6).ipt	PART	
1.21		4	ANSI B18.6.4 - 6-20 - 1,5, SPHTSTBI	ANSI B18.6.4 - 6-20 - 1,5(24) BP.ipt	PART	
2		1	FRAME		ASSEMBLY	
2.1		4	FRAME SIDE	FRAME SIDE.ipt	PART	
2.2		4	FRAME END	FRAME END.ipt	PART	
2.3		1	CENTER BLOCK	CENTER BLOCK.ipt	PART	
2.4		4	AIR DEFLECTOR	AIR DEFLECTOR.ipt	PART	
2.5		2	SCREEN STRIPS A	SCREEN STRIPS A.ipt	PART	
2.6		4	SCREEN STRIPS B	SCREEN STRIPS B.ipt	PART	
2.7		1	PLASTIC SCREEN	PLASTIC SCREEN.ipt	PART	
2.8		1	PIPE NIPL	PIPE NIPL.ipt	PART	
2.9		1	PERF METAL	PERF METAL.ipt	PART	

PROJECT BEE HONEY EXTRACTOR		CREATED BY A. PARDO	APPROVED BY		
PART NAME BEE HONEY EXTRACTOR		PART CODE 1.1	DOCUMENT TYPE ASSEMBLY	MATERIAL WOOD/ALUMINUM/STEEL METAL	
		LICENSE 	FILE NAME PART LIST	VERSION 1.0	QUANTITY 1
			SCALE	SHEET 2/23	DATE 29/9/2020



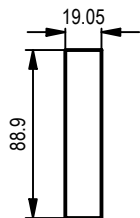
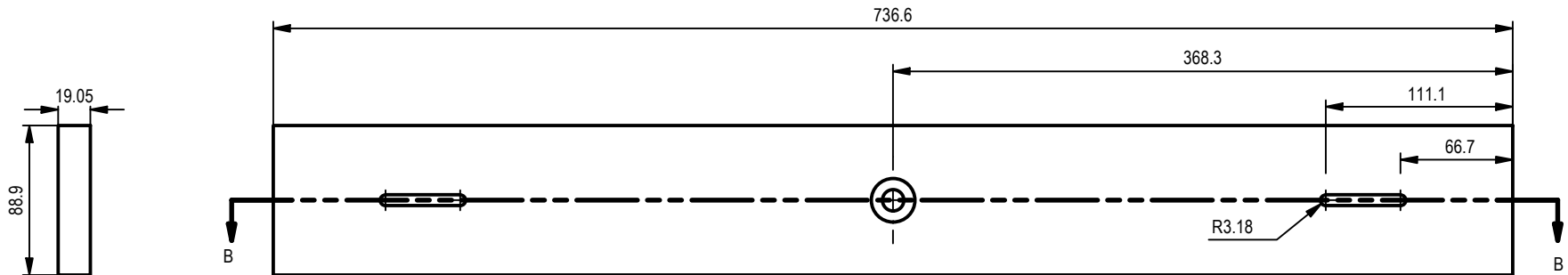
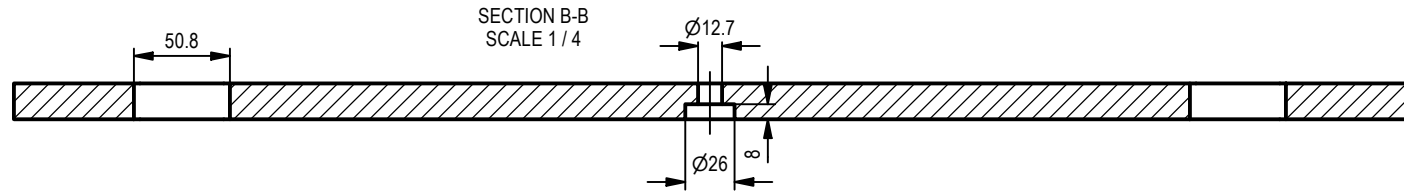
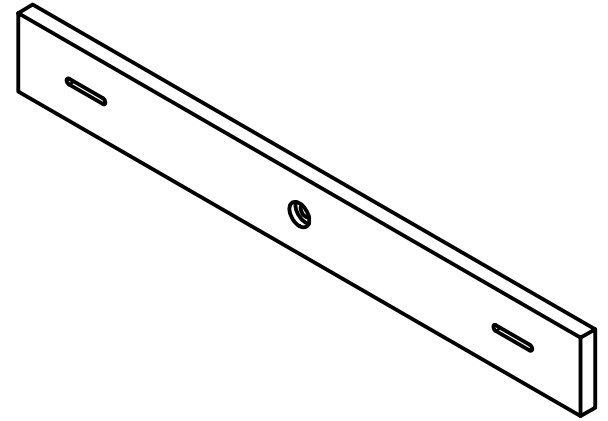

PROJECT HONEY EXTRACTOR	CREATED BY A. PARDO	APPROVED BY		
PART NAME SHAFT	PART CODE 1.2	DOCUMENT TYPE ASSEMBLY	MATERIAL WOOD/ STEEL METAL	
	LICENSE 	FILE NAME SHAFT.iam	VERSION 1.0	QUANTITY 1
		SCALE 1 / 8	SHEET 3/23	DATE 29/9/2020



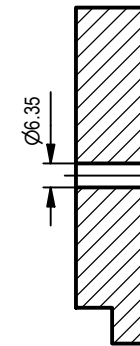
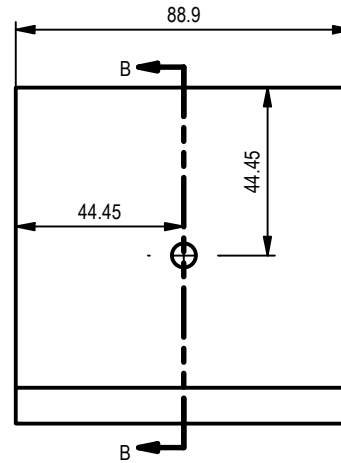
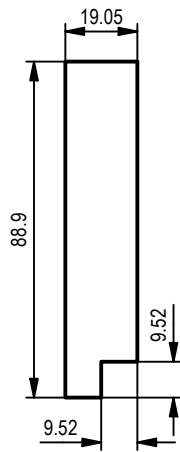
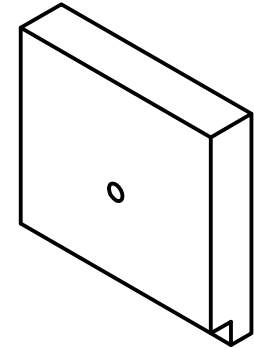

PROJECT BEE HONEY EXTRACTOR	CREATED BY A. PARDO	APPROVED BY		
PART NAME TOP SUPPORT	PART CODE 1.3	DOCUMENT TYPE PART	MATERIAL WOOD	
 OPEN SOURCE ECOLOGY GERMANY	LICENSE 	FILE NAME TOP SUPPORT.ipt	VERSION 1.0	QUANTITY 1
		SCALE 1/4	SHEET 4/23	DATE 28/9/2020



SECTION B-B
SCALE 1 / 2

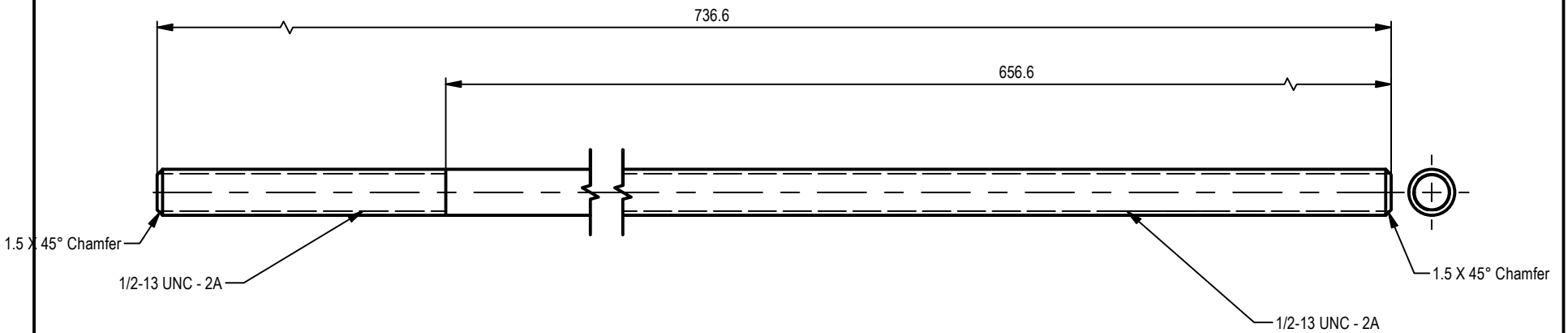
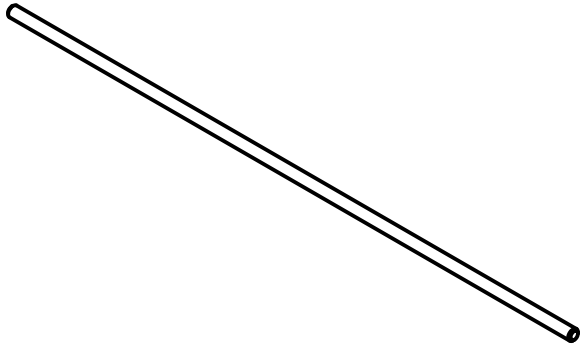

PROJECT BEE HONEY EXTRACTOR	CREATED BY A. PARDO	APPROVED BY		
PART NAME CLAMP BLOCK	PART CODE 1.4	DOCUMENT TYPE PART	MATERIAL WOOD	
	LICENSE 	FILE NAME CLAMP BLOCK.ipt	VERSION 1.0	QUANTITY 1
		SCALE 1 / 2	SHEET 5/23	DATE 28/9/2020

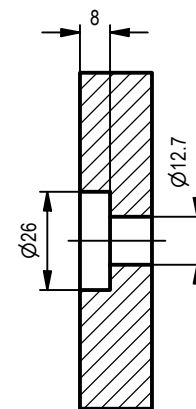
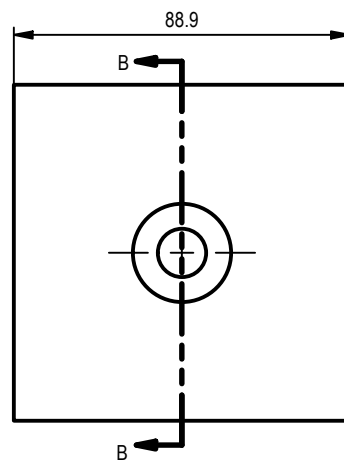
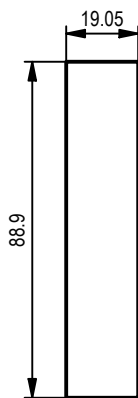
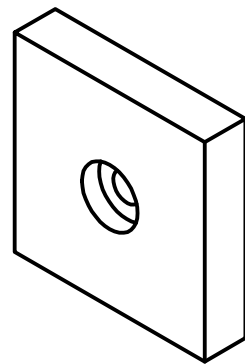

PROJECT BEE HONEY EXTRACTOR		CREATED BY A. PARDO		APPROVED BY	
PART NAME SHAFT		PART CODE 1.5		DOCUMENT TYPE PART	MATERIAL STEEL METAL
 <small>OPEN SOURCE ECOLOGY GERMANY</small>		LICENSE 		FILE NAME SHAFT.ipt	VERSION 1.0
				SCALE 1 : 1.7	SHEET 6/23
					DATE 29/9/2020



SECTION B-B
SCALE 1/2

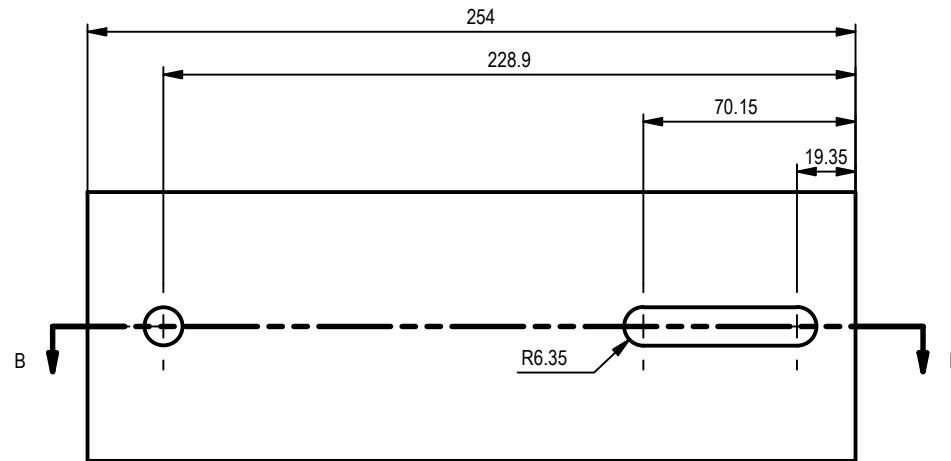
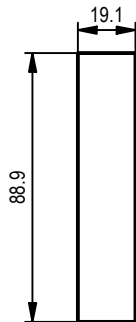
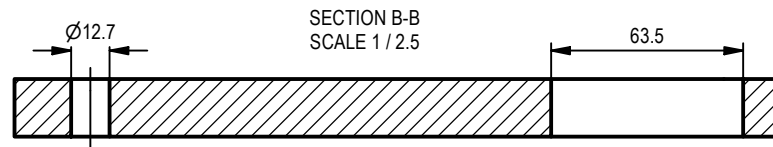
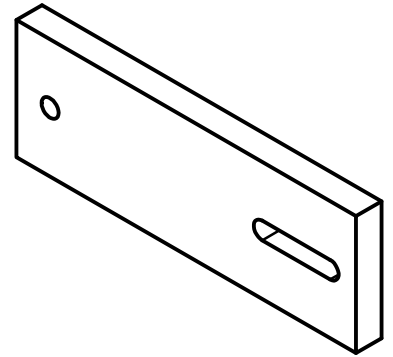

PROJECT BEE HONEY EXTRACTOR	CREATED BY A. PARDO	APPROVED BY		
PART NAME BEARING BLOCK	PART CODE 1.6	DOCUMENT TYPE PART	MATERIAL WOOD	
	LICENSE 	FILE NAME BEARING BLOCK.ipt	VERSION 1.0	QUANTITY 1
		SCALE 1/2	SHEET 7/23	DATE 29/9/2020

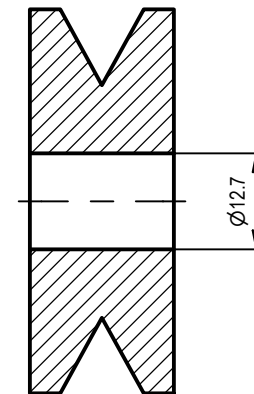
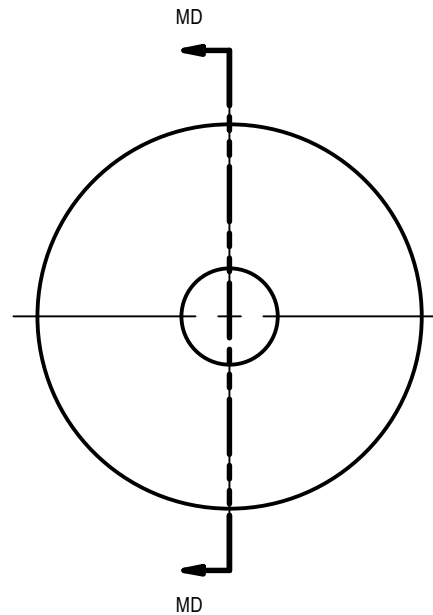
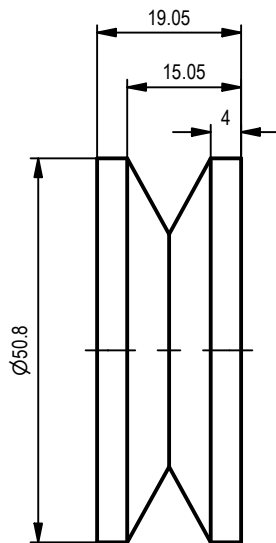
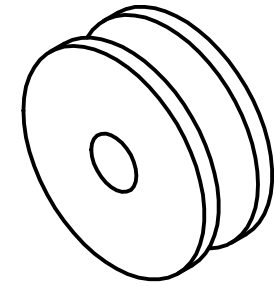

PROJECT BEE HONEY EXTRACTOR	CREATED BY A. PARDO	APPROVED BY		
PART NAME FRAME PULLEY	PART CODE 1.7	DOCUMENT TYPE PART	MATERIAL WOOD	
 OPEN SOURCE ECOLOGY GERMANY	LICENSE 	FILE NAME FRAME PULLEY.ipt	VERSION 1.0	QUANTITY 1
		SCALE 1 / 2.5	SHEET 8/23	DATE 29/9/2020



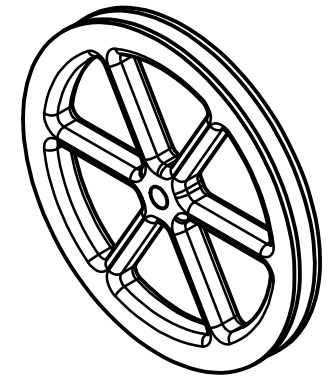
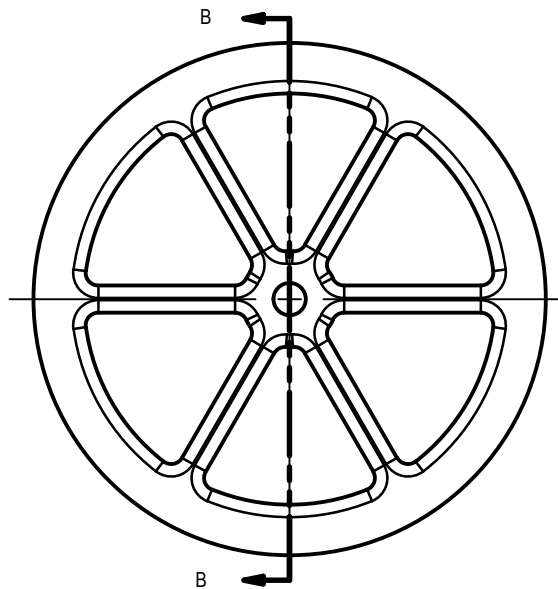
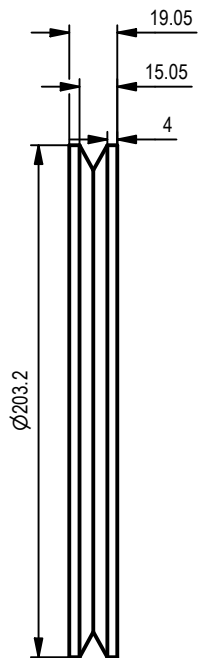

SECTION MD-MD
SCALE 1 : 1

PROJECT BEE HONEY EXTRACTOR	CREATED BY A. PARDO	APPROVED BY		
PART NAME PULLEY A	PART CODE 1.8	DOCUMENT TYPE PART	MATERIAL ALUMINUM	
	LICENSE 	FILE NAME PULLEY A.ipt	VERSION 1.0	QUANTITY 1
		SCALE 1 : 1	SHEET 9/23	DATE 29/9/2020



SECTION B-B
SCALE 1 / 3

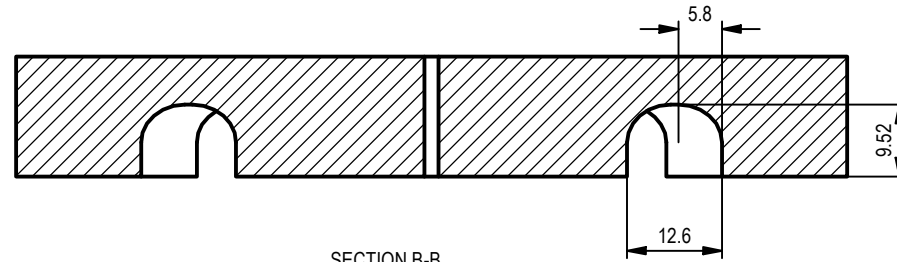
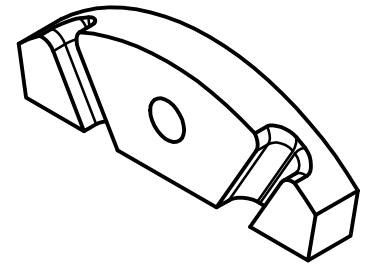

PROJECT BEE HONEY EXTRACTOR	CREATED BY A. PARDO	APPROVED BY		
PART NAME PULLEY B	PART CODE 1.9	DOCUMENT TYPE PART	MATERIAL ALUMINUM	
	LICENSE 	FILE NAME PULLEY B.ipt	VERSION 1.0	QUANTITY 1
		SCALE 1 / 3	SHEET 10/23	DATE 29/9/2020

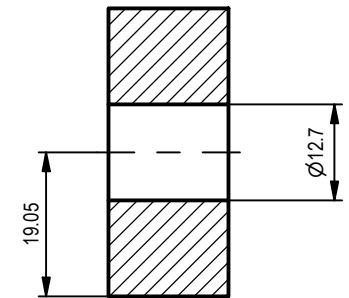
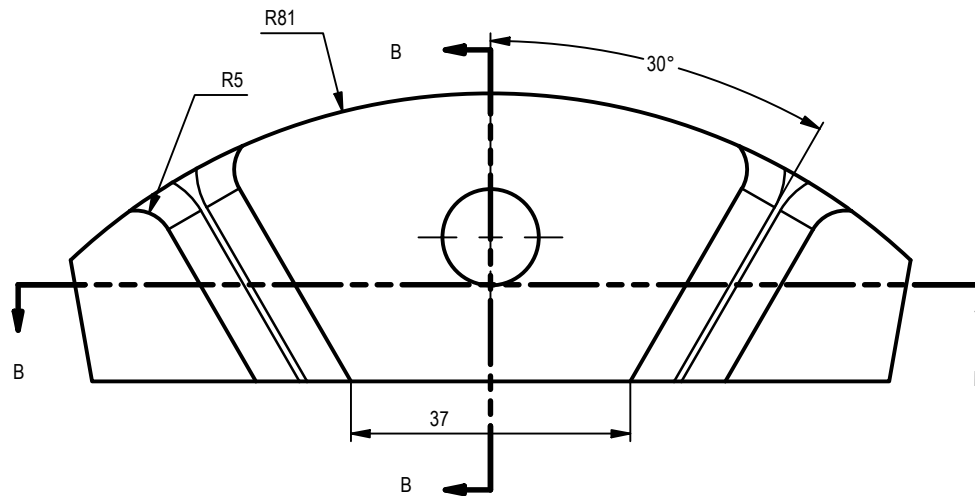
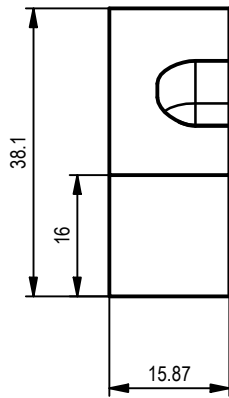

SECTION B-B
SCALE 1 : 1





SECTION B-B
SCALE 1 : 1

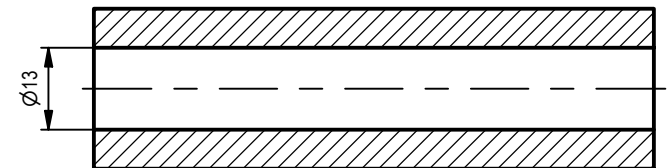
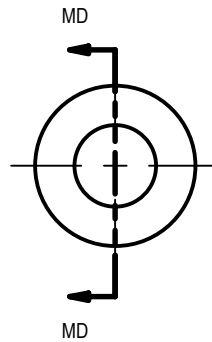
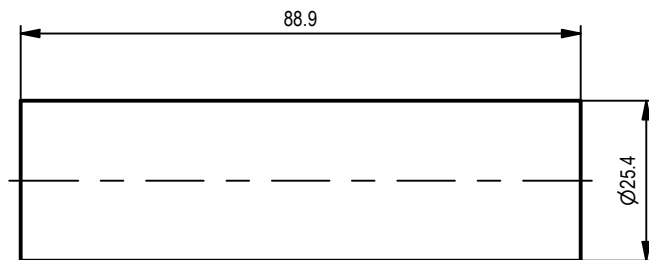
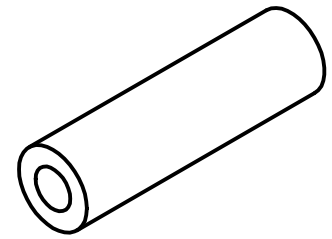

PROJECT BEE HONEY EXTRACTOR	CREATED BY A. PARDO	APPROVED BY		
PART NAME CURVE TO FIT INSIDE RIM	PART CODE 1.10	DOCUMENT TYPE PART	MATERIAL WOOD	
 OPEN SOURCE ECOLOGY GERMANY	LICENSE 	FILE NAME CURVE TO FIT INSIDE RIM.ipt	VERSION 1.0	QUANTITY 1
		SCALE 1 : 1	SHEET 11/23	DATE 29/9/2020



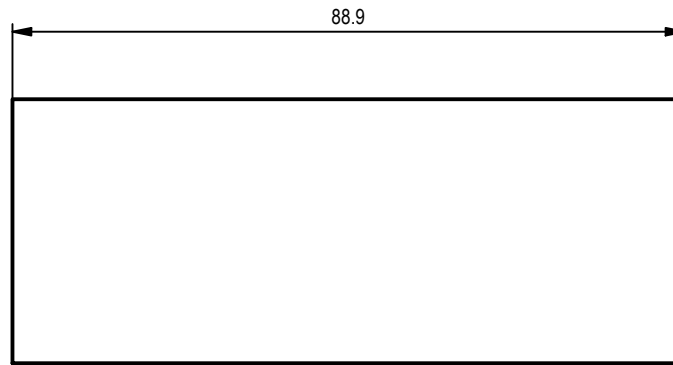
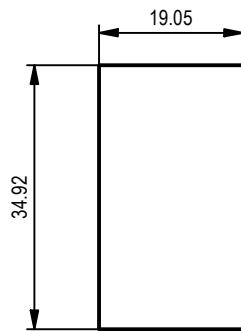
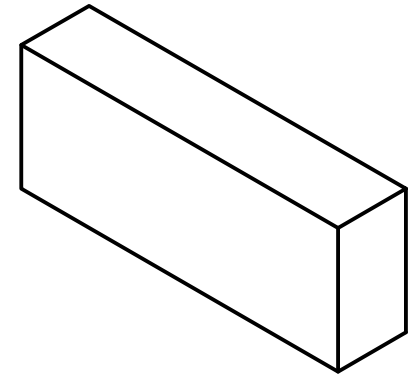

SECTION MD-MD
SCALE 1 : 1.2

PROJECT BEE HONEY EXTRACTOR	CREATED BY A. PARDO	APPROVED BY		
PART NAME WOOD HANDLE	PART CODE 1.11	DOCUMENT TYPE PART	MATERIAL WOOD	
	LICENSE 	FILE NAME WOOD_HANDLE.ipt	VERSION 1.0	QUANTITY 1
		SCALE 1 : 1.2	SHEET 12/23	DATE 29/9/2020



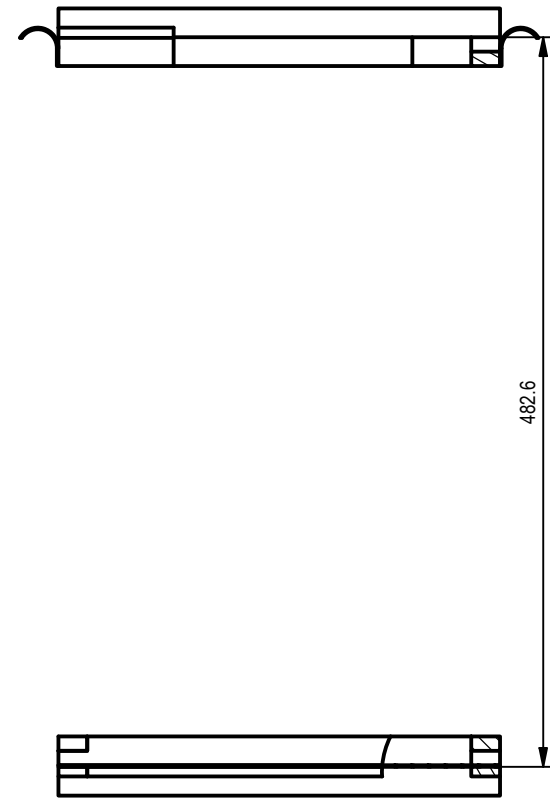
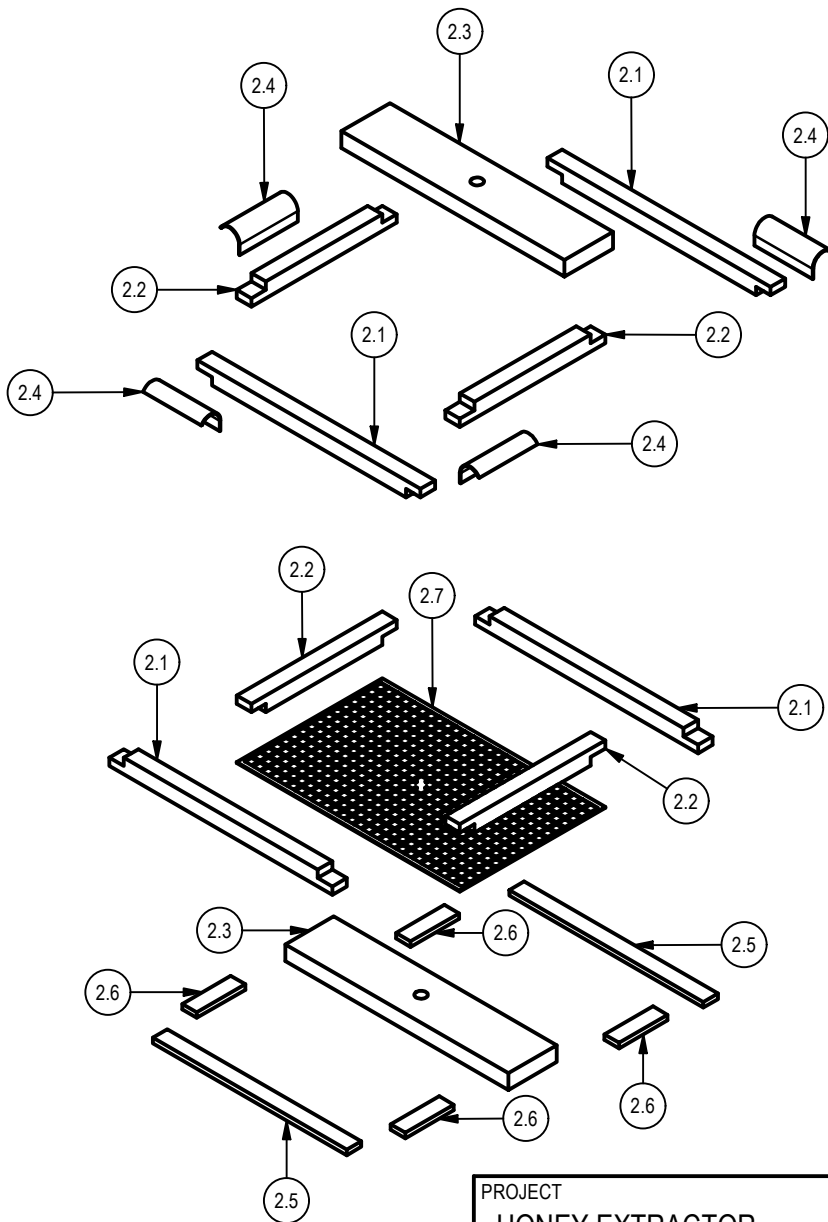

PROJECT BEE HONEY EXTRACTOR		CREATED BY A. PARDO		APPROVED BY	
PART NAME FRAME BLOCK		PART CODE 1.12		DOCUMENT TYPE PART	
 OPEN SOURCE ECOLOGY GERMANY		LICENSE 		MATERIAL WOOD	
		FILE NAME FRAME BLOCK.ipt		VERSION 1.0	QUANTITY 1
		SCALE 1 : 1		SHEET 13/23	DATE 29/9/2020



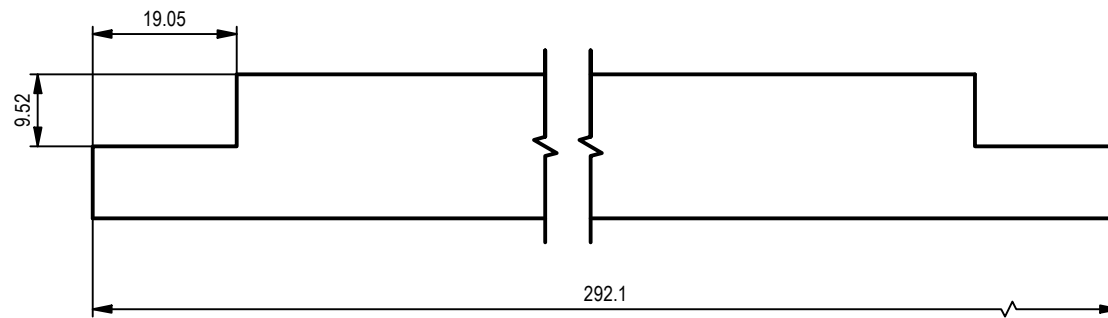
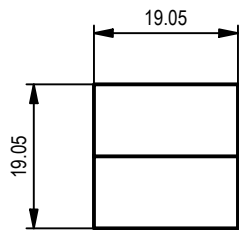
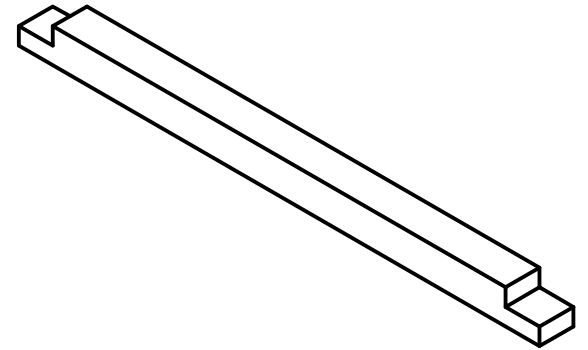

PROJECT HONEY EXTRACTOR	CREATED BY A. PARDO	APPROVED BY		
PART NAME TOP FRAME	PART CODE 2	DOCUMENT TYPE ASSEMBLY	MATERIAL WOOD/ ALIMINIUM	
	LICENSE 	FILE NAME FRAME.iam	VERSION 1.0	QUANTITY 1
		SCALE 1 / 7	SHEET 14/23	DATE 29/9/2020



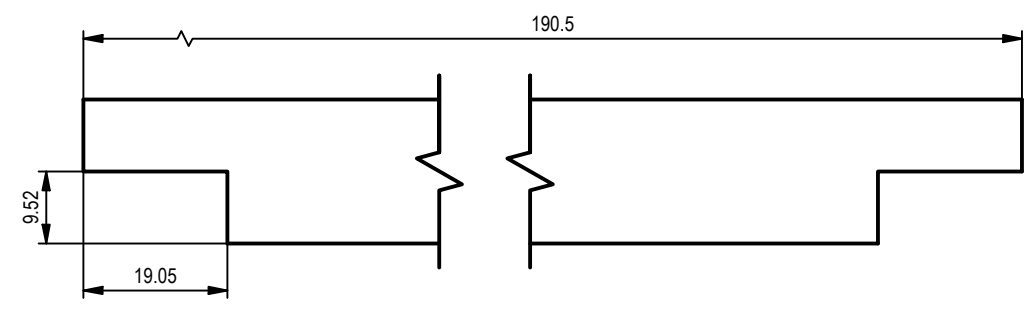
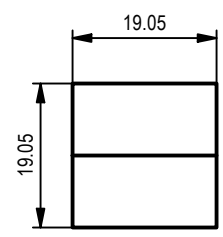
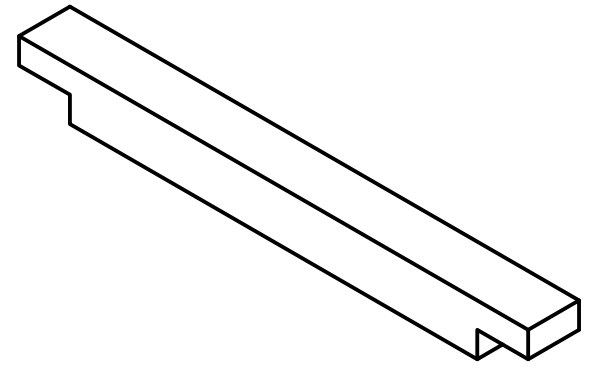

PROJECT BEE HONEY EXTRACTOR		CREATED BY A. PARDO		APPROVED BY	
PART NAME FRAME SIDE		PART CODE 2.1		DOCUMENT TYPE PART	
		LICENSE 		MATERIAL WOOD	
		FILE NAME FRAME SIDE.ipt		VERSION 1.0	QUANTITY 1
		SCALE 1 / 1	SHEET 15/23	DATE 29/9/2020	



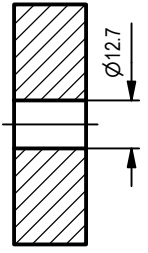
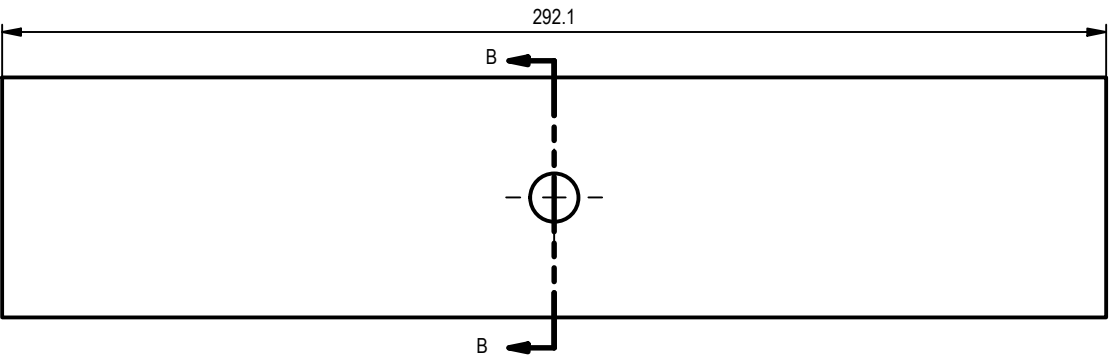
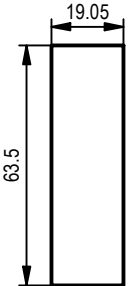
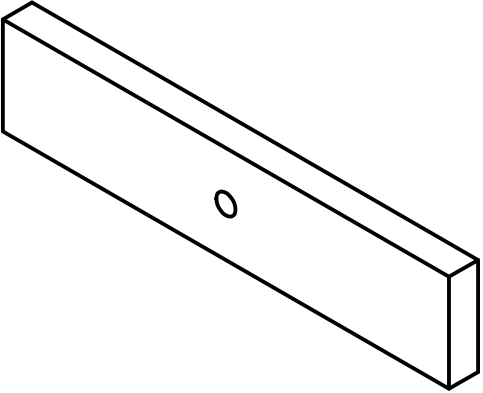

PROJECT BEE HONEY EXTRACTOR	CREATED BY A. PARDO	APPROVED BY		
PART NAME FRAME END	PART CODE 2.2	DOCUMENT TYPE PART	MATERIAL WOOD	
 OPEN SOURCE ECOLOGY GERMANY	LICENSE 	FILE NAME FRAME END.ipt	VERSION 1.0	QUANTITY 1
		SCALE 1 : 1	SHEET 16/23	DATE 29/9/2020



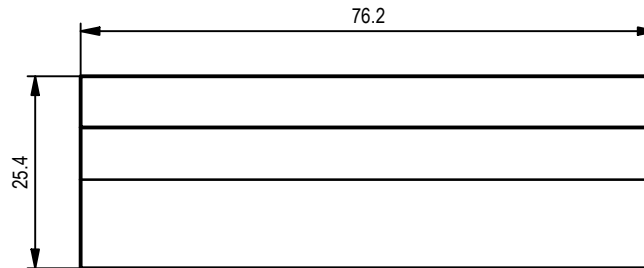
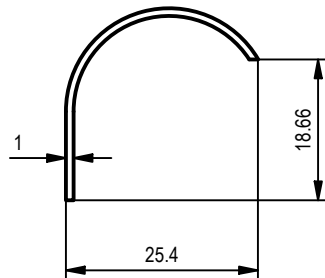
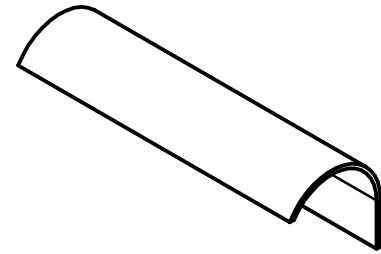

SECTION B-B
SCALE 1 : 2

PROJECT BEE HONEY EXTRACTOR		CREATED BY A. PARDO		APPROVED BY	
PART NAME CENTER BLOCK		PART CODE 2.3		DOCUMENT TYPE PART	
		LICENSE 		MATERIAL WOOD	
		FILE NAME CENTER BLOCK.ipt		VERSION 1.0	QUANTITY 1
		SCALE 1 : 2		SHEET 17/23	DATE 29/9/2020



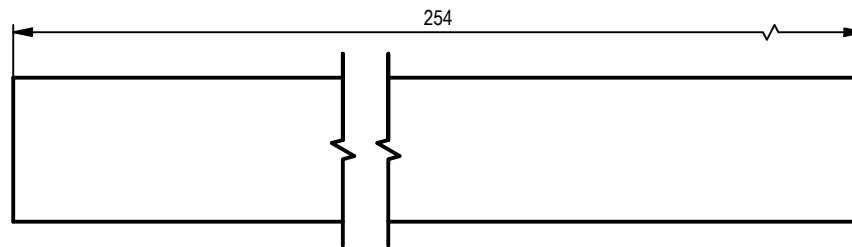
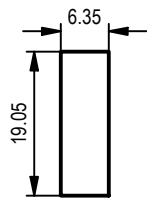
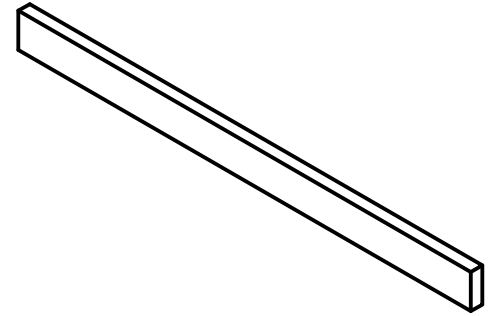

PROJECT BEE HONEY EXTRACTOR	CREATED BY A. PARDO	APPROVED BY		
PART NAME AIR DEFLECTOR	PART CODE 2.4	DOCUMENT TYPE PART	MATERIAL ALUMINUM	
 OPEN SOURCE ECOLOGY GERMANY	LICENSE 	FILE NAME AIR DEFLECTOR.ipt	VERSION 1.0	QUANTITY 1
		SCALE 1 : 1	SHEET 18/23	DATE 29/9/2020



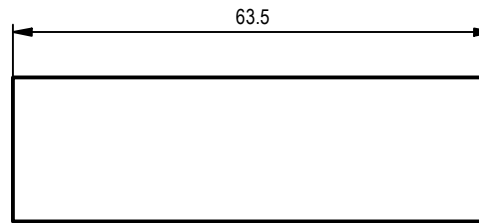
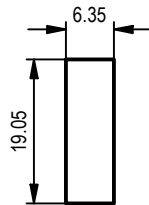
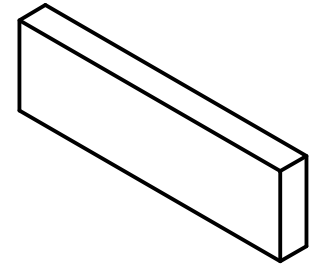

PROJECT BEE HONEY EXTRACTOR		CREATED BY A. PARDO		APPROVED BY	
PART NAME SCREEN STRIPS A		PART CODE 2.5		DOCUMENT TYPE PART	
		LICENSE 		MATERIAL WOOD	
		FILE NAME SCREEN STRIPS A.ipt		VERSION 1.0	QUANTITY 1
		SCALE 1 / 1		SHEET 19/23	DATE 29/9/2020



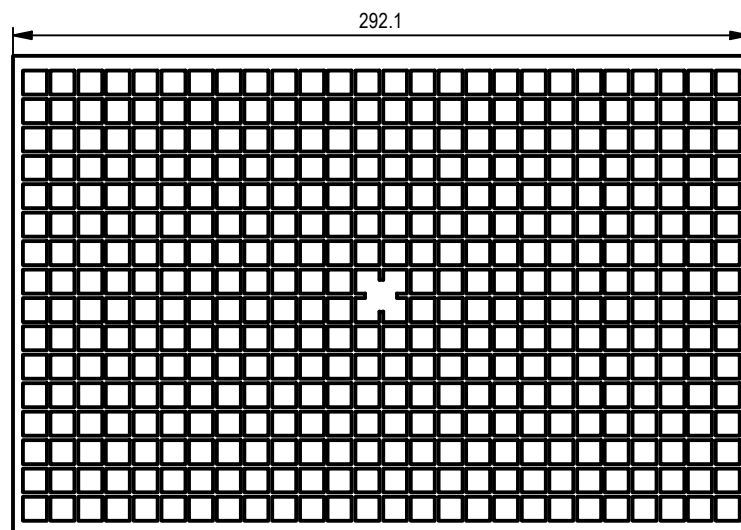
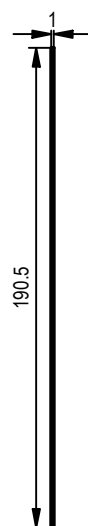
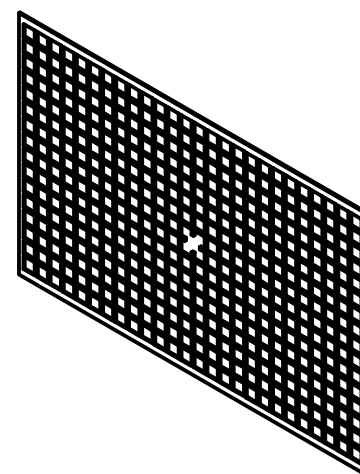

PROJECT BEE HONEY EXTRACTOR		CREATED BY A. PARDO		APPROVED BY	
PART NAME SCREEN STRIPS B		PART CODE 2.6		DOCUMENT TYPE PART	
 <small>OPEN SOURCE ECOLOGY GERMANY</small>		LICENSE 		MATERIAL WOOD	
		FILE NAME SCREEN STRIPS B.ipt		VERSION 1.0	QUANTITY 1
		SCALE 1 : 1		SHEET 20/23	DATE 29/9/2020



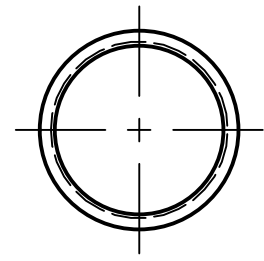
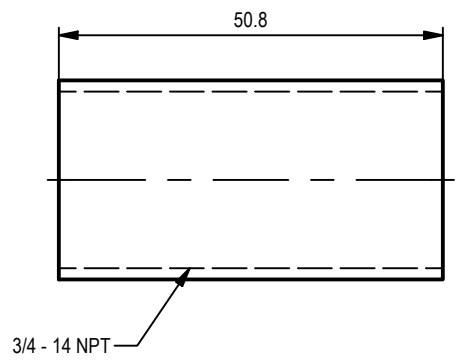
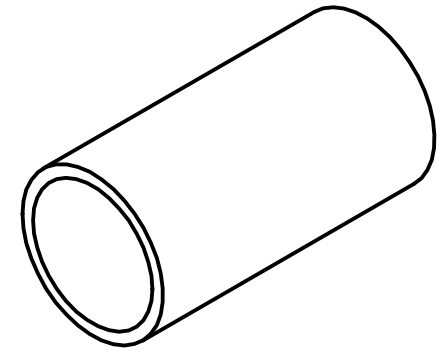

PROJECT BEE HONEY EXTRACTOR		CREATED BY A. PARDO		APPROVED BY	
PART NAME PLASTIC SCREEN		PART CODE 2.7		DOCUMENT TYPE PART	
		LICENSE 		MATERIAL PLIASTIC	
		FILE NAME PLASTIC SCREEN.ipt		VERSION 1.0	QUANTITY 1
		SCALE 1 / 3		SHEET 21/23	DATE 29/9/2020

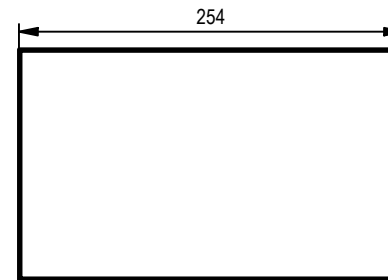
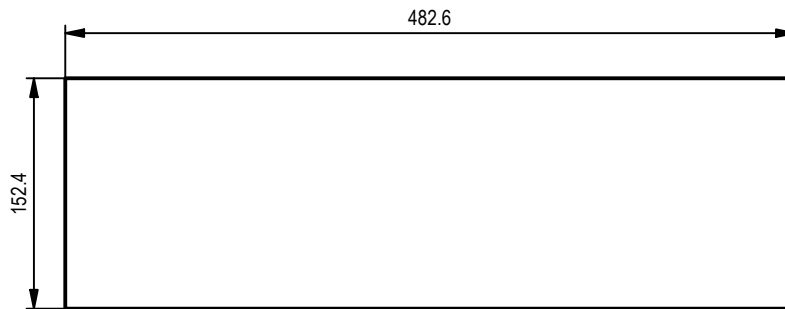
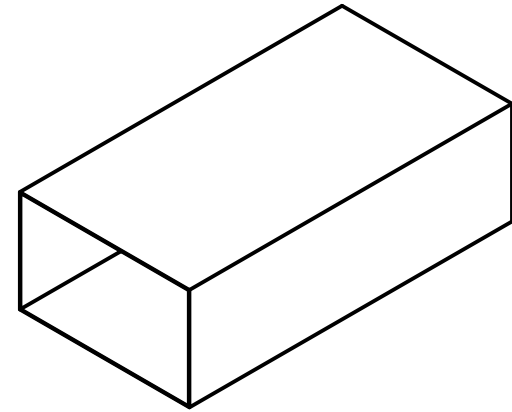

PROJECT BEE HONEY EXTRACTOR		CREATED BY A. PARDO		APPROVED BY	
PART NAME PIPE NIPLE		PART CODE 2.8		DOCUMENT TYPE PART	
		LICENSE 		MATERIAL STEEL METAL	
		FILE NAME PIPE NIPLE.ipt		VERSION 1.0	QUANTITY 1
		SCALE 1 : 1		SHEET 22/23	DATE 29/9/2020



PROJECT BEE HONEY EXTRACTOR	CREATED BY A. PARDO	APPROVED BY		
PART NAME PERF METAL	PART CODE 2.9	DOCUMENT TYPE PART	MATERIAL STEEL METAL	
 OPEN SOURCE ECOLOGY GERMANY	LICENSE 	FILE NAME PERF METAL.ipt	VERSION 1.0	QUANTITY 1
		SCALE 1 / 5	SHEET 23/23	DATE 29/9/2020