

PROJECT		CREATED BY	APPROVED BY	DATE	VERSION
Single Pan Balance		E. CEBALLOS	A. MORILLO	24-05-2021	1.0
PART NAME		FILE NAME			PART CODE
Single Pan Balance		apc_spb-single-pan-blance_1.01.iam			A1
DEVELOPED BY	REDESIGNED BY	SUPPORTED BY	DOC. TYPE	MATERIAL	QUANTITY
			ASSEMBLY		1
AMERICAN PEACE CORPS		OHO e.V.		LICENCE	SCALE
		CC-BY-SA 4.0			1 / 10

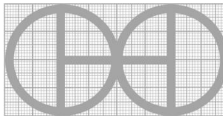
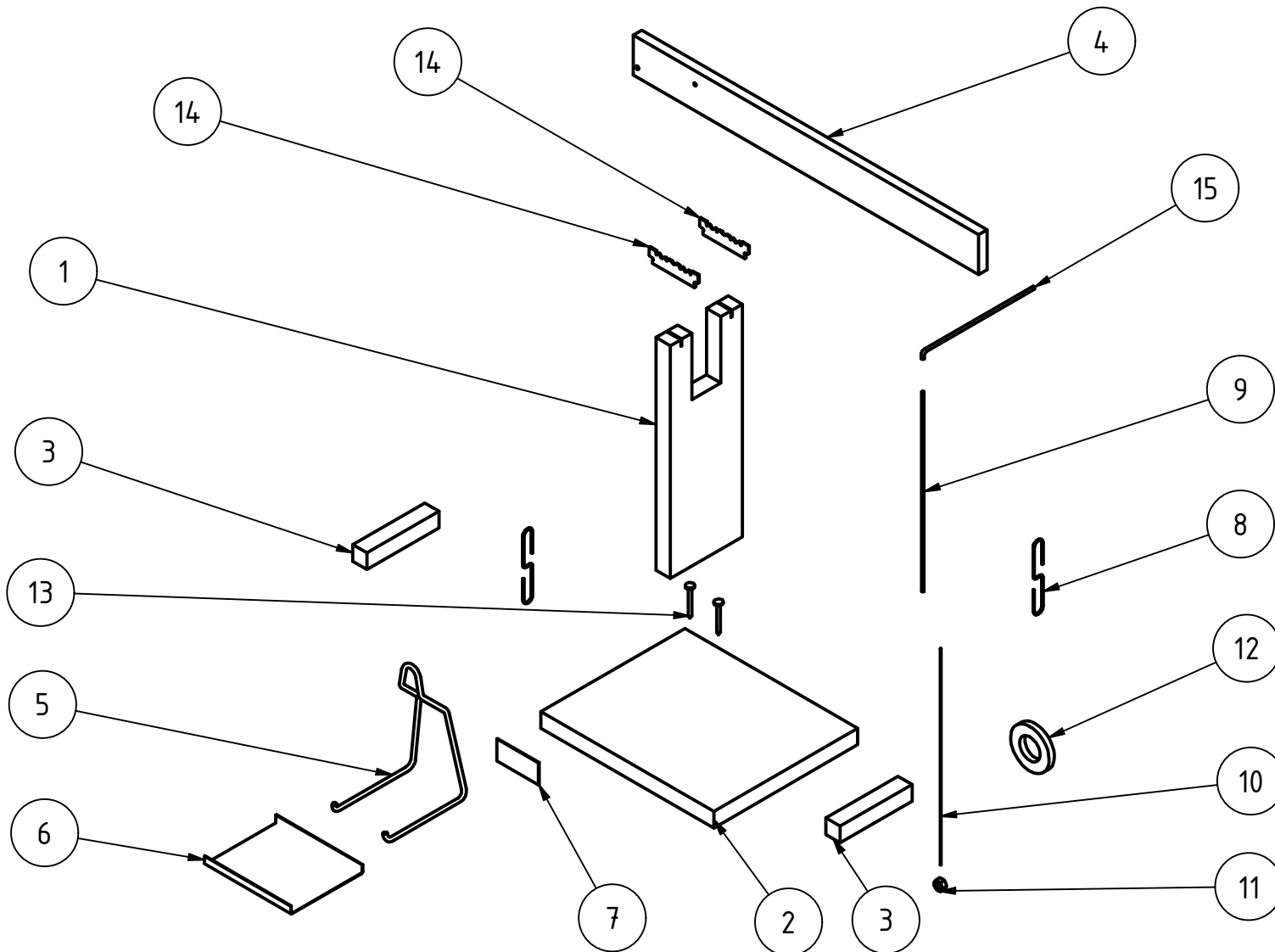
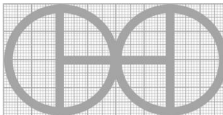
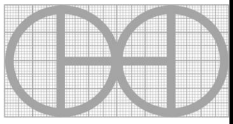

PROJECT		CREATED BY	APPROVED BY	DATE	VERSION
Single Pan Balance		E. CEBALLOS	A. MORILLO	24-05-2021	1.0
PART NAME		FILE NAME			PART CODE
Single Pan Balance		apc_spb-single-pan-balance_1.01.ipn			A2
DEVELOPED BY	REDESIGNED BY	SUPPORTED BY	DOC. TYPE	MATERIAL	QUANTITY
			ASSEMBLY		1
AMERICAN PEACE CORPS		OHO e.V.		LICENCE	SCALE
		CC-BY-SA 4.0			2 / 10

PART LIST							
POS	POS.OLD	QTY	PART NAME	FILE NAME	PART TYPE	SPECIFICATIONS	SHEET
A1			Single pan balance	apc:spb-single-pan-balnce_1.01iam			1
A2			Single pan balance	apc:spb-single-pan-balnce_1.01.ipn			2
B1			Part List				3
1		1	vertical support	vertical support.ipt	Production	Kiln-dried pine, thickness 1/2"	4
2		1	base board	base board.ipt	Production	Kiln-dried pine, thickness 1/2"	5
3		2	wooden support	wooden support.ipt	Production	Kiln-dried pine, thickness 1/2"	6
4		1	wooden ruler	wooden ruler.ipt	Production	Kiln-dried pine, thickness 1/2"	7
5		1	hook	hook.ipt	Production	Bicycle beam	8
6		1	saucer	saucer.ipt	Production	Steel, ASTM 1045 / DIN C45	9
7		1	carboard rule	cardboard rule.ipt	Production	paper	10
8		2	clip	clip.ipt	Standard	Steel, ASTM 1045 / DIN C45	
9		1	coarse broom straw	coarse broom straw.ipt	Standard	L = 17 cm	
10		1	string	string.ipt	Standard	L = 17 cm	
11		1	nut		Standard	ANSI B18.2.4.2M - M4x0,7	
12		1	washer		Standard	IFI 535 - 16	
13		4	nail	nail.ipt	Standard	1", Steel ASTM F-1667	
14		2	razor blade	razor blade.ipt	Standard	stainless steel	
15		1	bicycle pivot beam	bicycle beam.ipt	Standard	Bicycle beam	

PROJECT		CREATED BY	APPROVED BY	DATE	VERSION
Single Pan Balance		E. CEBALLOS	A. MORILLO	24-05-2021	1.0
PART NAME		FILE NAME			PART CODE
PART LIST					B1
DEVELOPED BY	REDESIGNED BY	SUPPORTED BY	DOC. TYPE	MATERIAL	QUANTITY
			PART LIST		
AMERICAN PEACE CORPS		OHO e.V.	LICENCE	SCALE	SHEET
			CC-BY-SA 4.0		3 / 10

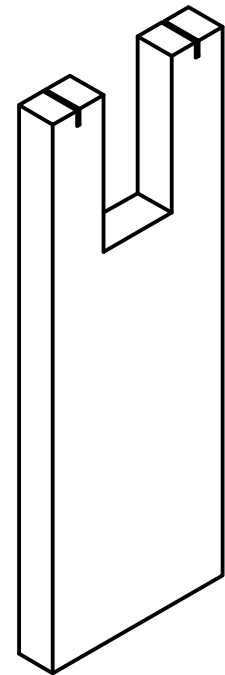
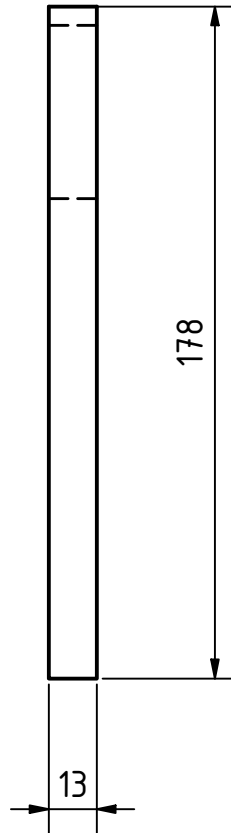
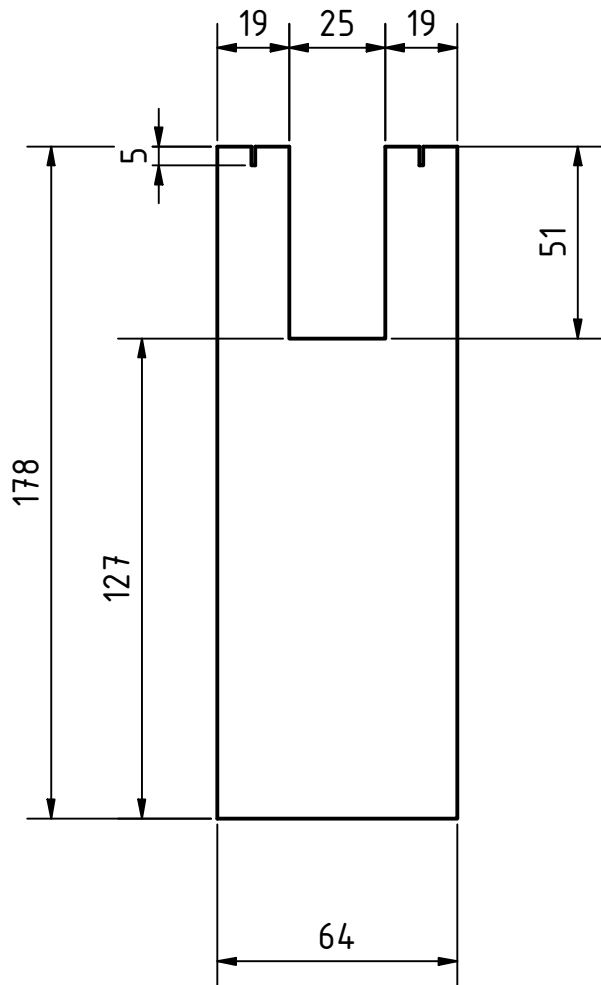

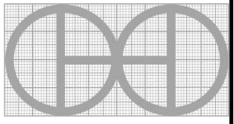
PROJECT		CREATED BY	APPROVED BY	DATE	VERSION
Single Pan Balance		E. CEBALLOS	A. MORILLO	24-05-2021	1.0
PART NAME		FILE NAME			PART CODE
vertical support		vertical support.ipt			1
DEVELOPED BY	REDESIGNED BY	SUPPORTED BY	DOC. TYPE	MATERIAL	QUANTITY
			PART	kiln-dried pine	1
AMERICAN PEACE CORPS		OHO e.V.	LICENCE	SCALE	SHEET
			CC-BY-SA 4.0	1:2	4 /10

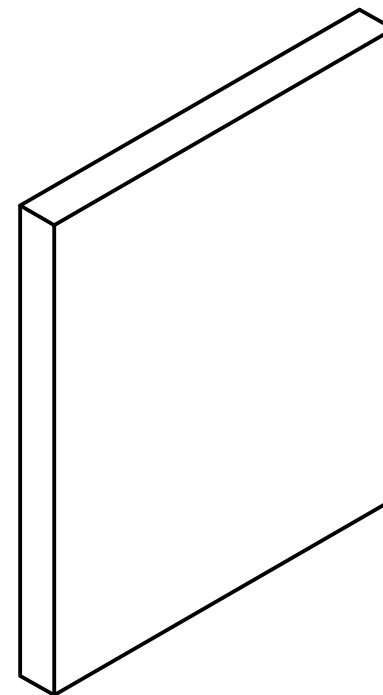
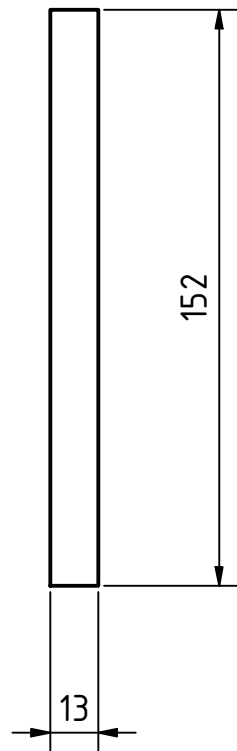
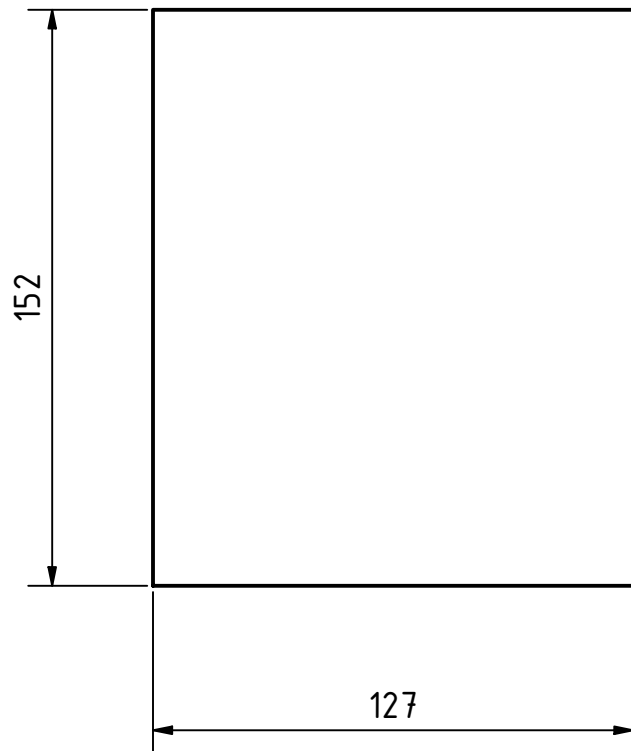

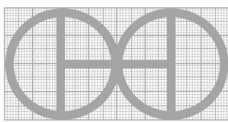
PROJECT		CREATED BY	APPROVED BY	DATE	VERSION
Single Pan Balance		E. CEBALLOS	A. MORILLO	24-05-2021	1.0
PART NAME		FILE NAME			PART CODE
base board		base board.ipt			2
DEVELOPED BY	REDESIGNED BY	SUPPORTED BY	DOC. TYPE	MATERIAL	QUANTITY
			PART	kiln-dried pine	1
AMERICAN PEACE CORPS		OHO e.V.	LICENCE	SCALE	SHEET
			CC-BY-SA 4.0	1:2	5 / 10

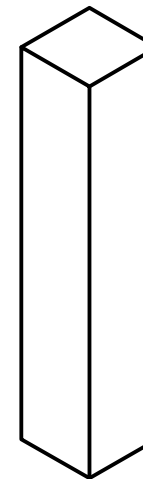
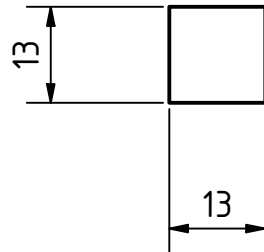
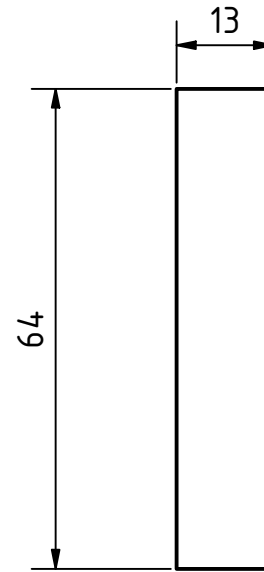
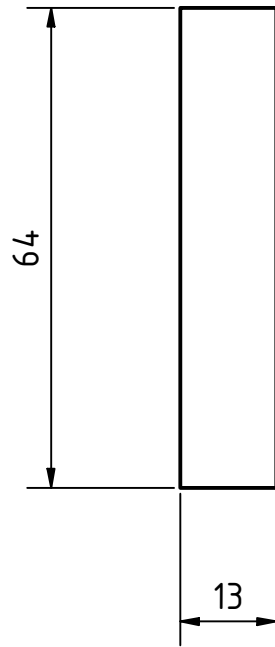

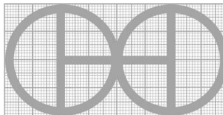
PROJECT		CREATED BY		APPROVED BY		DATE		VERSION	
Single Pan Balance		E. CEBALLOS		A. MORILLO		24-05-2021		1.0	
PART NAME				FILE NAME				PART CODE	
wooden support				wooden support.ipt				3	
DEVELOPED BY		REDESIGNED BY		SUPPORTED BY		DOC. TYPE	MATERIAL		QUANTITY
						PART	kiln-dried pine		2
						LICENCE		SCALE	SHEET
AMERICAN PEACE CORPS		OHO e.V.				CC-BY-SA 4.0		1:1	6 /10

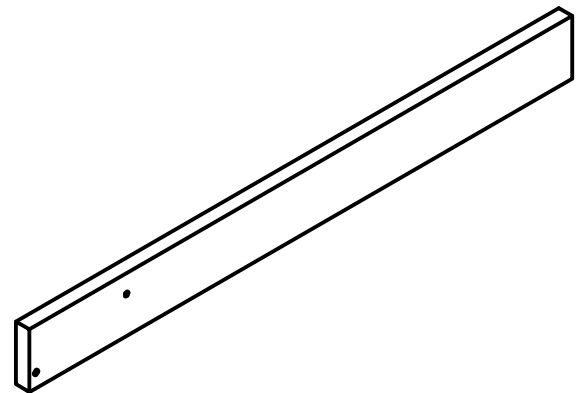
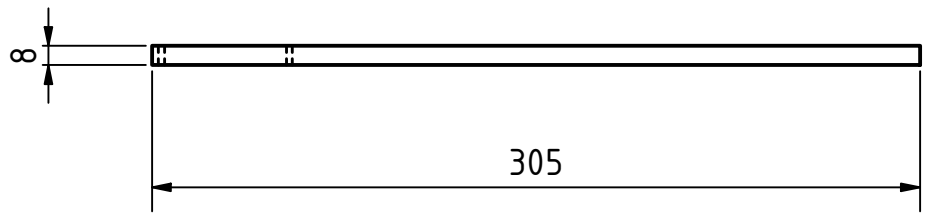
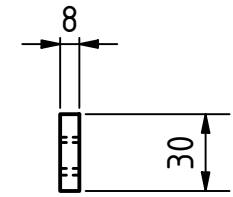
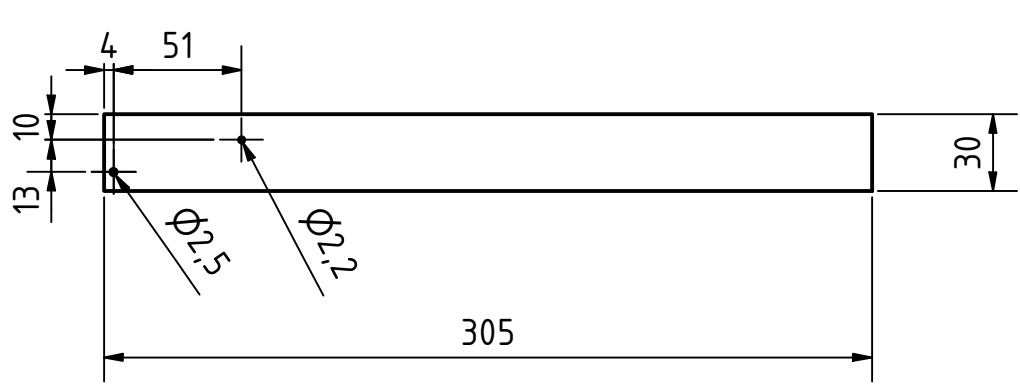

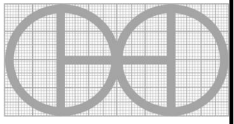
PROJECT		CREATED BY	APPROVED BY	DATE	VERSION
Single Pan Balance		E. CEBALLOS	A. MORILLO	24-05-2021	1.0
PART NAME		FILE NAME			PART CODE
wooden ruler		wooden ruler.ipt			4
DEVELOPED BY	REDESIGNED BY	SUPPORTED BY	DOC. TYPE	MATERIAL	QUANTITY
			PART	kiln-dried pine	1
AMERICAN PEACE CORPS		OHO e.V.		LICENCE	SHEET
		CC-BY-SA 4.0		SCALE	7 / 10
				1:3	

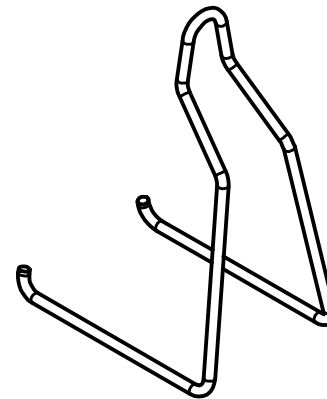
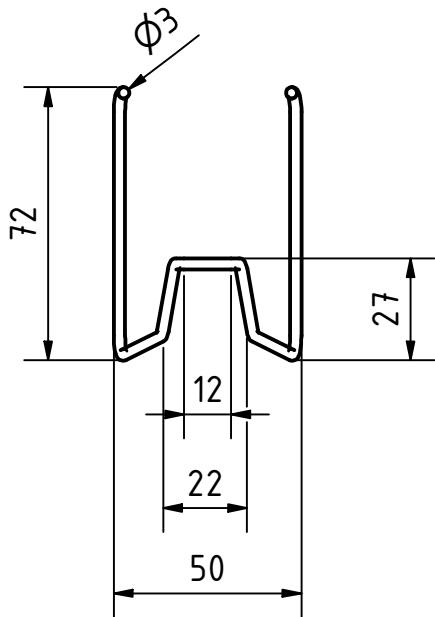
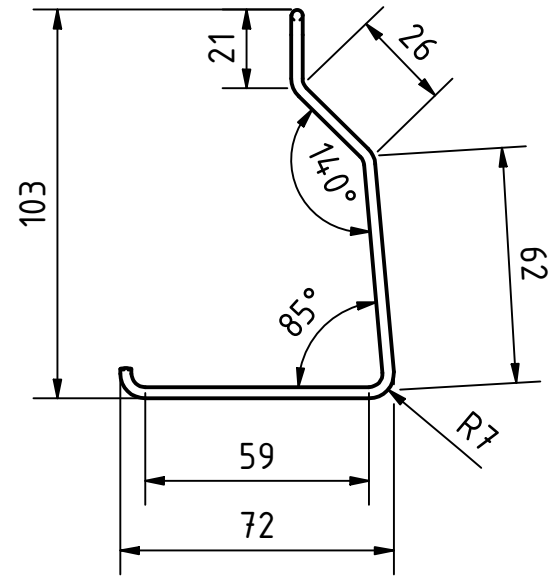
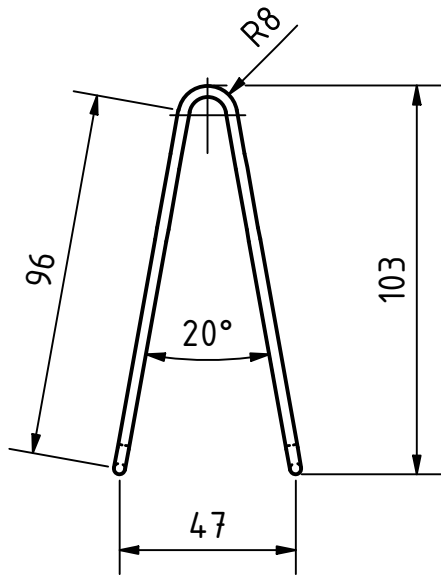

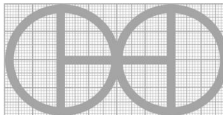
PROJECT		CREATED BY		APPROVED BY		DATE		VERSION	
Single Pan Balance		E. CEBALLOS		A. MORILLO		24-05-2021		1.0	
PART NAME		FILE NAME						PART CODE	
hook		hook.ipt						5	
DEVELOPED BY		REDESIGNED BY		SUPPORTED BY		DOC. TYPE	MATERIAL		QUANTITY
						PART	Bycycke Beam		1
AMERICAN PEACE CORPS		OHO e.V.				LICENCE	SCALE	SHEET	
						CC-BY-SA 4.0	1:2	8 /10	

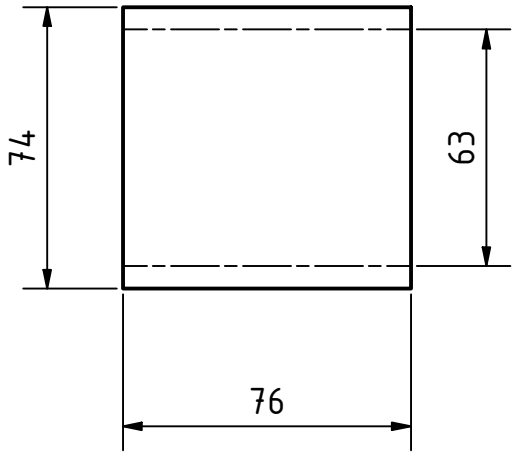

unfolded (1 : 2)

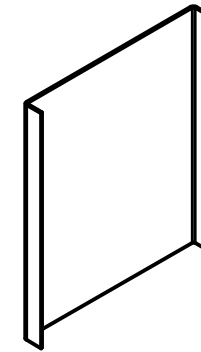
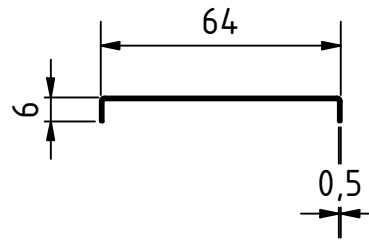
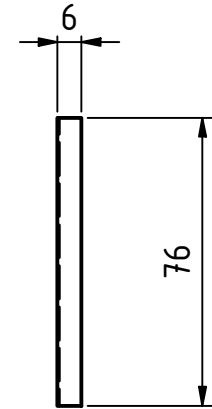
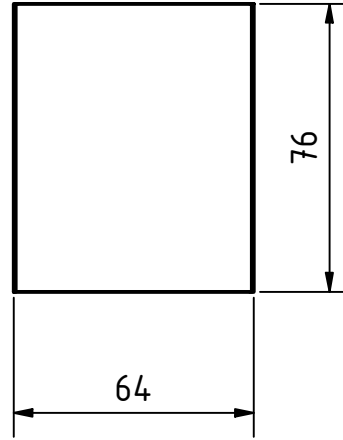

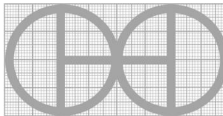
PROJECT		CREATED BY	APPROVED BY	DATE	VERSION
Single Pan Balance		E. CEBALLOS	A. MORILLO	24-05-2021	1.0
PART NAME		FILE NAME			PART CODE
source		source.ipt			6
DEVELOPED BY	REDESIGNED BY	SUPPORTED BY	DOC. TYPE	MATERIAL	QUANTITY
			PART	STEEL, ASTM 1045 / DIN C45	1
AMERICAN PEACE CORPS OHO e.V.			LICENCE	SCALE	SHEET
			CC-BY-SA 4.0	1:2	9 /10

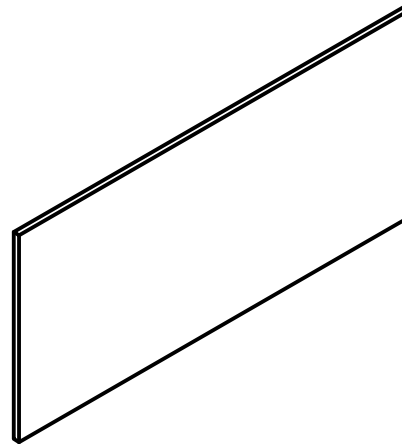
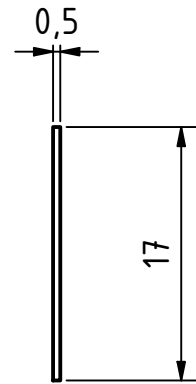
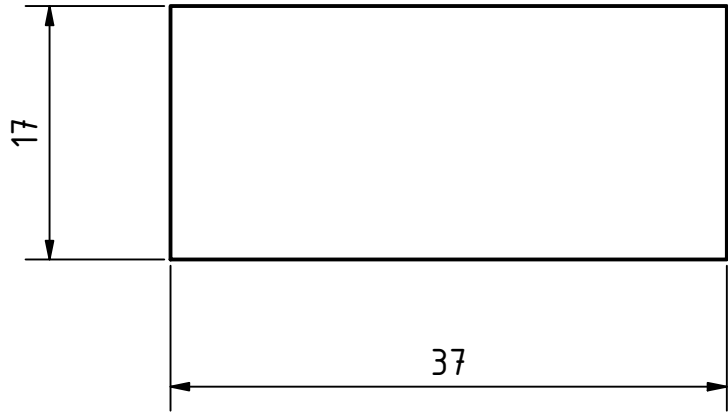

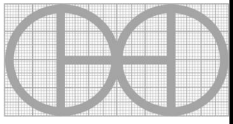
PROJECT		CREATED BY	APPROVED BY	DATE	VERSION
Single Pan Balance		E. CEBALLOS	A. MORILLO	24-05-2021	1.0
PART NAME		FILE NAME			PART CODE
cardboard rule		cardboard rule.ipt			7
DEVELOPED BY	REDESIGNED BY	SUPPORTED BY	DOC. TYPE	MATERIAL	QUANTITY
			PART	paper	1
AMERICAN PEACE CORPS		OHO e.V.	LICENCE	SCALE	SHEET
			CC-BY-SA 4.0	2:1	10 /10