

PROJEKT Nistkasten aus Holz und Metall fuer Kaninchen		ERSTELLT VON E. CEBALLOS	GENEHMIGT VON A. MORILLO	DATE 24-05-2021	VERSION 1.0
TEIL-NAME Wooden and metal nest box for rabbits		DATEI-NAME cvm_wmbr-wooden-metal-box-rabbits_1.01.iam			TEIL-CODE A1
ENTWICKELT VON Christian Veterinary Mission	UMGESTALTET VON  OHO e.V.	UNTERSTUETZT DURCH	DOK. TYP ASSEMBLY	WERKSTOFF	MENGE 1
			LIZENZ CC-BY-SA 4.0	SCALE 1:8	SEITE 1 / 9

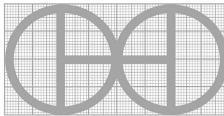
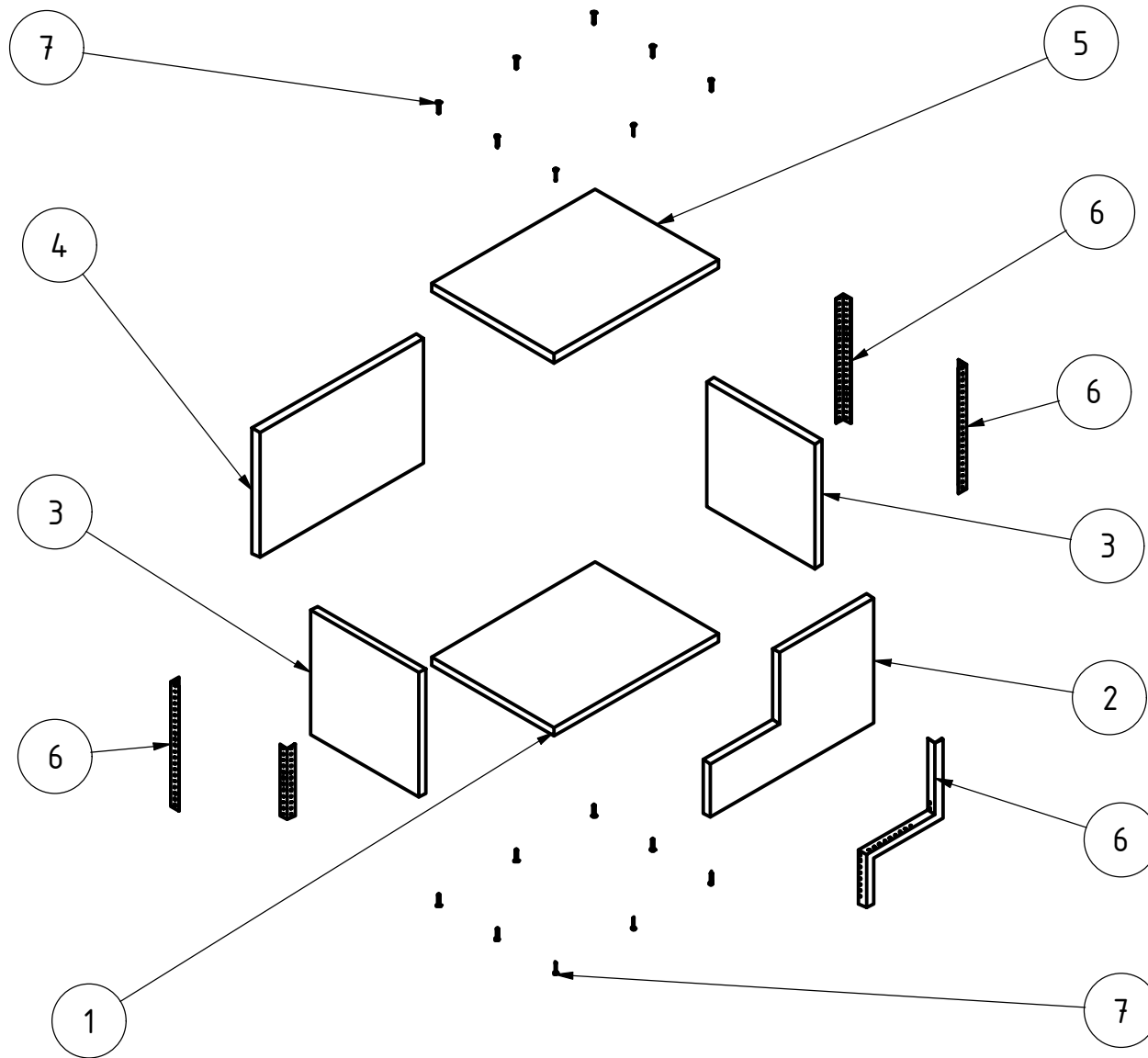

PROJEKT Nistkasten aus Holz und Metall fuer Kaninchen		ERSTELLT VON E. CEBALLOS	GENEHMIGT VON A. MORILLO	DATE 24-05-2021	VERSION 1.0
TEIL-NAME wooden metal box rabbits		DATEI-NAME cvm_wmbr-wooden-metal-box-rabbits_1.01.ipn			TEIL-CODE A2
ENTWICKELT VON Christian Veterinary Mission	UMGESTALTET VON OHO e.V.	UNTERSTUETZT DURCH	DOK. TYP ASSEMBLY	WERKSTOFF	MENGE 1
		LIZENZ CC-BY-SA 4.0	SCALE 1:12	SEITE 2 / 9	

PARTS LIST

POS	QTY	TEIL NAME	DATEI-NAME	TEIL-TYP	SPEZIFIKATIONEN	SEITE
A		3D-Ansichten	cvm_wmbr-wooden-metal-box-rabbits_1.01.iam			1-feb
B		Teileliste				3
1	1	Grundplatte	base board.ipt	Production	Im Ofen getrocknetes Holz, Dicke 18 mm	4
2	1	Vordere Platte	front board.ipt	Production	Kiln-getrocknetes Holz, Dicke 18mm	5
3	2	Seitliche Platine	side board.ipt	Production	Kiln-getrocknetes Holz, Dicke 18mm	6
4	1	Rückwand	back board.ipt	Production	Kiln-getrocknetes Holz, Dicke 18mm	7
5	1	Obere Platte	upper board.ipt	Production	Kiln-getrocknetes Holz, Dicke 18mm	8
6	4	Metallrahmen	Metal frame.ipt	Production	Kiln-getrocknetes Holz, Dicke 18mm	9
7	18	Schrauben ISO 7050		Standard	Schrauben ISO 7050 - ST3,5 x 25 - C -H	

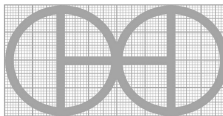
PROJEKT Nistkasten aus Holz und Metall fuer Kaninchen		ERSTELLT VON E. CEBALLOS	GENEHMIGT VON A. MORILLO	DATE 24-05-2021	VERSION 1.0
TEIL-NAME Teileliste		DATEI-NAME			TEIL-CODE B
ENTWICKELT VON Christian Veterinary Mission	UMGESTALTET VON  OHO e.V.	UNTERSTUETZT DURCH	DOK. TYP PART LIST	WERKSTOFF	MENGE
		LIZENZ CC-BY-SA 4.0		SCALE	SEITE 3 / 9

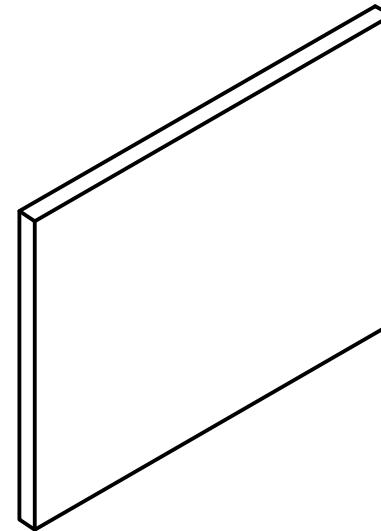
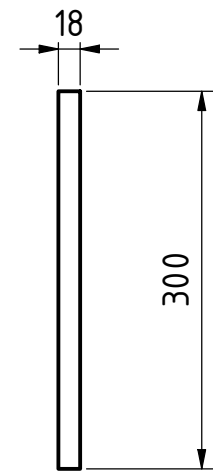
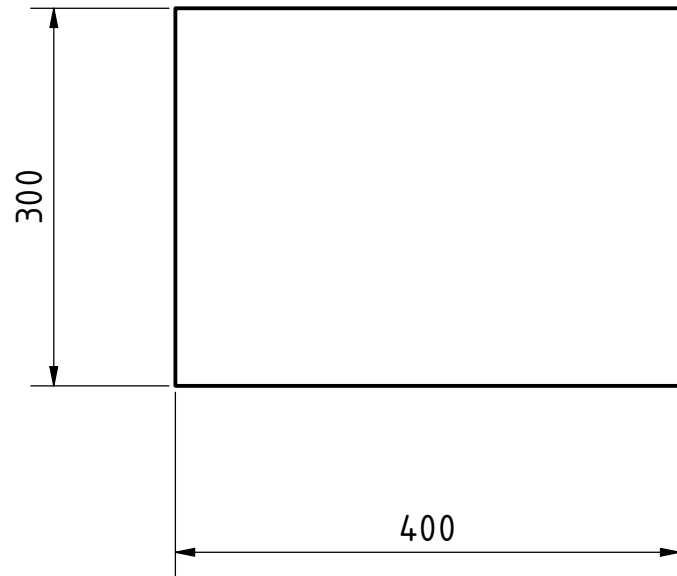

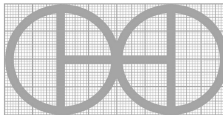
PROJEKT Nistkasten aus Holz und Metall fuer Kaninchen		ERSTELLT VON E. CEBALLOS	GENEHMIGT VON A. MORILLO	DATE 24-05-2021	VERSION 1.0
TEIL-NAME Grundplatte		DATEI-NAME base board.ipt			TEIL-CODE 1
ENTWICKELT VON Christian Veterinary Mission	UMGESTALTET VON  OHO e.V.	UNTERSTUETZT DURCH	DOK. TYP PART	WERKSTOFF Im Ofen getrocknetes Holz	MENGE 1
			LIZENZ CC-BY-SA 4.0	SCALE 1:6	SEITE 4 / 9

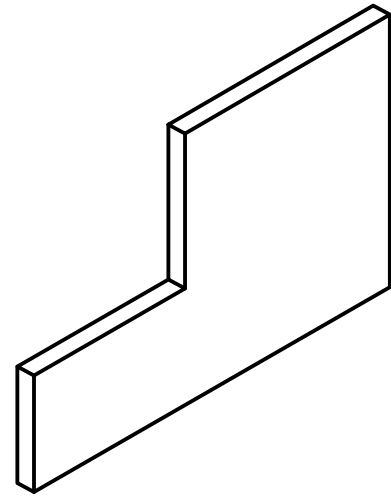
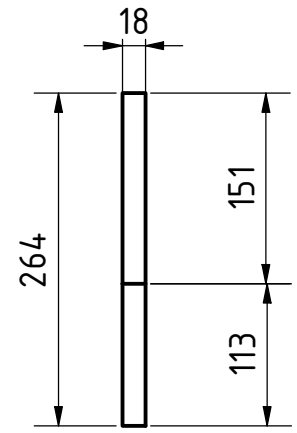
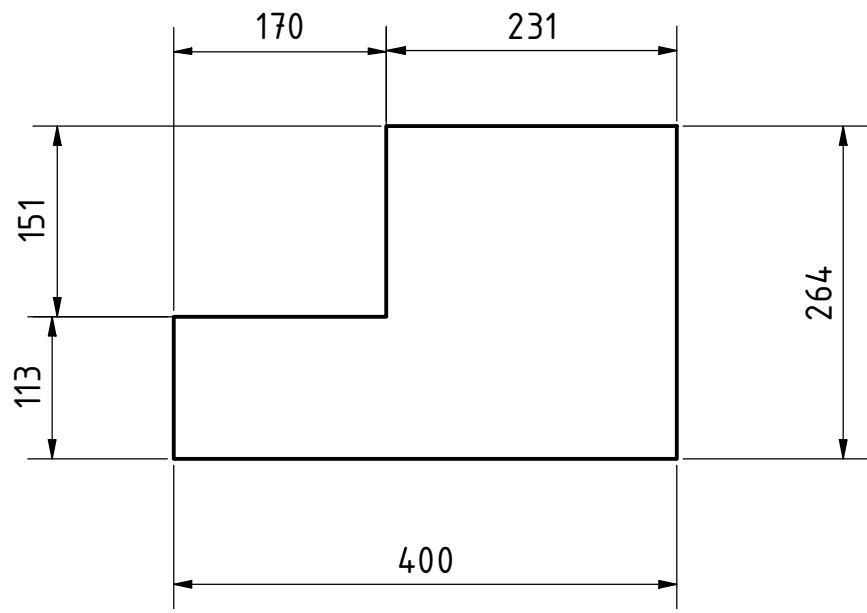

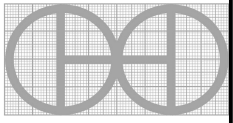
PROJEKT Nistkasten aus Holz und Metall fuer Kaninchen		ERSTELLT VON E. CEBALLOS	GENEHMIGT VON A. MORILLO	DATE 24-05-2021	VERSION 1.0
TEIL-NAME Vordere Platte		DATEI-NAME front board.ipt			TEIL-CODE 2
ENTWICKELT VON Christian Veterinary Mission	UMGESTALTET VON  OHO e.V.	UNTERSTUEZT DURCH	DOK. TYP PART	WERKSTOFF Kiln-getrocknetes Holz	MENGE 1
			LIZENZ CC-BY-SA 4.0	SCALE 1:6	SEITE 5 / 9

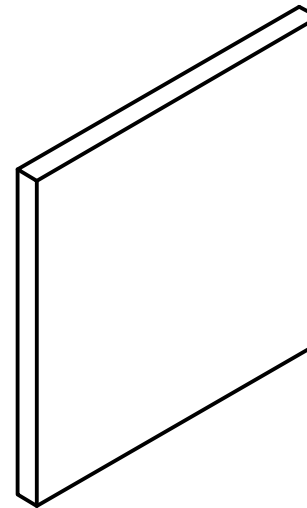
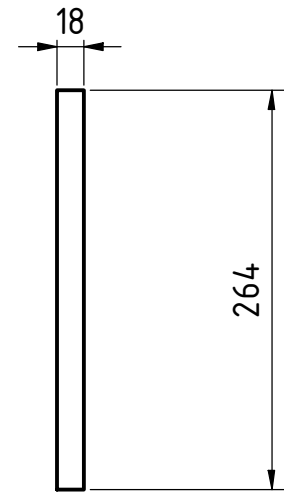
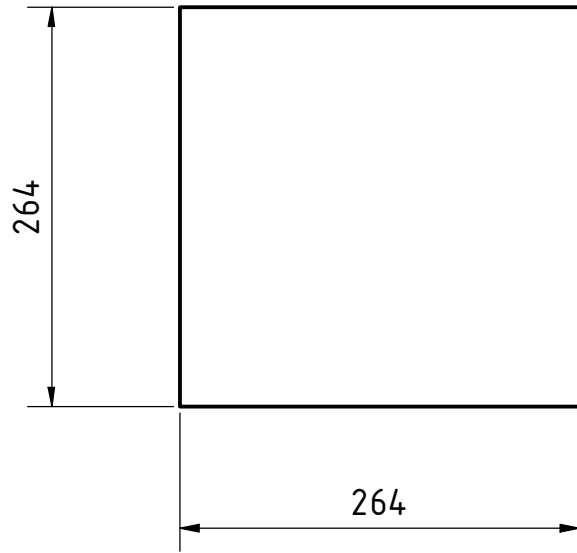

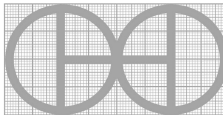
PROJEKT Nistkasten aus Holz und Metall fuer Kaninchen		ERSTELLT VON E. CEBALLOS	GENEHMIGT VON A. MORILLO	DATE 24-05-2021	VERSION 1.0
TEIL-NAME Seitliche Platine		DATEI-NAME side board.ipt			TEIL-CODE 3
ENTWICKELT VON	UMGESTALTET VON	UNTERSTUETZT DURCH	DOK. TYP	WERKSTOFF	MENGE
Christian Veterinary Mission	 OHO e.V.		PART	Kiln-getrocknetes Holz	2
			LIZENZ	SCALE	SEITE
		CC-BY-SA 4.0	1:5	6 / 9	

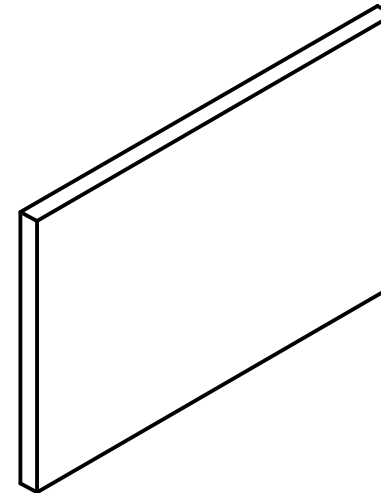
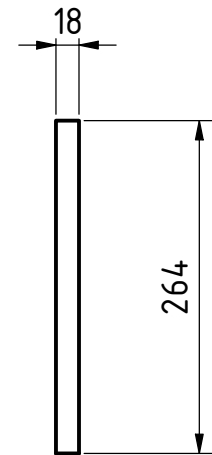
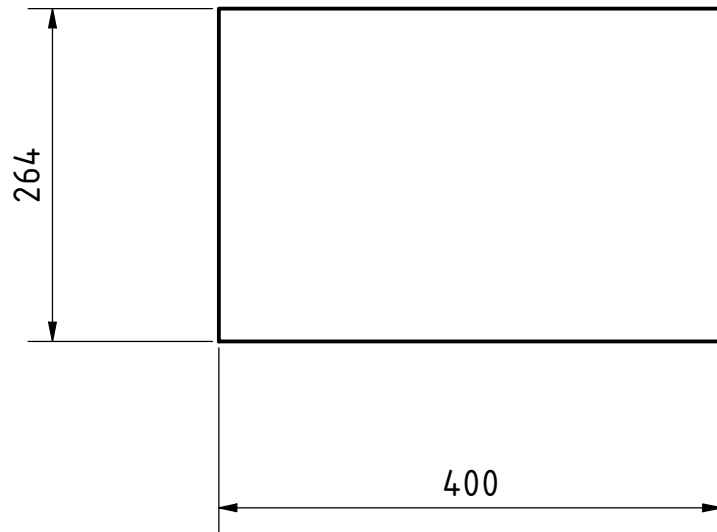

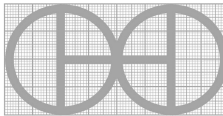
PROJEKT Nistkasten aus Holz und Metall fuer Kaninchen		ERSTELLT VON E. CEBALLOS	GENEHMIGT VON A. MORILLO	DATE 24-05-2021	VERSION 1.0
TEIL-NAME Rückwand		DATEI-NAME back board.ipt			TEIL-CODE 4
ENTWICKELT VON Christian Veterinary Mission	UMGESTALTET VON  OHO e.V.	UNTERSTUETZT DURCH	DOK. TYP PART	WERKSTOFF Kiln-getrocknetes Holz	MENGE 1
			LIZENZ CC-BY-SA 4.0	SCALE 1:6	SEITE 7 / 9

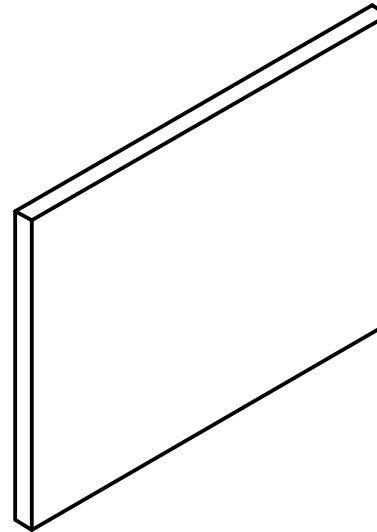
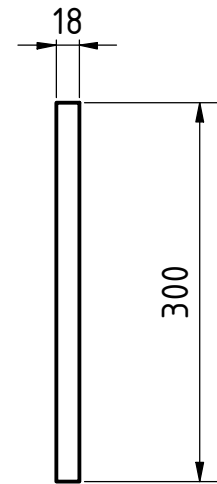
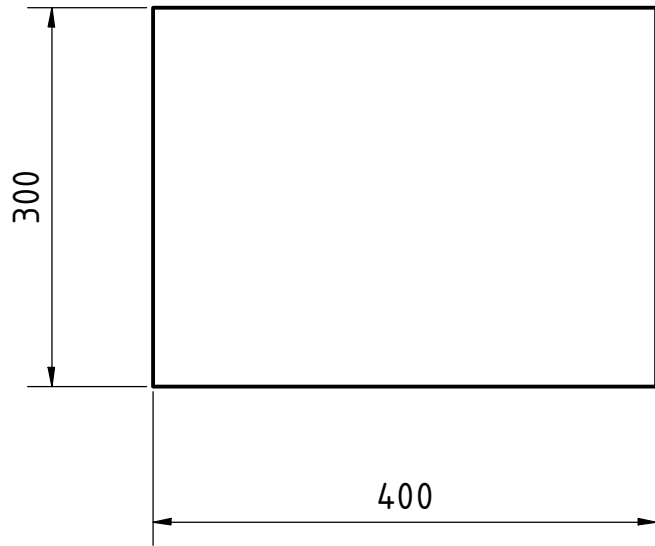

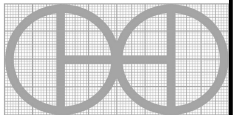
PROJEKT Nistkasten aus Holz und Metall fuer Kaninchen		ERSTELLT VON E. CEBALLOS	GENEHMIGT VON A. MORILLO	DATE 24-05-2021	VERSION 1.0
TEIL-NAME Obere Platte		DATEI-NAME upper board.ipt			TEIL-CODE 5
ENTWICKELT VON Christian Veterinary Mission	UMGESTALTET VON  OHO e.V.	UNTERSTUETZT DURCH	DOK. TYP PART	WERKSTOFF Kiln-getrocknetes Holz	MENGE 1
			LIZENZ CC-BY-SA 4.0	SCALE 1:6	SEITE 8 / 9

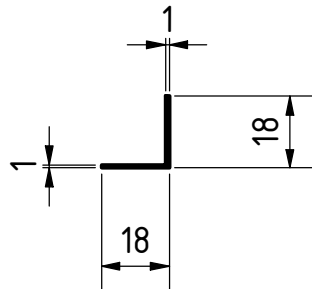
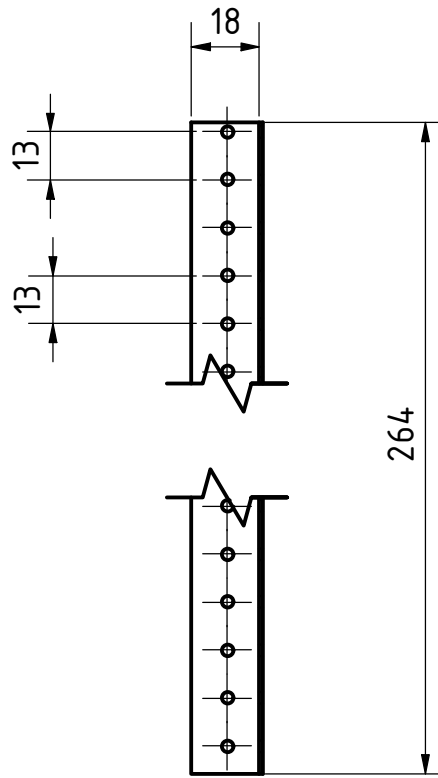
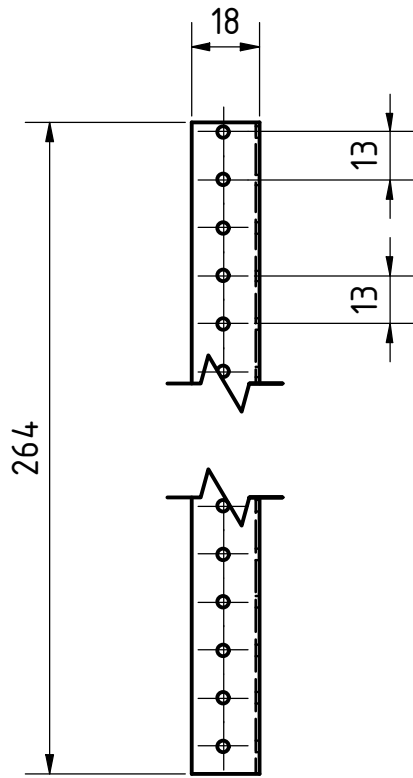

PROJEKT Nistkasten aus Holz und Metall fuer Kaninchen		ERSTELLT VON E. CEBALLOS	GENEHMIGT VON A. MORILLO	DATE 24-05-2021	VERSION 1.0
TEIL-NAME Metallrahmen		DATEI-NAME Metal frame.ipt			TEIL-CODE 6
ENTWICKELT VON Christian Veterinary Mission	UMGESTALTET VON OHO e.V.	UNTERSTUETZT DURCH	DOK. TYP PART	WERKSTOFF Kiln-getrocknetes Holz	MENGE 4
		LIZENZ CC-BY-SA 4.0		SCALE 1:2	SEITE 9 / 9