

B (1 : 15)

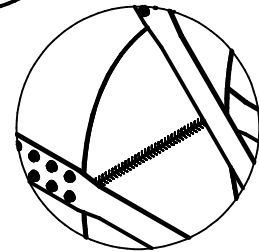

C (1 : 15)

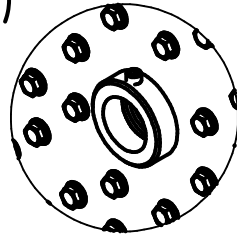

A (1 : 5)

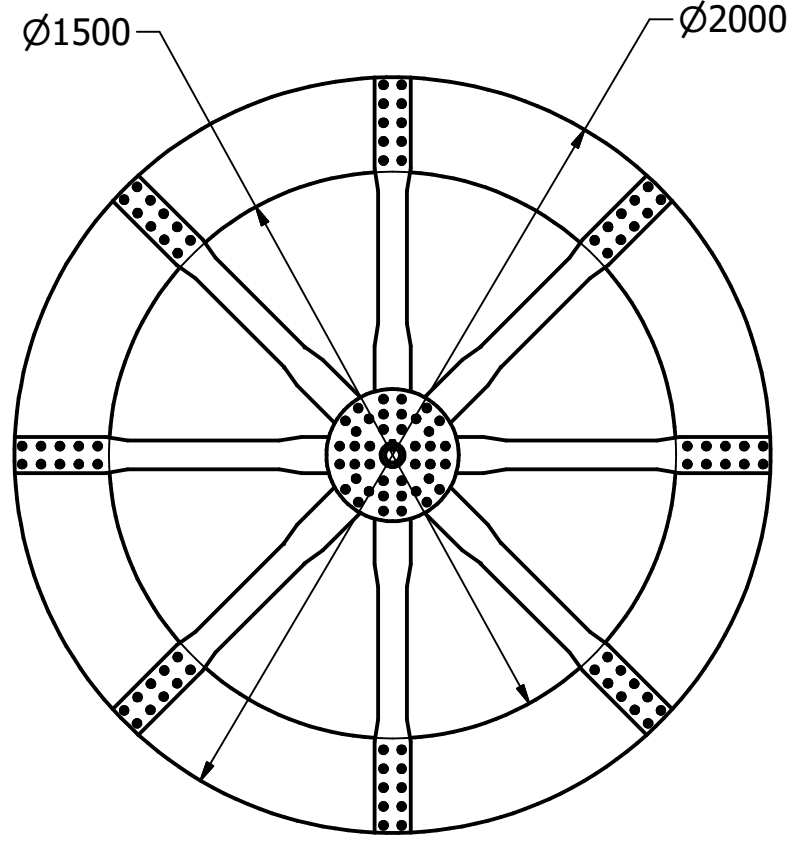
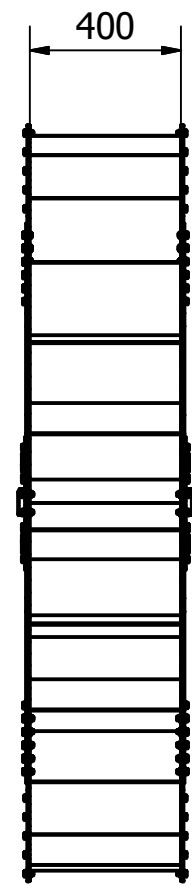

PROJECT	CREATED BY	APPROVED BY	DATE	VERSION
Water wheel diameter 2m	J. ROSCIANO	A. MORILLO	01/12/2021	1.0
PART NAME	FILE NAME			POS
Wheel assembly	Wheel assembly.iam			1.0
DEVELOPED BY	REDESIGNED BY	DOC. TYPE	MATERIAL	QUANTITY
Henry Walker - Youtube	 OPEN SOURCE ECOLOGY GERMANY	OHO e.V. Assembly		1
		LICENCE	SCALE	SHEET
		CC-BY-SA 4.0		7 /31

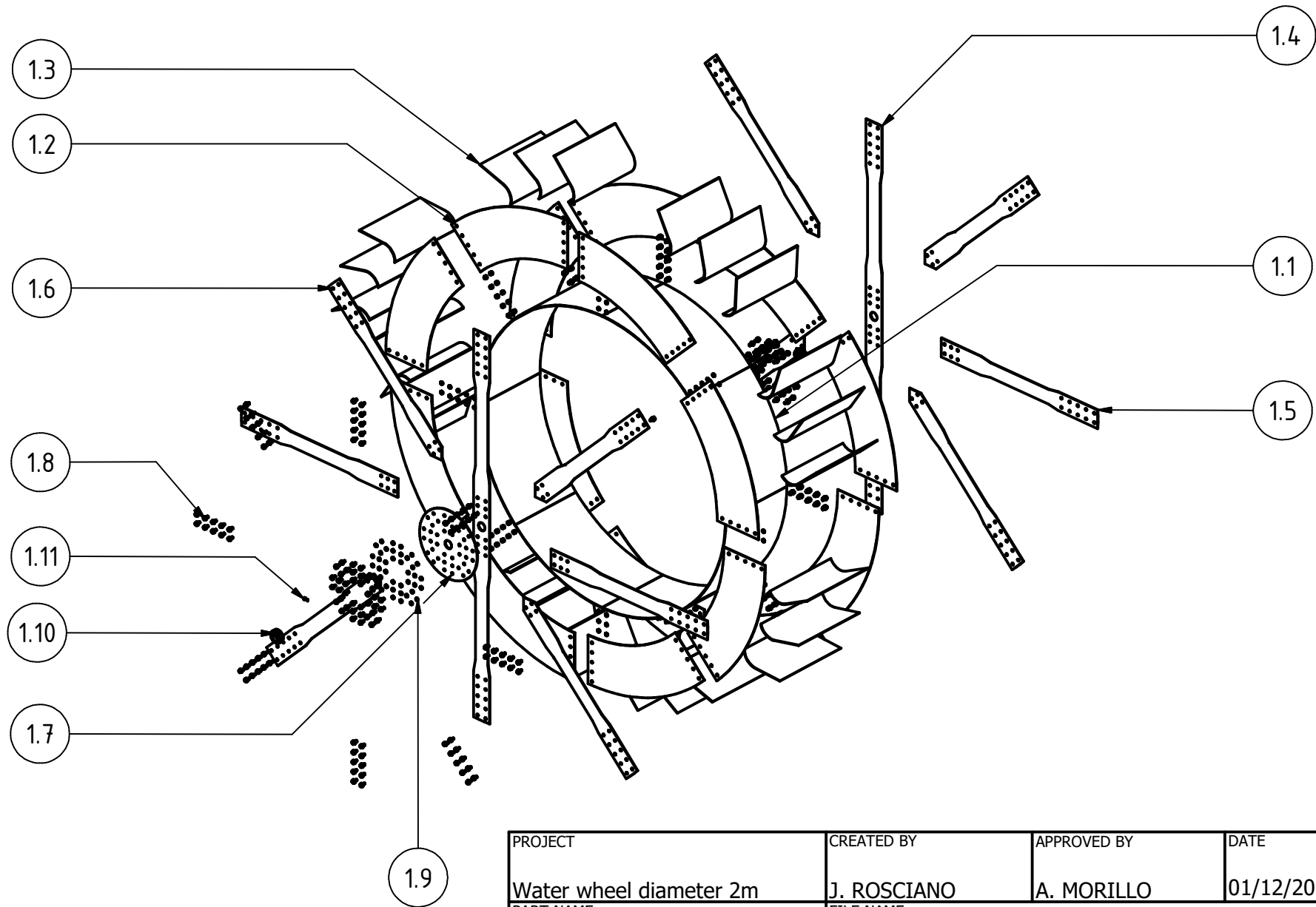

PROJECT	CREATED BY	APPROVED BY	DATE	VERSION
Water wheel diameter 2m	J. ROSCIANO	A. MORILLO	01/12/2021	1.0
PART NAME	FILE NAME			POS
Wheel assembly	Wheel assembly.iam			1.0
DEVELOPED BY	REDESIGNED BY	DOC. TYPE	MATERIAL	QUANTITY
	 OPEN SOURCE ECOLOGY GERMANY	OHO e.V. Assembly		1
Henry Walker - Youtube		LICENCE	SCALE	SHEET
		CC-BY-SA 4.0		8 /31