

# ELEVATION ( 1 :20 )

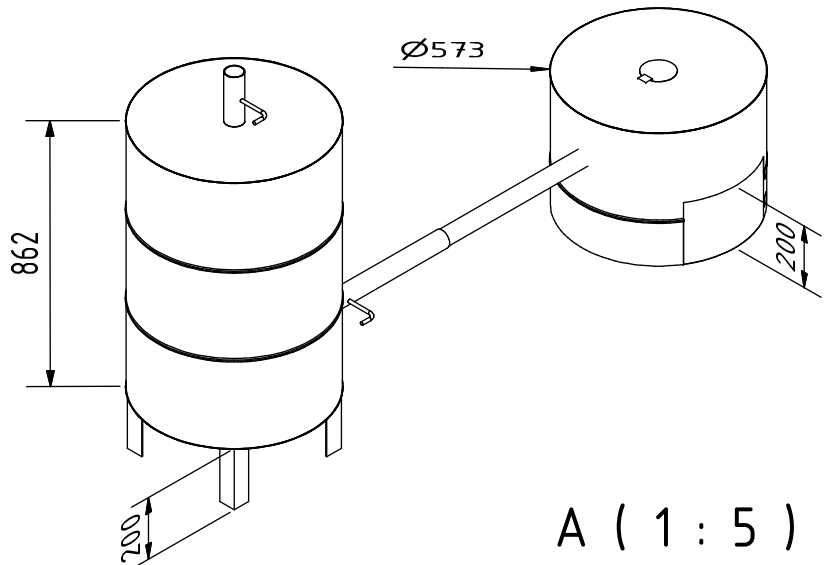

A ( 1 : 5 )

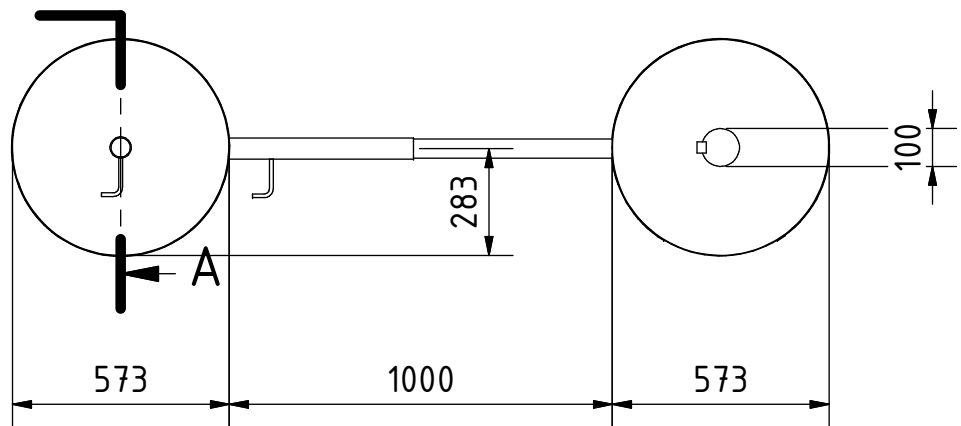
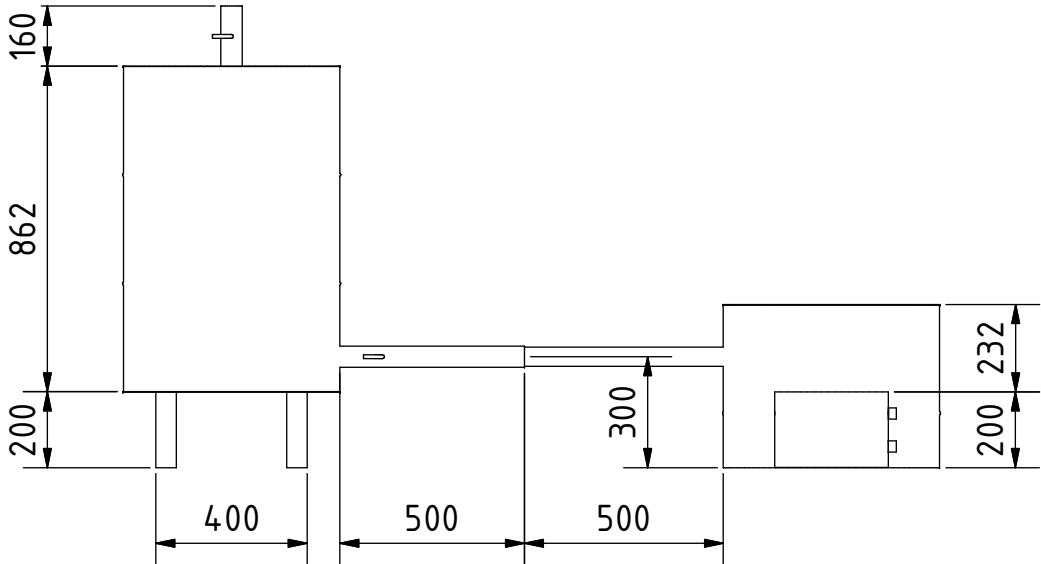

A-A ( 1 :20 )

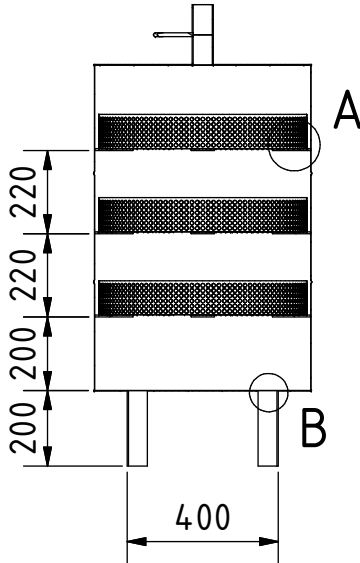

A ( 1 : 5 )

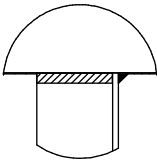

Note: all units are in mm

PROJEKT	ERSTELLT VON	GENEHMIGT VON	DATE	VERSION
Fischtrockner Raeucherei	J. Zeron	A. Morillo	08-06-2021	1.0
TEIL-NAME	DATEI-NAME			TEIL-CODE
3d Ansichten	ilo_dfds_dum-fish-dryer-smoker.iam			A1
ENTWICKELT VON	UMGESTALET VON	DOK. TYP	WERKSTOFF	MENGE
		ASSEMBLY		1
INTERNATIONAL LABOUR OFFICE	OHO e.V.	LIZENZ	SCALE	SEITE
		CC-BY-SA 4.0	1:20	1 /17

# EXPLOSION ( 1 : 15 )

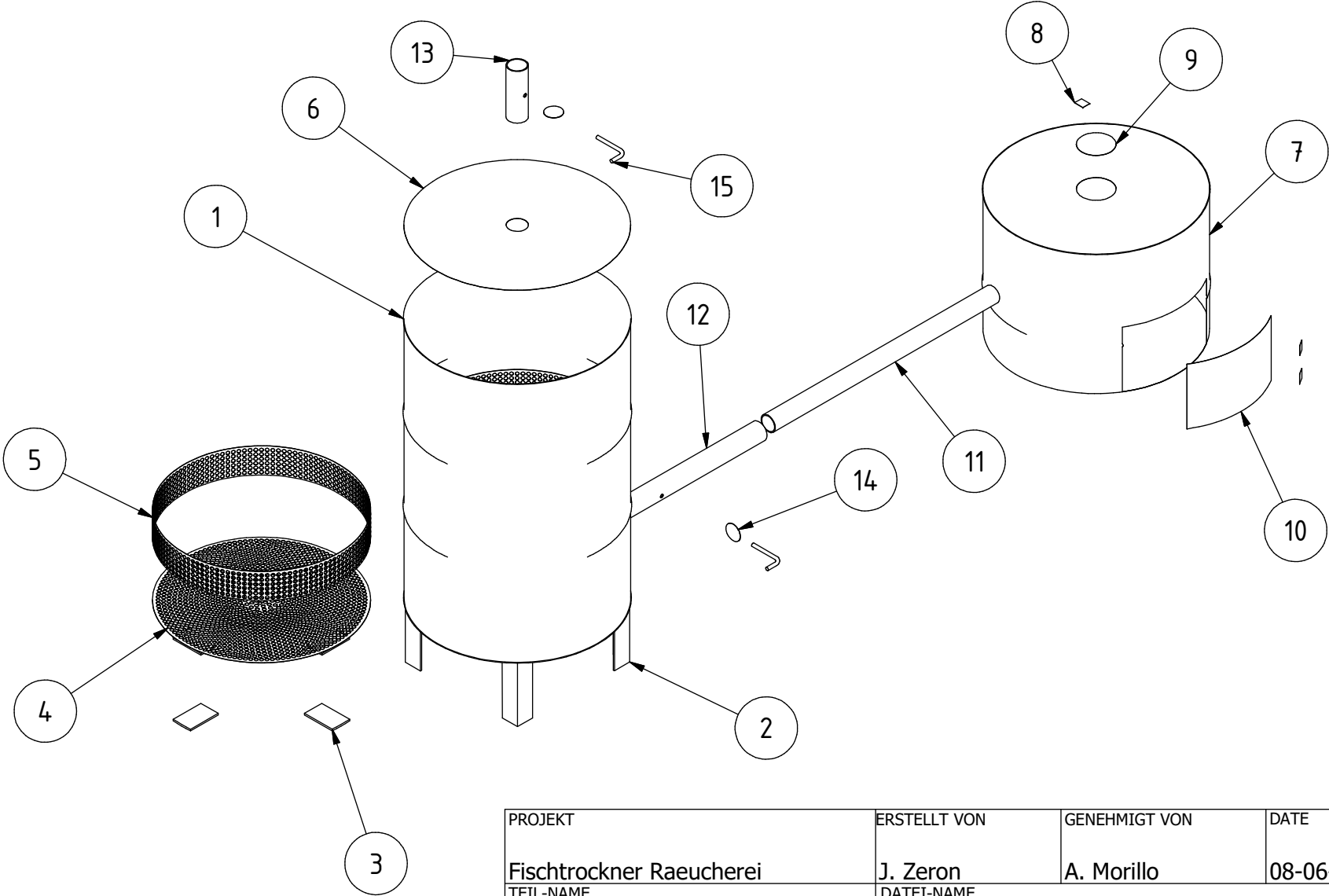

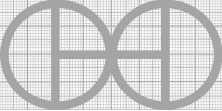
PROJEKT	ERSTELLT VON	GENEHMIGT VON	DATE	VERSION
Fischtrockner Raeucherei	J. Zeron	A. Morillo	08-06-2021	1.0
TEIL-NAME	DATEI-NAME			TEIL-CODE
3d-Explosionszeichnungen	ilo_dfds_dum-fish-dryer-smoker.ipn			A2
ENTWICKELT VON	UMGESTALET VON	DOK. TYP	WERKSTOFF	MENGE
		ASSEMBLY		1
INTERNATIONAL LABOUR OFFICE	OHO e.V.	LIZENZ	SCALE	SEITE
		CC-BY-SA 4.0	1:15	2 / 17

PART LIST

POS	QTY	TEIL NAME	DETEI-NAME	TEIL-TYP	SPEZIFIKATIONEN	SEITE
A1	-	3D Ansichten	manual-fuel-briquette-press.iam	ASSEMBLY	-	1
A2	-	3d-Explosionszeichnun gen	ilo_dfds_dum-fish-dryer-smoker.ipn	ASSEMBLY	-	2
B1	-	Teileliste	ilo_dfds_dum-fish-dryer-smoker.csv	-	-	3
1	1	Rauchertrommel	Smoker drum.ipt	Production	Gewalzter stahl	4
2	4	Pfote	Foot.ipt	Production	Winkel aus kohlenstoffstahl 50x50x4 mm klasse A42 L=20 cm	5
3	12	Tablettboden	Tray base.ipt	Production	Plate aus kohlenstoffstahl 2" PS-25	6
4	3	Fach A	Tray A.ipt	Production	Perforiertes metall, dicke 1-2 mm	7
5	3	Fach B	Tray B.ipt	Production	Perforiertes metall, dicke 1-2 mm	8
6	1	Deckel	Lid.ipt	Production	Metallfassschrott	9
7	1	Feuertrommel	Fire drum.ipt	Production	Metallfassschrott	10
8	3	Scharnier	-	Buy	Messing 1", genietet	-
9	1	Obere duse	Upper nozzle.ipt	Production	Metallfassschrott	11
10	1	Seiteneingang	Side entrance.ipt	Production	Metallfassschrott	12
11	1	Rohr A	Tube A.ipt	Production	2" schwarzes eisen L=80cm	13
12	1	Rohr B	Tube B.ipt	Production	2 1/4" schwarzes eisen L=50cm	14
13	1	Rohr C	Tube C.ipt	Production	2 1/4" schwarzes eisen L=16cm	15
14	2	Duse	Nozzle.ipt	Production	Blech	16
15	2	Bar	Bar.ipt	Production	Flachstange 3/8"	17

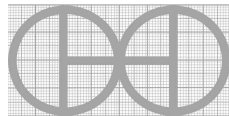
PROJEKT		ERSTELLT VON	GENEHMIGT VON	DATE	VERSION
Fischtrockner Raeucherei		J. Zeron	A. Morillo	08-06-2021	1.0
TEIL-NAME		DATEI-NAME			TEIL-CODE
Teileliste		ilo_dfds_dum-fish-dryer-smoker.csv			B1
ENTWICKELT VON		UMGESTALET VON		DOK. TYP	WERKSTOFF
				PART LIST	
INTERNATIONAL LABOUR OFFICE		OHO e.V.		LIZENZ	SCALE
				CC-BY-SA 4.0	SEITE
					3 / 17

# ELEVATION ( 1 : 15 )

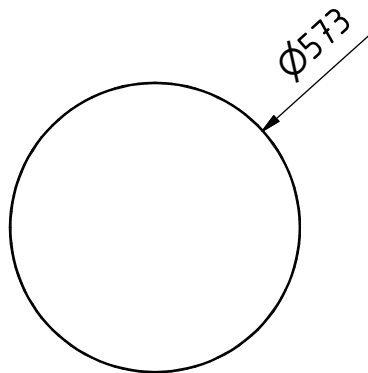
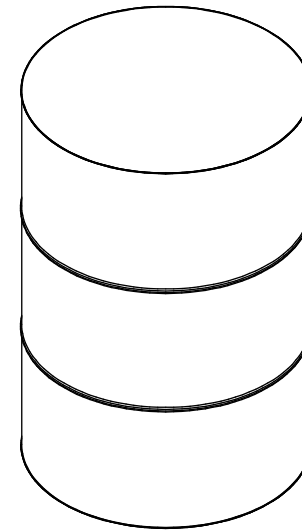
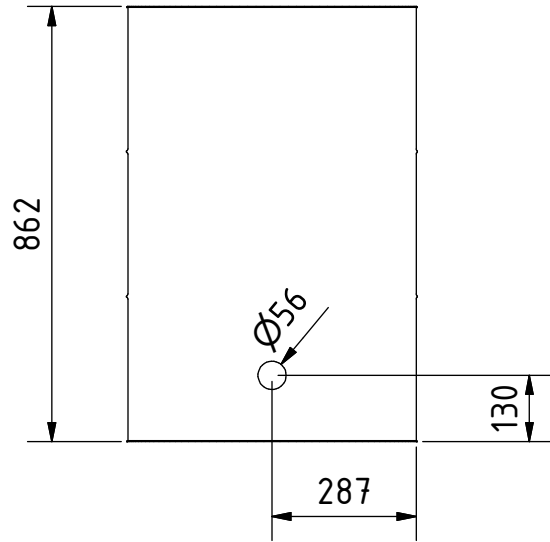

Note: all units are in mm

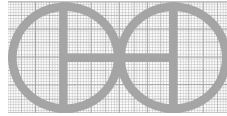
PROJEKT	ERSTELLT VON	GENEHMIGT VON	DATE	VERSION
Fischtrockner Raeucherei	J. Zeron	A. Morillo	08-06-2021	1.0
TEIL-NAME	DATEI-NAME			TEIL-CODE
Rauchertrommel	Smoker Drum.ipt			1
ENTWICKELT VON	UMGESTALET VON	DOK. TYP	WERKSTOFF	MENGE
		PART	Gewalzter stahl	1
INTERNATIONAL LABOUR OFFICE	OHO e.V.	LIZENZ	SCALE	SEITE
		CC-BY-SA 4.0	1:13	4 / 17

# ELEVATION ( 1 : 3 )

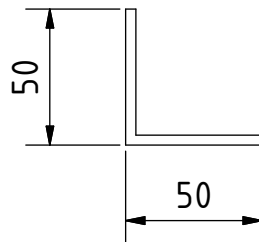
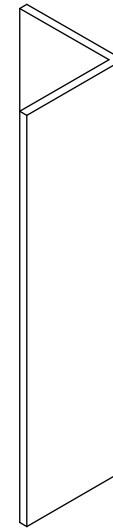
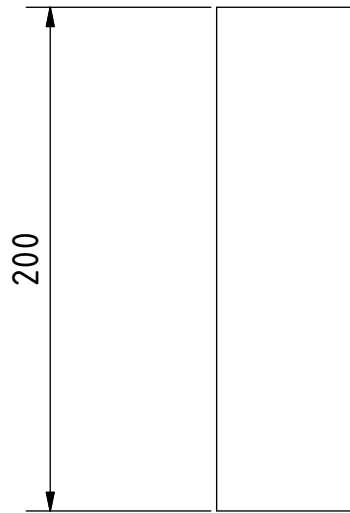

Note: all units are in mm

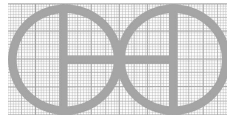
PROJEKT	ERSTELLT VON	GENEHMIGT VON	DATE	VERSION
Fischtrockner Raeucherei	J. Zeron	A. Morillo	08-06-2021	1.0
TEIL-NAME	DATEI-NAME			TEIL-CODE
Pfote	Foot.ipt			2
ENTWICKELT VON	UMGESTALET VON	DOK. TYP	WERKSTOFF	MENGE
		PART	Kohlenstoffahl	4
INTERNATIONAL LABOUR OFFICE	OHO e.V.	LIZENZ	SCALE	SEITE
		CC-BY-SA 4.0	1:3	5 /17

# PLAN ( 1 : 2 )

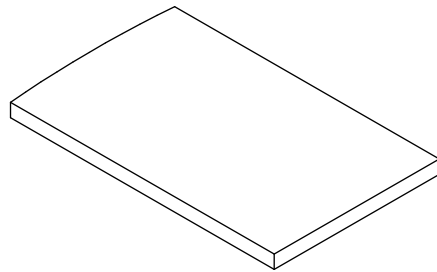
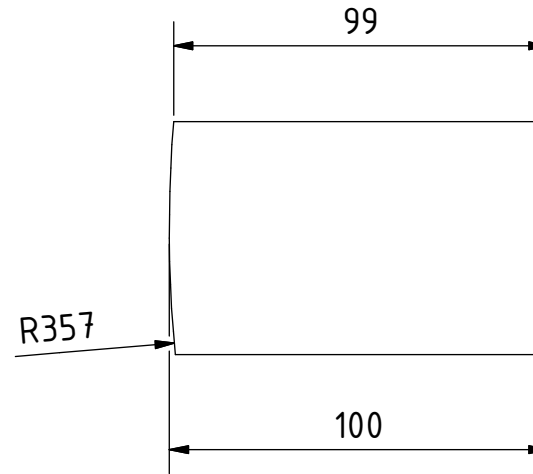
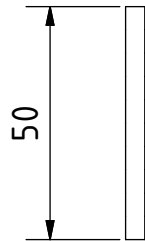

Note: all units are in mm

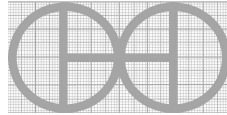
PROJEKT	ERSTELLT VON	GENEHMIGT VON	DATE	VERSION
Fischtrockner Raeucherei	J. Zeron	A. Morillo	08-06-2021	1.0
TEIL-NAME	DATEI-NAME			TEIL-CODE
Tablettboden	Tray Base.ipt			3
ENTWICKELT VON	UMGESTALET VON	DOK. TYP	WERKSTOFF	MENGE
		PART	Kohlenstofftahl	12
INTERNATIONAL LABOUR OFFICE	OHO e.V.	LIZENZ	SCALE	SEITE
		CC-BY-SA 4.0	1:2	6 /17

# PLAN ( 1 : 8 )

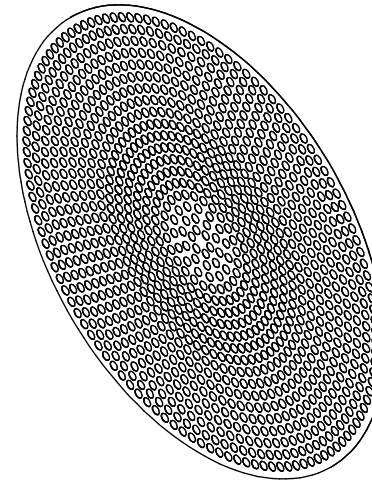
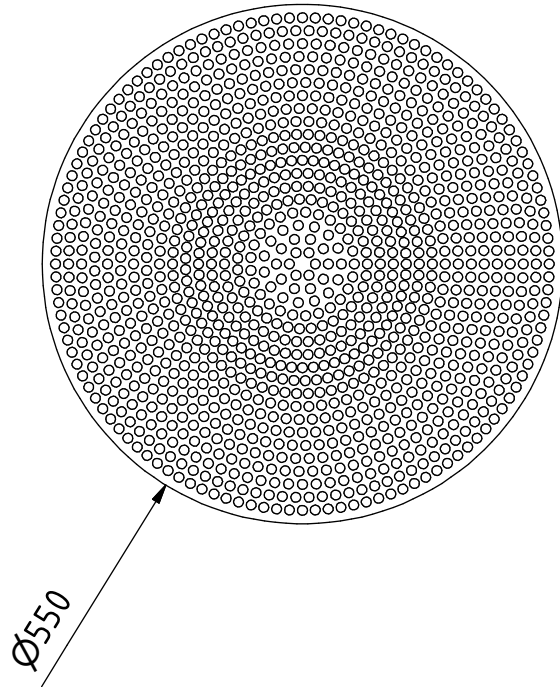

Note: all units are in mm

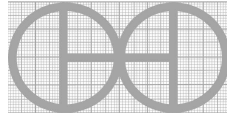
PROJEKT	ERSTELLT VON	GENEHMIGT VON	DATE	VERSION
Fischtrockner Raeucherei	J. Zeron	A. Morillo	08-06-2021	1.0
TEIL-NAME	DATEI-NAME			TEIL-CODE
Fach A	Tray A.ipt			4
ENTWICKELT VON	UMGESTALET VON	DOK. TYP	WERKSTOFF	MENGE
		PART	Perforiertes metall	3
INTERNATIONAL LABOUR OFFICE	OHO e.V.	LIZENZ	SCALE	SEITE
		CC-BY-SA 4.0	1:8	7 /17

PLAN ( 1 : 8 )

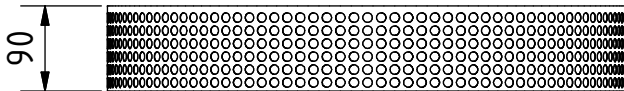
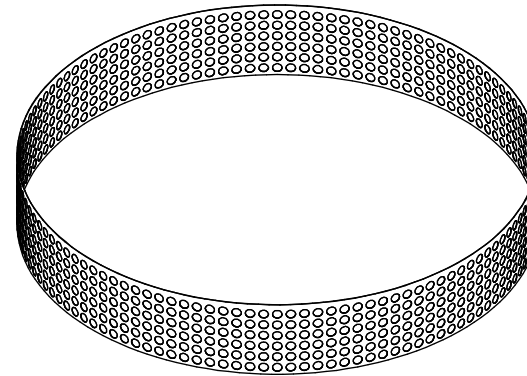
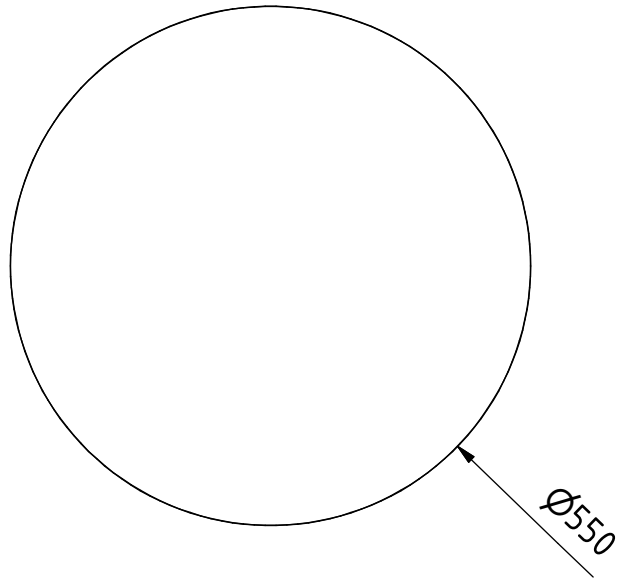

Note: all units are in mm

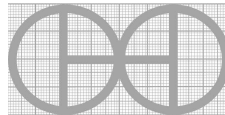
PROJEKT	ERSTELLT VON	GENEHMIGT VON	DATE	VERSION
Fischtrockner Raeucherei	J. Zeron	A. Morillo	08-06-2021	1.0
TEIL-NAME	DATEI-NAME			TEIL-CODE
Fach B	Tray B.ipt			5
ENTWICKELT VON	UMGESTALET VON	DOK. TYP	WERKSTOFF	MENGE
		PART	Perforiertes metall	3
INTERNATIONAL LABOUR OFFICE	OHO e.V.	LIZENZ	SCALE	SEITE
		CC-BY-SA 4.0	1:8	8 / 17



# PLAN ( 1 : 8 )

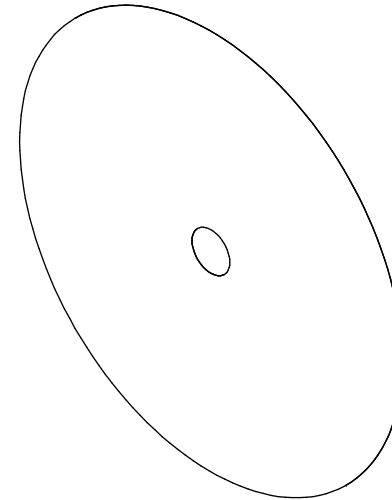
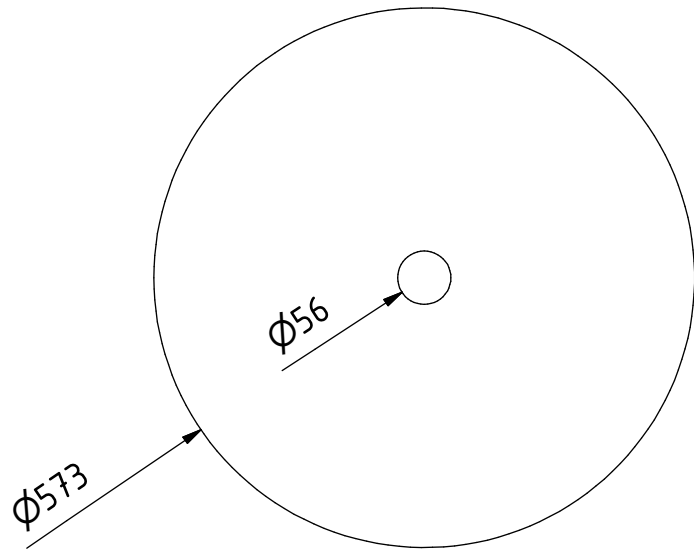

Note: all units are in mm

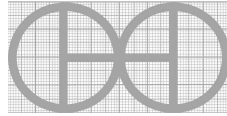
PROJEKT	ERSTELLT VON	GENEHMIGT VON	DATE	VERSION
Fischtrockner Raeucherei	J. Zeron	A. Morillo	08-06-2021	1.0
TEIL-NAME	DATEI-NAME			TEIL-CODE
Deckel	Lid.ipt			6
ENTWICKELT VON	UMGESTALET VON	DOK. TYP	WERKSTOFF	MENGE
		PART	Metallfassschrott	1
INTERNATIONAL LABOUR OFFICE	OHO e.V.	LIZENZ	SCALE	SEITE
		CC-BY-SA 4.0	1:8	9 / 17

# ELEVATION ( 1 : 10 )

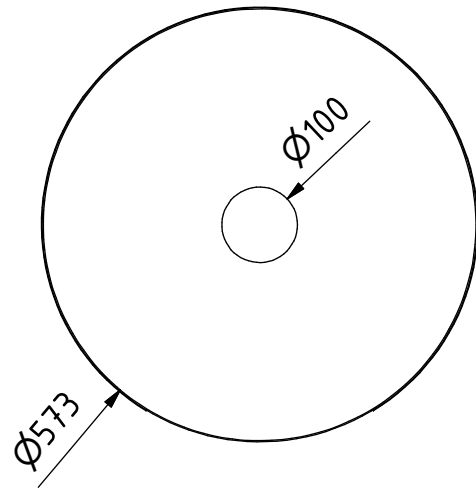
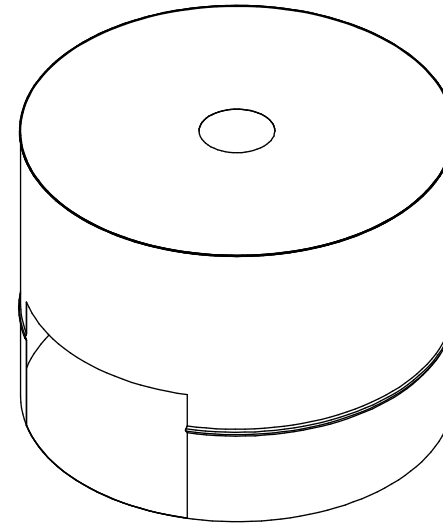
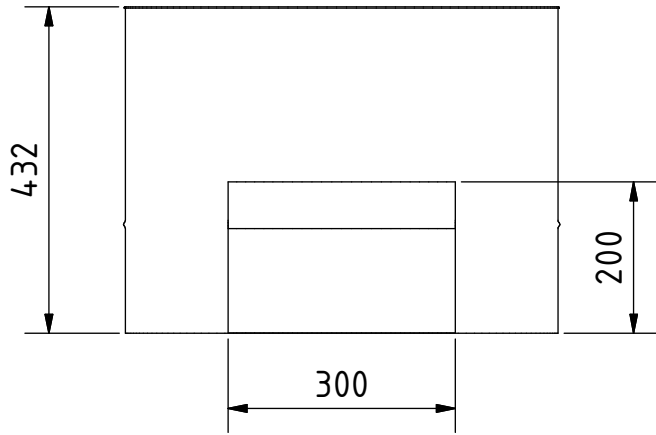

Note: all units are in mm

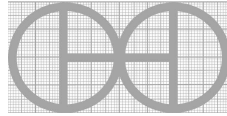
PROJEKT	ERSTELLT VON	GENEHMIGT VON	DATE	VERSION
Fischtrockner Raeucherei	J. Zeron	A. Morillo	08-06-2021	1.0
TEIL-NAME	DATEI-NAME			TEIL-CODE
Feuertrommel	Fire Drum.ipt			7
ENTWICKELT VON	UMGESTALET VON	DOK. TYP	WERKSTOFF	MENGE
		PART	Metallfassschrott	1
INTERNATIONAL LABOUR OFFICE	OHO e.V.	LIZENZ	SCALE	SEITE
		CC-BY-SA 4.0	1:10	10 / 17

PLAN ( 1 : 2 )

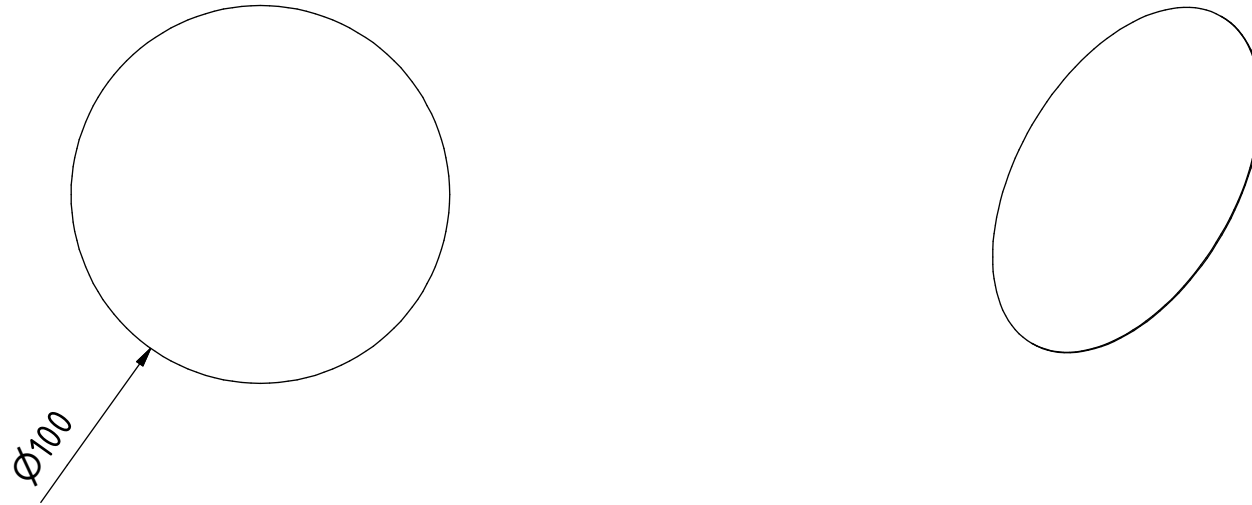

Note: all units are in mm

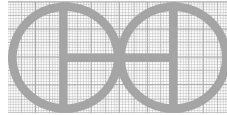
PROJEKT	ERSTELLT VON	GENEHMIGT VON	DATE	VERSION
Fischtrockner Raeucherei	J. Zeron	A. Morillo	08-06-2021	1.0
TEIL-NAME	DATEI-NAME			TEIL-CODE
Obere duse	Upper Nozzle.ipt			9
ENTWICKELT VON	UMGESTALET VON	DOK. TYP	WERKSTOFF	MENGE
		PART	Metallfassschrott	1
INTERNATIONAL LABOUR OFFICE	OHO e.V.	LIZENZ	SCALE	SEITE
		CC-BY-SA 4.0	1:2	11 /17

# ELEVATION ( 1 : 5 )

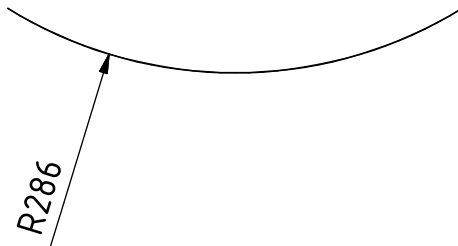
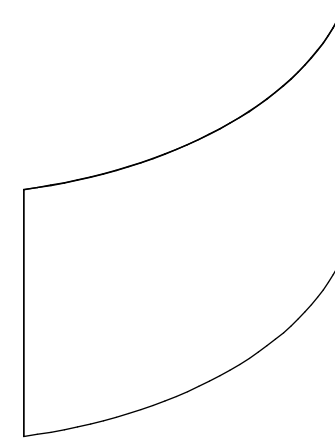
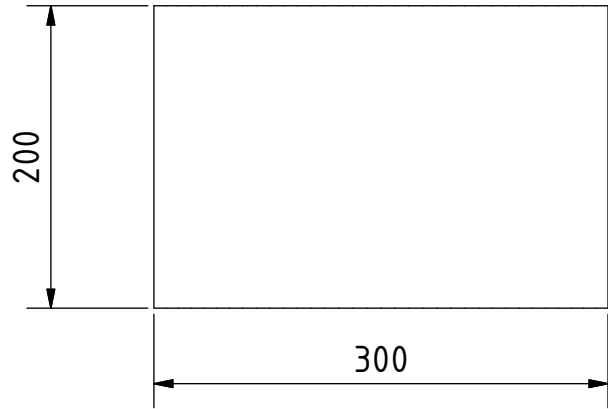

Note: all units are in mm

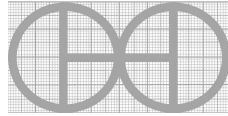
PROJEKT	ERSTELLT VON	GENEHMIGT VON	DATE	VERSION
Fischtrockner Raeucherei	J. Zeron	A. Morillo	08-06-2021	1.0
TEIL-NAME	DATEI-NAME			TEIL-CODE
Seiteneingang	Side Entrance.ipt			10
ENTWICKELT VON	UMGESTALET VON	DOK. TYP	WERKSTOFF	MENGE
		PART	Metallfassschrott	1
INTERNATIONAL LABOUR OFFICE	OHO e.V.	LIZENZ	SCALE	SEITE
		CC-BY-SA 4.0	1:5	12 /17

# ELEVATION ( 1 : 5 )

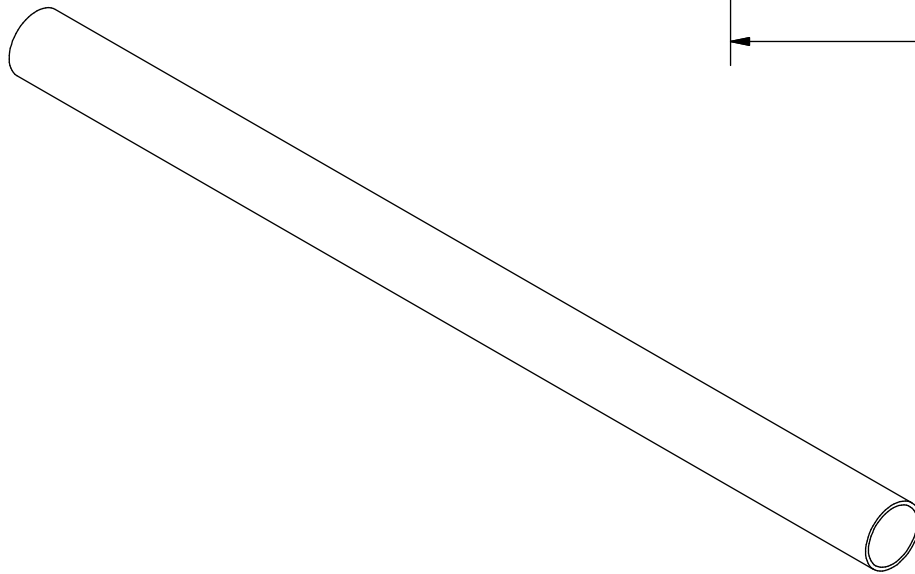
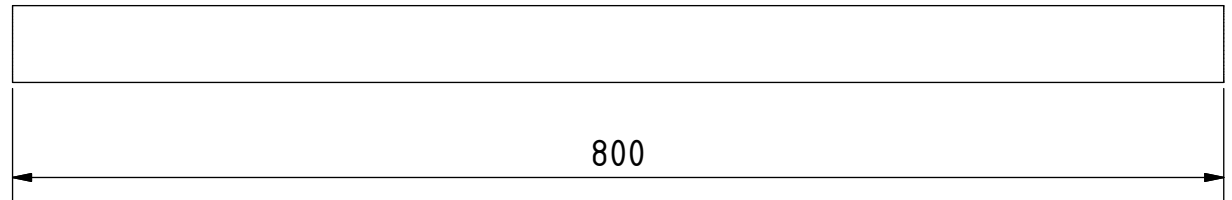
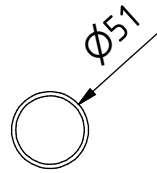

Note: all units are in mm

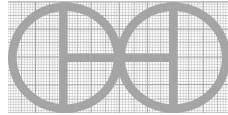
PROJEKT	ERSTELLT VON	GENEHMIGT VON	DATE	VERSION
Fischtrockner Raeucherei	J. Zeron	A. Morillo	08-06-2021	1.0
TEIL-NAME	DATEI-NAME			TEIL-CODE
Rohr A	Tube A.ipt			11
ENTWICKELT VON	UMGESTALET VON	DOK. TYP	WERKSTOFF	MENGE
		PART	Schwarzes eisen	1
INTERNATIONAL LABOUR OFFICE	OHO e.V.	LIZENZ	SCALE	SEITE
		CC-BY-SA 4.0	1:5	13 /17

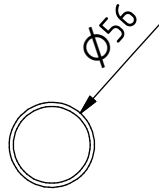

ELEVATION ( 1 : 5 )

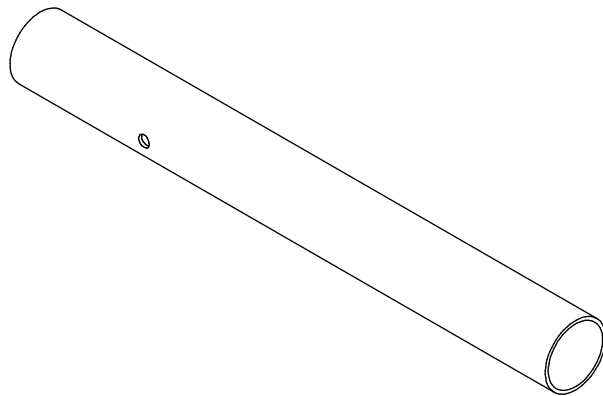
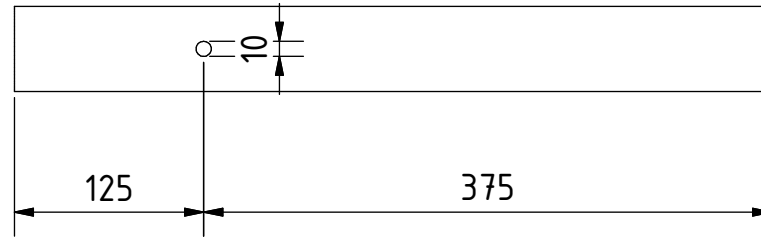

Note: all units are in mm

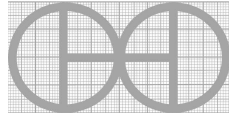
PROJEKT	ERSTELLT VON	GENEHMIGT VON	DATE	VERSION
Fischtrockner Raeucherei	J. Zeron	A. Morillo	08-06-2021	1.0
TEIL-NAME	DATEI-NAME			TEIL-CODE
Rohr B	Tube B.ipt			12
ENTWICKELT VON	UMGESTALET VON	DOK. TYP	WERKSTOFF	MENGE
		PART	Schwarzes eisen	1
INTERNATIONAL LABOUR OFFICE	OHO e.V.	LIZENZ	SCALE	SEITE
		CC-BY-SA 4.0	1:5	14 /17

# ELEVATION ( 1 : 3 )

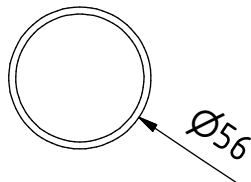
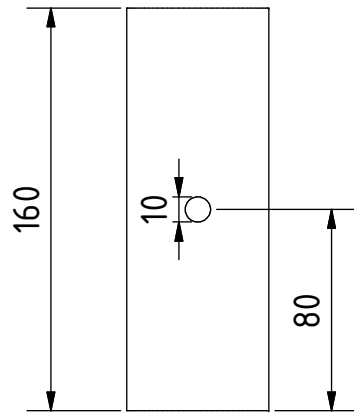

Note: all units are in mm

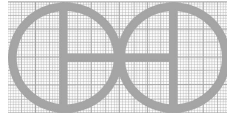
PROJEKT	ERSTELLT VON	GENEHMIGT VON	DATE	VERSION
Fischtrockner Raeucherei	J. Zeron	A. Morillo	08-06-2021	1.0
TEIL-NAME	DATEI-NAME			TEIL-CODE
Auspuffrohr	Exhaust Tube.ipt			13
ENTWICKELT VON	UMGESTALET VON	DOK. TYP	WERKSTOFF	MENGE
		PART	Schwarzes eisen	1
INTERNATIONAL LABOUR OFFICE	OHO e.V.	LIZENZ	SCALE	SEITE
		CC-BY-SA 4.0	1:3	15 /17

# PLAN ( 1 : 1 )

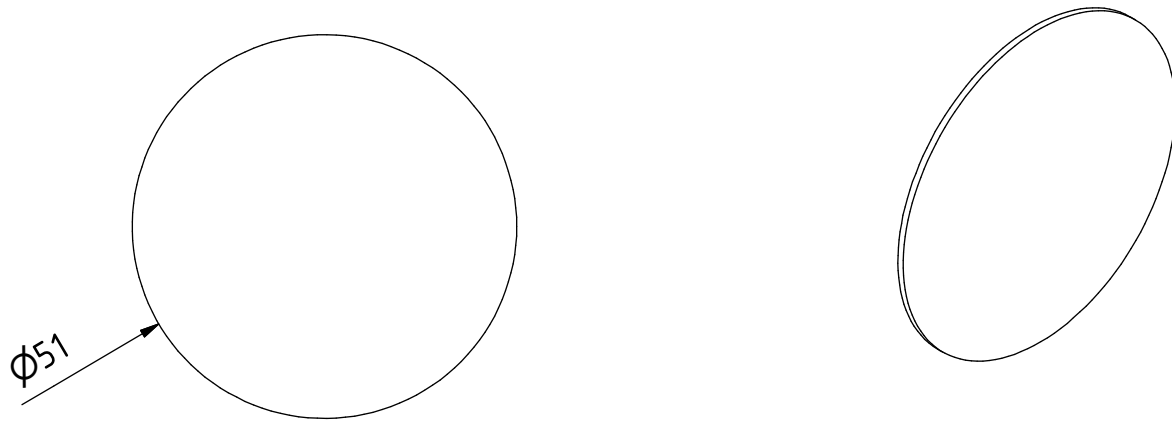

Note: all units are in mm

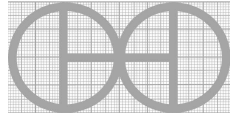
PROJEKT	ERSTELLT VON	GENEHMIGT VON	DATE	VERSION
Fischtrockner Raeucherei	J. Zeron	A. Morillo	08-06-2021	1.0
TEIL-NAME	DATEI-NAME			TEIL-CODE
Duse	Nozzle.ipt			14
ENTWICKELT VON	UMGESTALET VON	DOK. TYP	WERKSTOFF	MENGE
		PART	Blech	2
INTERNATIONAL LABOUR OFFICE	OHO e.V.	LIZENZ	SCALE	SEITE
		CC-BY-SA 4.0	1:1	16 /17



# PLAN ( 1 : 2 )

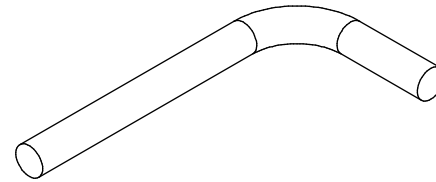
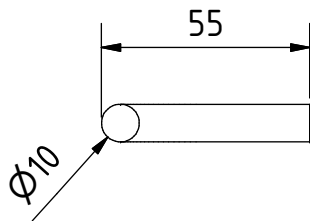
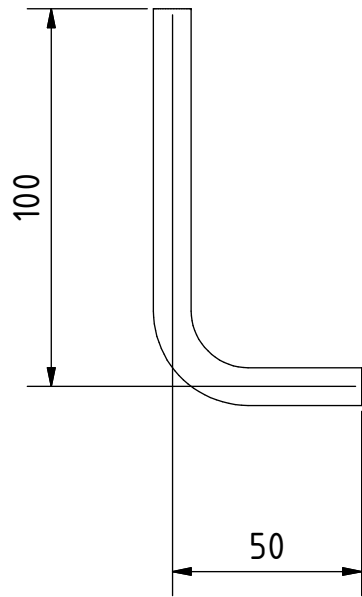

Note: all units are in mm

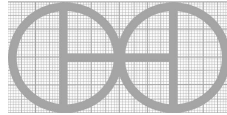
PROJEKT	ERSTELLT VON	GENEHMIGT VON	DATE	VERSION
Fischtrockner Raeucherei	J. Zeron	A. Morillo	08-06-2021	1.0
TEIL-NAME	DATEI-NAME			TEIL-CODE
Bar	Bar.ipt			15
ENTWICKELT VON	UMGESTALET VON	DOK. TYP	WERKSTOFF	MENGE
		PART	Flache stange	2
INTERNATIONAL LABOUR OFFICE	OHO e.V.	LIZENZ	SCALE	SEITE
		CC-BY-SA 4.0	1:2	17 / 17