

Hinweis: Alle einheiten in mm.

PROJEKT Maschine zur Herstellung von Zäunen	ERSTELLT VON E. Araujo	GENEHMIGT VON A. Morillo	DATE 23-06-2021	VERSION 1.0
TEIL-NAME 3D-Ansichten	DATEI-NAME Fence_making_machine.dwg			TEIL-CODE A1
ENTWICKELT VON Practical Action	UMGESTALTET VON OHO e.V.	DOK. TYP Assembly	WERKSTOFF	MENGE 1
		LIZENZ CC-BY-SA 4.0	SCALE 1:7.5	SEITE 1 / 17

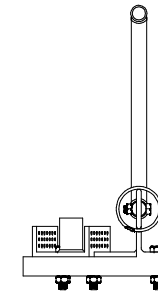
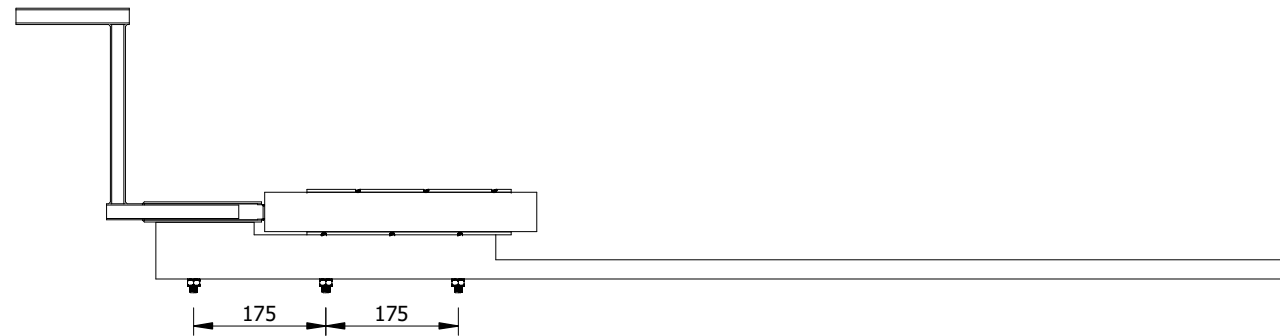
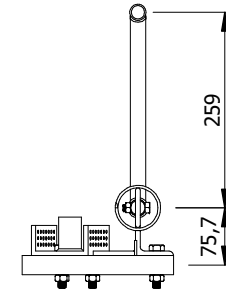
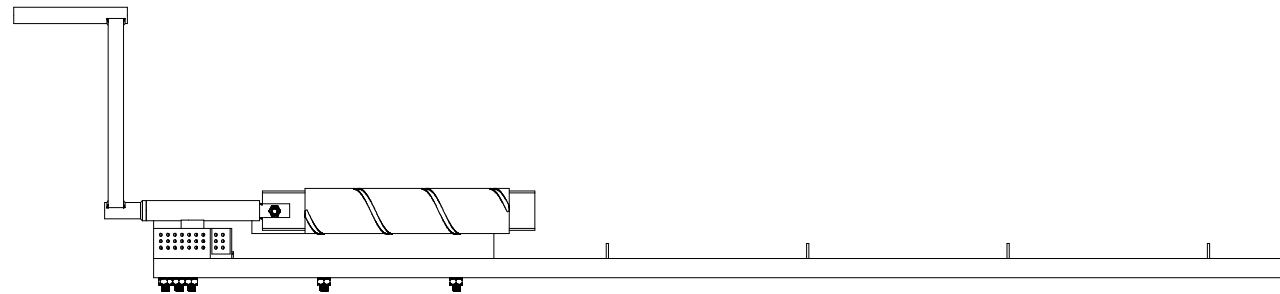
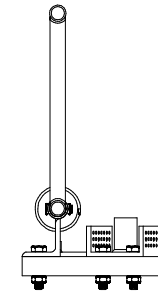
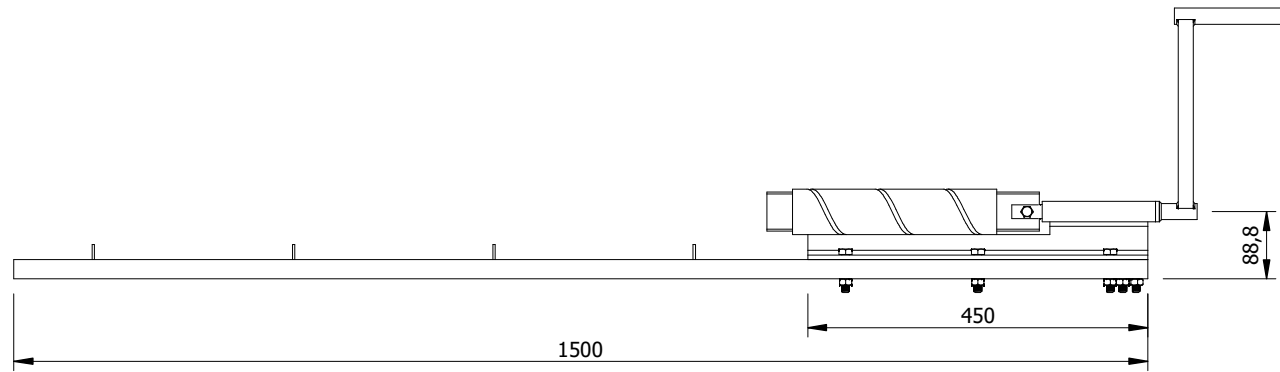
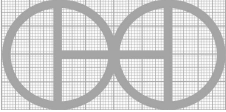

Hinweis: Alle einheiten in mm.

PROJEKT Maschine zur Herstellung von Zäunen	ERSTELLT VON E. Araujo	GENEHMIGT VON A. Morillo	DATE 23-06-2021	VERSION 1.0
TEIL-NAME 3D-Ansichten	DATEI-NAME Fence_making_machine.dwg			TEIL-CODE A1
ENTWICKELT VON	UMGESTALTET VON 	DOK. TYP Assembly	WERKSTOFF	MENGE 1
Practical Action	OHO e.V.	LIZENZ CC-BY-SA 4.0	SCALE 1:10	SEITE 2 / 17

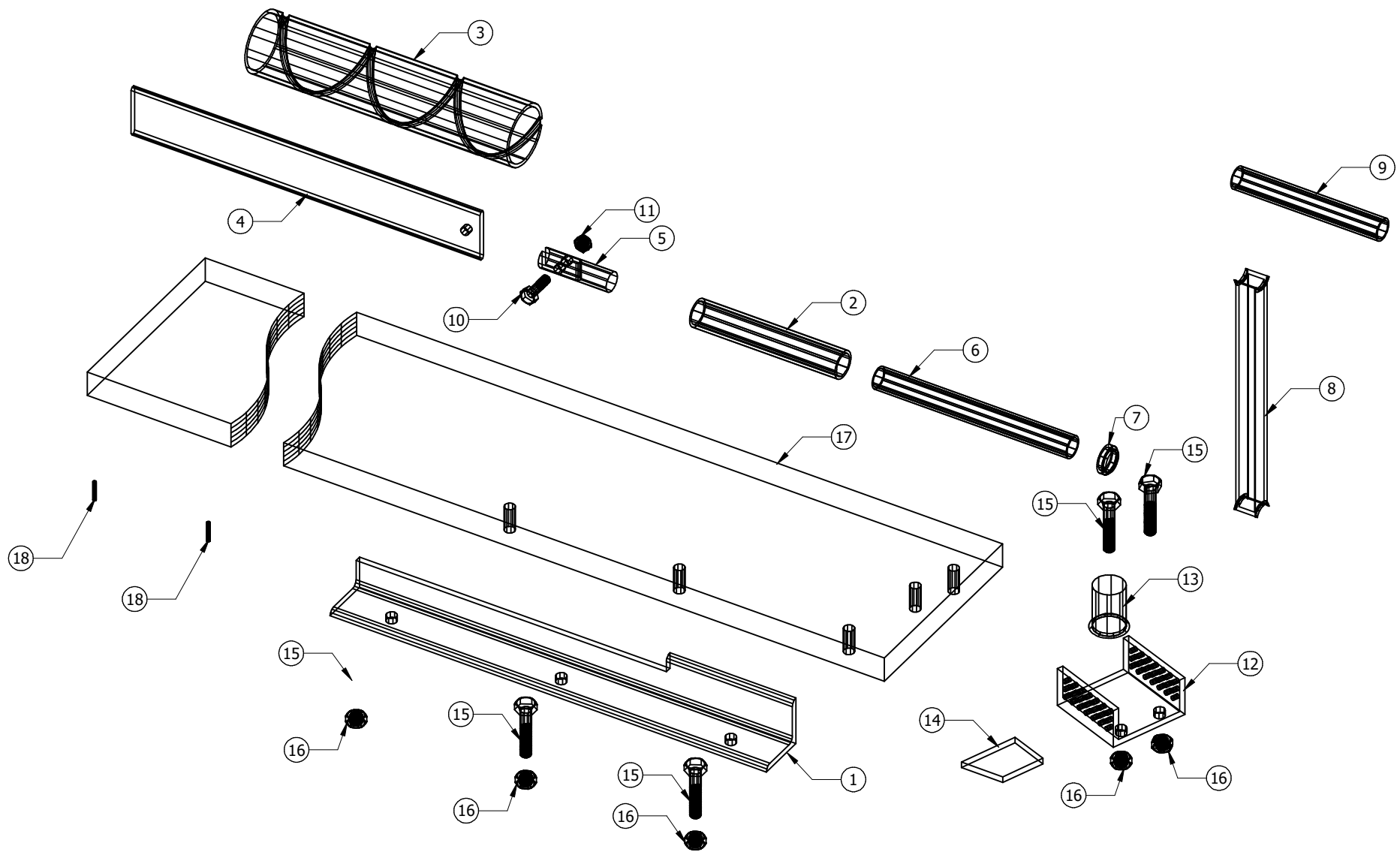

PROJEKT Maschine zur Herstellung von Zäunen	ERSTELLT VON E. Araujo	GENEHMIGT VON A. Morillo	DATE 23-06-2021	VERSION 1.0
TEIL-NAME 3d-Explosionsszeichnungen	DATEI-NAME Fence_making_machine.dwg			TEIL-CODE A2
ENTWICKELT VON	UMGESTALTET VON	DOK. TYP Assembly	WERKSTOFF	MENGE 1
Practical Action	OHO e.V.	LIZENZ CC-BY-SA 4.0	SCALE 1:5	SEITE 3 / 17

Parts list

POS	QTY	TEIL NAME	DATEI-NAME	TEIL-TYP	SPEZIFIKATIONEN	SEITE
A1	1	3d-Ansichten	Fence_making_machine.dwg			1
A1	1	3d-Ansichten	Fence_making_machine.dwg			2
A2	1	3d-Explosionsszeichnungen	Fence_making_machine.dwg			3
B1		Teileliste	BI-MW_PARTLIST_fence_making_m.xlsx			4
1	1	Rahmen	Fence_making_machine.dwg	Production	Winkelstahl A36	5
2	1	Lager	Fence_making_machine.dwg	Production	Dampfrohr Stahl A36	6
3	1	Schnecke	Fence_making_machine.dwg	Production	Dampfrohr Stahl A36	7
4	1	Klinge	Fence_making_machine.dwg	Production	Autoblattfeder Stahl C45	8
5	1	Kupplung	Fence_making_machine.dwg	Production	Rundstabstahl A36	9
6	1	Welle	Fence_making_machine.dwg	Production	Dampfrohr Stahl A36	10
7	1	Wellenanschlag	Fence_making_machine.dwg	Production	Dampfrohr Stahl A36	11
8	1	Arm	Fence_making_machine.dwg	Production	Dampfrohr Stahl A36	12
9	1	Handgriff	Fence_making_machine.dwg	Production	Dampfrohr Stahl A36	13
10	1	Schraube	Fence_making_machine.dwg	Buy	M8 Schraube x 35	
11	1	Mutter	Fence_making_machine.dwg	Buy	M8 Mutter	
12	1	Drahtvorschub	Fence_making_machine.dwg	Production	Kanalstahl C45	14
13	1	Vollstange	Fence_making_machine.dwg	Production	Rundstahl C45	15
14	1	Flache Stange	Fence_making_machine.dwg	Production	Flacher Stabstahl C45	16
15	5	Schraube	Fence_making_machine.dwg	Buy	M8-Schraube x 50	
16	5	Mutter	Fence_making_machine.dwg	Buy	M8 Mutter	
17	1	Holzplatte als Stütze	Fence_making_machine.dwg	Production	Holz	17
18	4	Nagel	Fence_making_machine.dwg	Buy	Kopflose Nägel 50mm x 2,80mm	

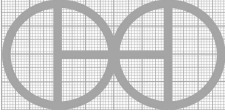
PROJEKT Maschine zur Herstellung von Zäunen		ERSTELLT VON E. Araujo		GENEHMIGT VON A. Morillo		DATE 23-06-2021		VERSION 1.0	
TEIL-NAME Teileliste			DATEI-NAME BI-MW_PARTLIST_fence_making_m.xlsx					TEIL-CODE B1	
ENTWICKELT VON Practical Action		UMGESTALTET VON  OHO e.V.		DOK. TYP Parts list		WERKSTOFF		MENGE	
				LIZENZ CC-BY-SA 4.0		SCALE		SEITE 4 / 17	

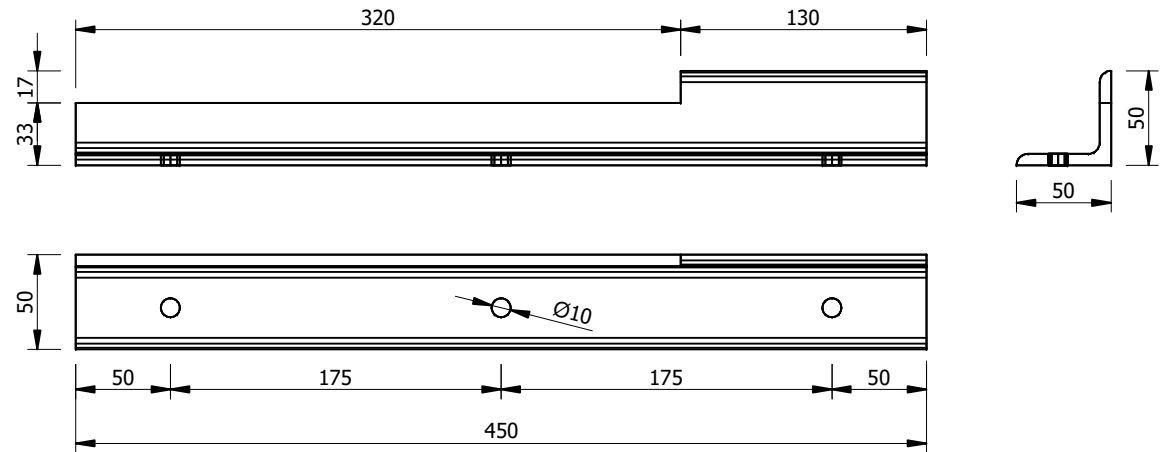
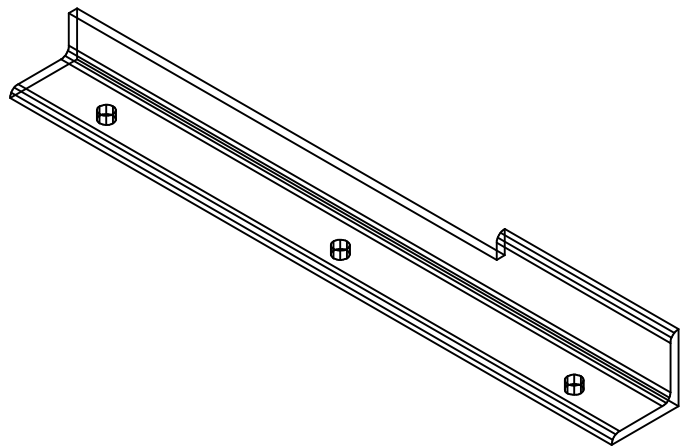

Hinweis: Alle einheiten in mm

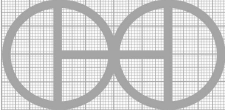
PROJEKT Maschine zur Herstellung von Zäunen	ERSTELLT VON E. Araujo	GENEHMIGT VON A. Morillo	DATE 23-06-2021	VERSION 1.0
TEIL-NAME Rahmen	DATEI-NAME Fence_making_machine.dwg			TEIL-CODE 1
ENTWICKELT VON	UMGESTALTET VON 	DOK. TYP Part	WERKSTOFF Stahl A36	MENGE 1
Practical Action	OHO e.V.	LIZENZ CC-BY-SA 4.0	SCALE 1:4	SEITE 5 / 17

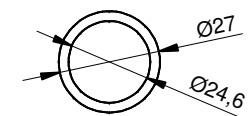
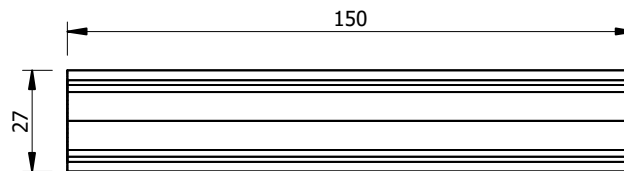
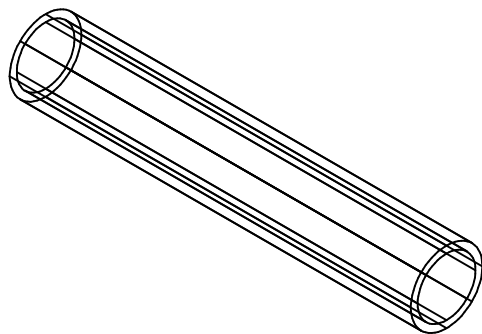

Hinweis: Alle einheiten in mm

PROJEKT Maschine zur Herstellung von Zäunen	ERSTELLT VON E. Araujo	GENEHMIGT VON A. Morillo	DATE 23-06-2021	VERSION 1.0
TEIL-NAME Lager	DATEI-NAME Fence_making_machine.dwg			TEIL-CODE 2
ENTWICKELT VON Practical Action	UMGESTALTET VON OHO e.V.	DOK. TYP Part	WERKSTOFF Stahl A36	MENGE 1
		LIZENZ CC-BY-SA 4.0	SCALE 1:4	SEITE 6 / 17

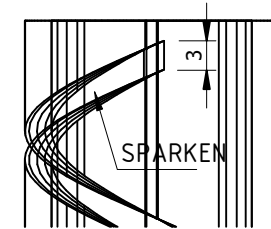
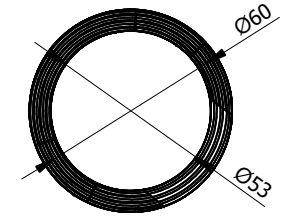
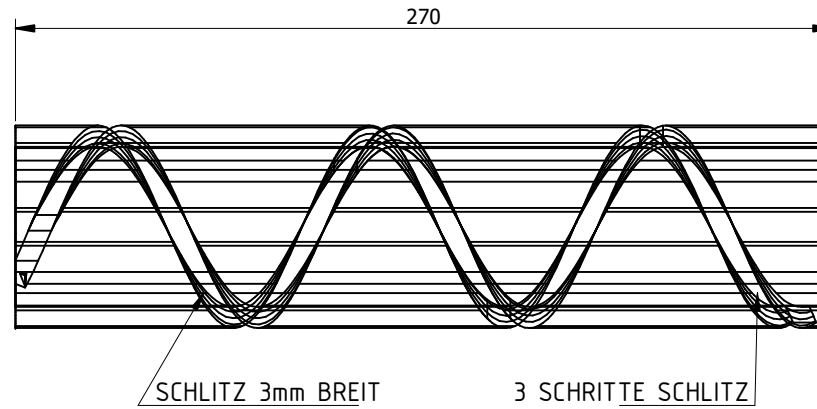
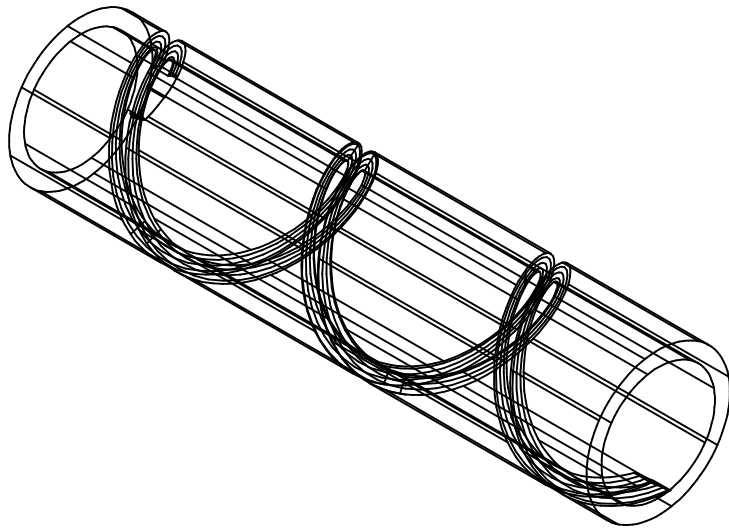

Hinweis: Alle einheiten in mm

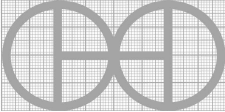
PROJEKT Maschine zur Herstellung von Zäunen	ERSTELLT VON E. Araujo	GENEHMIGT VON A. Morillo	DATE 23-06-2021	VERSION 1.0
TEIL-NAME Schnecke	DATEI-NAME Fence_making_machine.dwg			TEIL-CODE 3
ENTWICKELT VON	UMGESTALTET VON 	DOK. TYP Part	WERKSTOFF Stahl A36	MENGE 1
Practical Action	OHO e.V.	LIZENZ CC-BY-SA 4.0	SCALE 1:4	SEITE 7 / 17

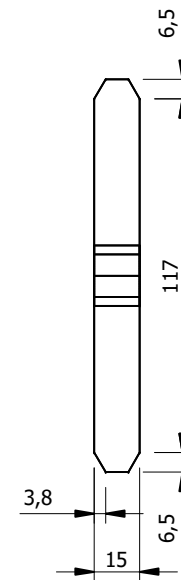
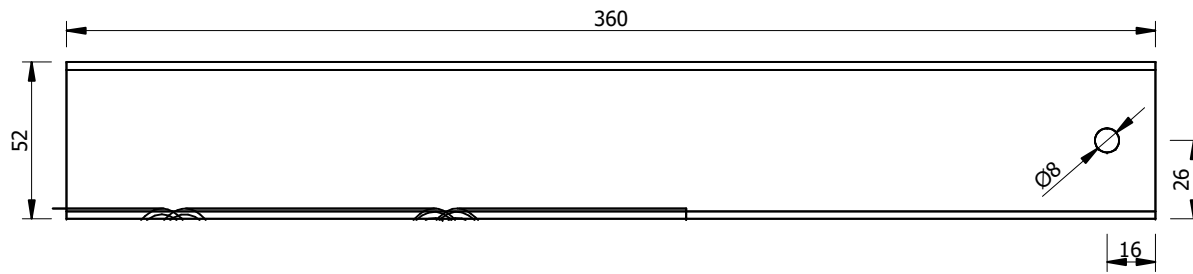
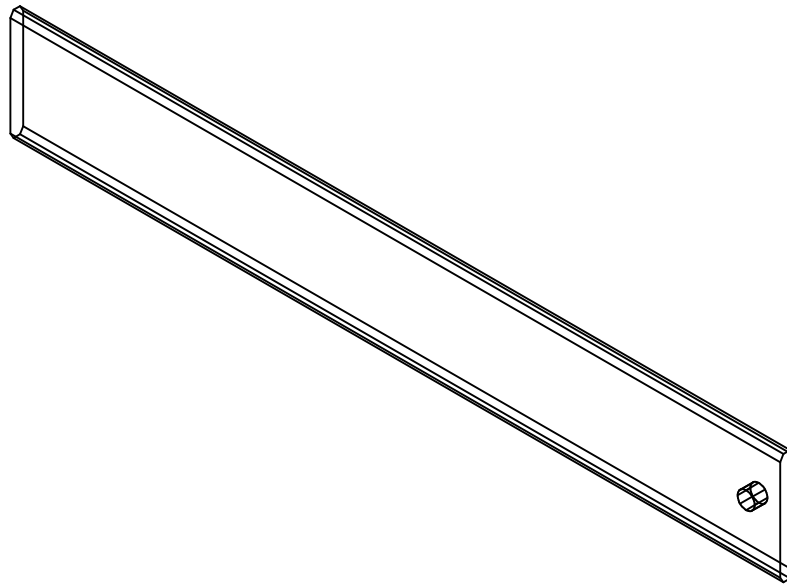

Hinweis: Alle einheiten in mm

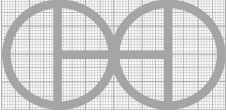
PROJEKT Maschine zur Herstellung von Zäunen	ERSTELLT VON E. Araujo	GENEHMIGT VON A. Morillo	DATE 23-06-2021	VERSION 1.0
TEIL-NAME Klinge	DATEI-NAME Fence_making_machine.dwg			TEIL-CODE 4
ENTWICKELT VON	UMGESTALTET VON	DOK. TYP	WERKSTOFF	MENGE
		Part	Stahl A36	1
Practical Action	OHO e.V.	LIZENZ CC-BY-SA 4.0	SCALE 1:4	SEITE 8 /17



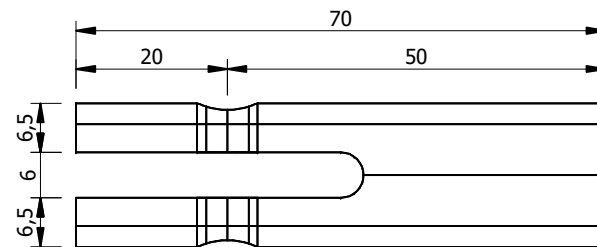
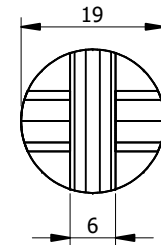
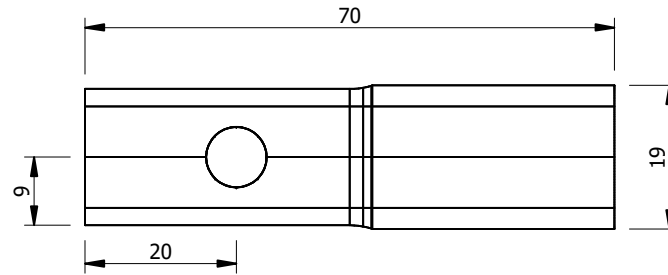
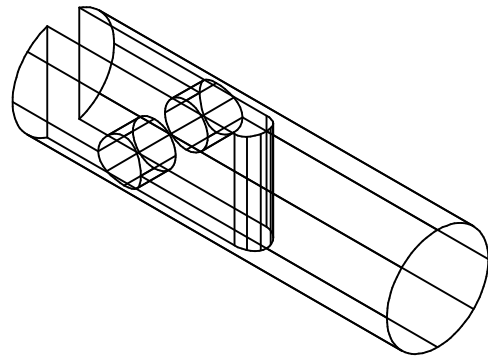

Hinweis: Alle einheiten in mm

PROJEKT Maschine zur Herstellung von Zäunen	ERSTELLT VON E. Araujo	GENEHMIGT VON A. Morillo	DATE 23-06-2021	VERSION 1.0
TEIL-NAME Kupplung	DATEI-NAME Fence_making_machine.dwg			TEIL-CODE 5
ENTWICKELT VON Practical Action	UMGESTALTET VON OHO e.V.	DOK. TYP Part	WERKSTOFF Stahl A36	MENGE 1
		LIZENZ CC-BY-SA 4.0	SCALE 1:4	SEITE 9 / 17

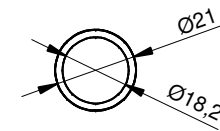
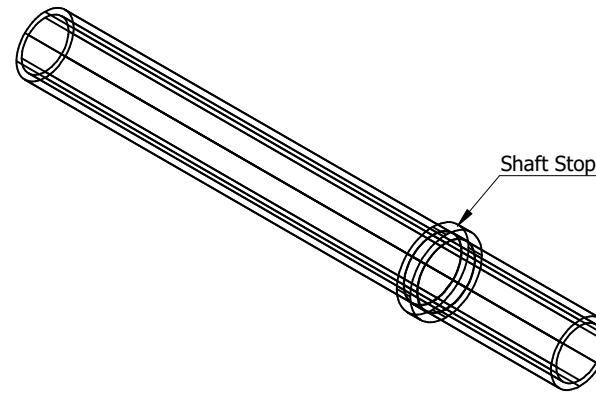
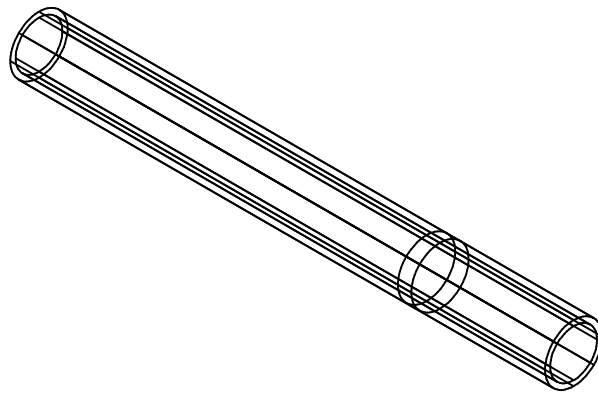

Hinweis: Alle einheiten in mm

PROJEKT Maschine zur Herstellung von Zäunen	ERSTELLT VON E. Araujo	GENEHMIGT VON A. Morillo	DATE 23-06-2021	VERSION 1.0
TEIL-NAME Welle	DATEI-NAME Fence_making_machine.dwg			TEIL-CODE 6
ENTWICKELT VON Practical Action	UMGESTALTET VON OHO e.V.	DOK. TYP Part	WERKSTOFF Stahl A36	MENGE 1
		LIZENZ CC-BY-SA 4.0	SCALE 1:4	SEITE 10 /17

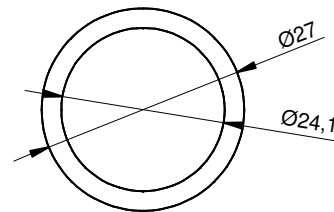
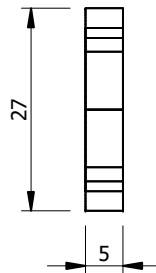
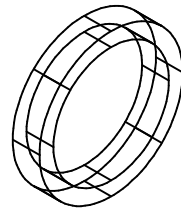

Hinweis: Alle einheiten in mm

PROJEKT Maschine zur Herstellung von Zäunen	ERSTELLT VON E. Araujo	GENEHMIGT VON A. Morillo	DATE 23-06-2021	VERSION 1.0
TEIL-NAME Wellenanschlag	DATEI-NAME Fence_making_machine.dwg			TEIL-CODE 7
ENTWICKELT VON Practical Action	UMGESTALTET VON OHO e.V.	DOK. TYP Part	WERKSTOFF Stahl A36	MENGE 1
		LIZENZ CC-BY-SA 4.0	SCALE 1:4	SEITE 11 / 17

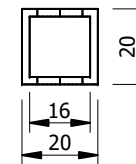
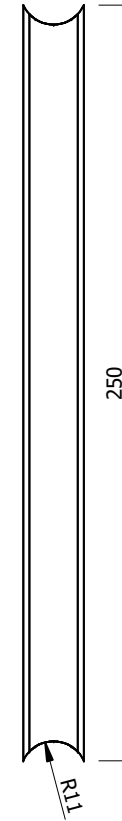
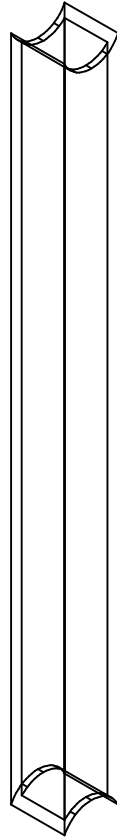

Hinweis: Alle einheiten in mm

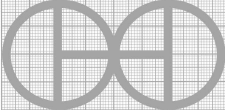
PROJEKT Maschine zur Herstellung von Zäunen	ERSTELLT VON E. Araujo	GENEHMIGT VON A. Morillo	DATE 23-06-2021	VERSION 1.0
TEIL-NAME Arm	DATEI-NAME Fence_making_machine.dwg			TEIL-CODE 8
ENTWICKELT VON	UMGESTALTET VON 	DOK. TYP Part	WERKSTOFF Stahl A36	MENGE 1
Practical Action	OHO e.V.	LIZENZ CC-BY-SA 4.0	SCALE 1:4	SEITE 12 /17

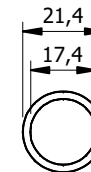
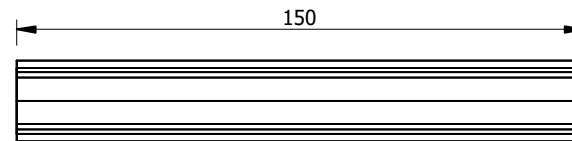
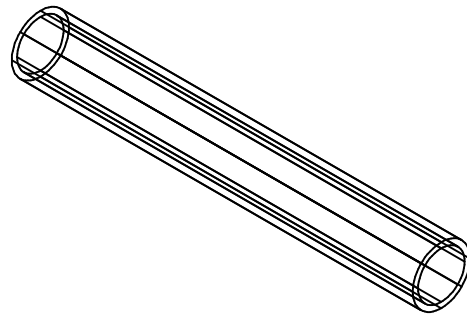

Hinweis: Alle einheiten in mm

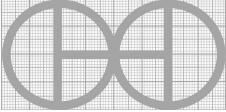
PROJEKT Maschine zur Herstellung von Zäunen	ERSTELLT VON E. Araujo	GENEHMIGT VON A. Morillo	DATE 23-06-2021	VERSION 1.0
TEIL-NAME Handgriff	DATEI-NAME Fence_making_machine.dwg			TEIL-CODE 9
ENTWICKELT VON	UMGESTALTET VON 	DOK. TYP Part	WERKSTOFF Stahl A36	MENGE 1
Practical Action	OHO e.V.	LIZENZ CC-BY-SA 4.0	SCALE 1:4	SEITE 13 /17

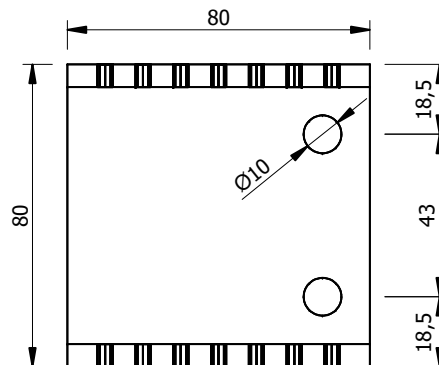
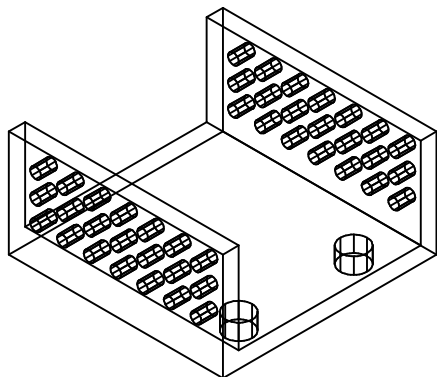

21 x Ø4mm HOLES  
DRILLED IN BOTH  
SIDE FLANGES  
OF 80 x 40 CHANNEL

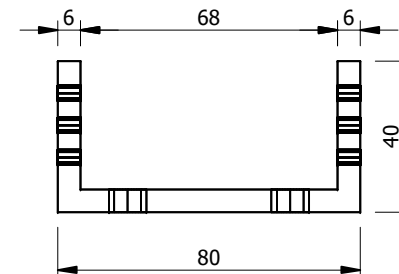
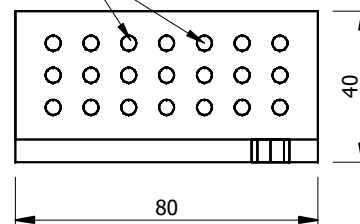

Hinweis: Alle einheiten in mm

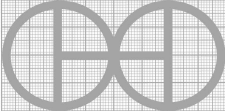
PROJEKT Maschine zur Herstellung von Zäunen	ERSTELLT VON E. Araujo	GENEHMIGT VON A. Morillo	DATE 23-06-2021	VERSION 1.0
TEIL-NAME Drahtvorschub	DATEI-NAME Fence_making_machine.dwg			TEIL-CODE 12
ENTWICKELT VON	UMGESTALTET VON 	DOK. TYP Part	WERKSTOFF Stahl A36	MENGE 1
Practical Action	OHO e.V.	LIZENZ CC-BY-SA 4.0	SCALE 1:4	SEITE 14 / 17

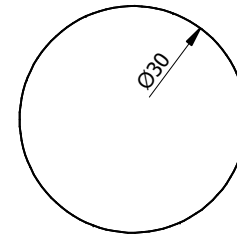
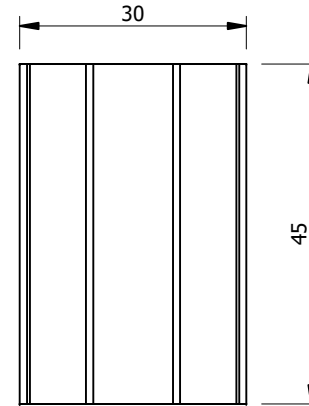
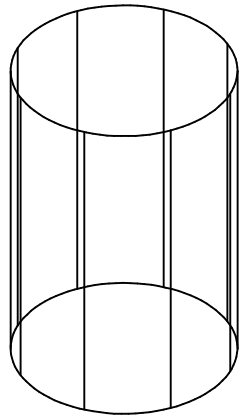

Hinweis: Alle einheiten in mm

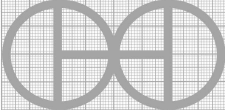
PROJEKT Maschine zur Herstellung von Zäunen	ERSTELLT VON E. Araujo	GENEHMIGT VON A. Morillo	DATE 23-06-2021	VERSION 1.0
TEIL-NAME Vollstange	DATEI-NAME Fence_making_machine.dwg			TEIL-CODE 13
ENTWICKELT VON  Practical Action	UMGESTALTET VON  OHO e.V.	DOK. TYP Part	WERKSTOFF Stahl A36	MENGE 1
		LIZENZ CC-BY-SA 4.0	SCALE 1:4	SEITE 15 /17

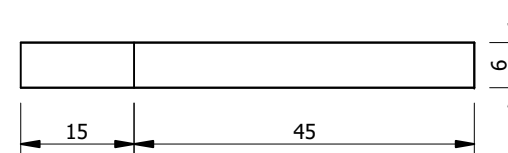
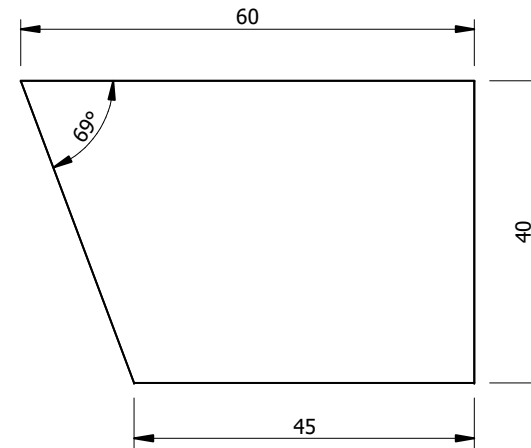
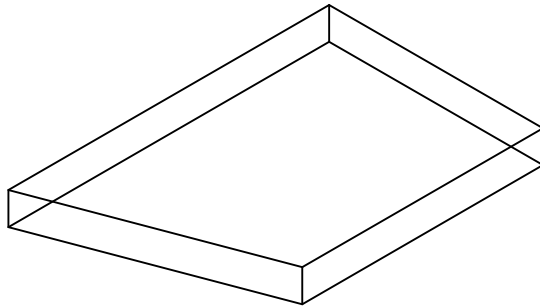

Hinweis: Alle einheiten in mm

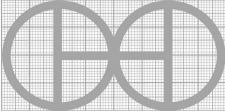
PROJEKT Maschine zur Herstellung von Zäunen	ERSTELLT VON E. Araujo	GENEHMIGT VON A. Morillo	DATE 23-06-2021	VERSION 1.0
TEIL-NAME Flache Stange	DATEI-NAME Fence_making_machine.dwg			TEIL-CODE 14
ENTWICKELT VON	UMGESTALTET VON 	DOK. TYP Part	WERKSTOFF Stahl A36	MENGE 1
Practical Action	OHO e.V.	LIZENZ CC-BY-SA 4.0	SCALE 1:4	SEITE 16 /17



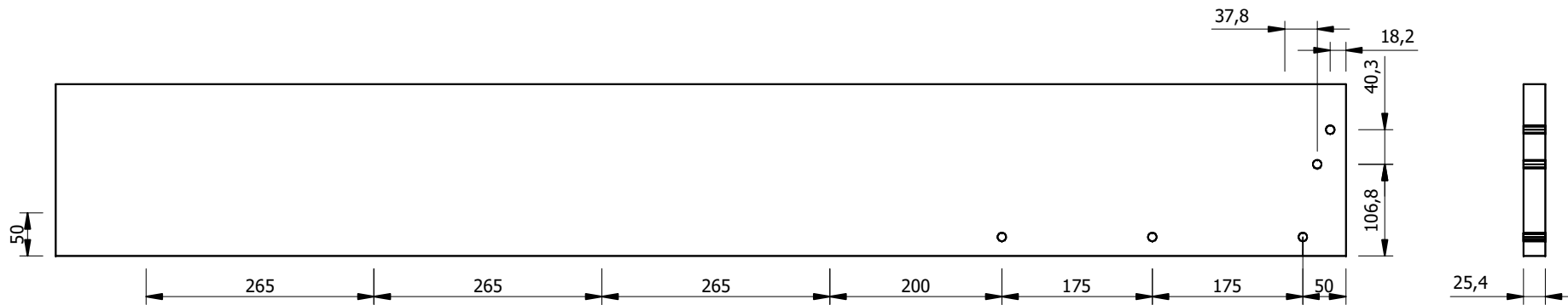
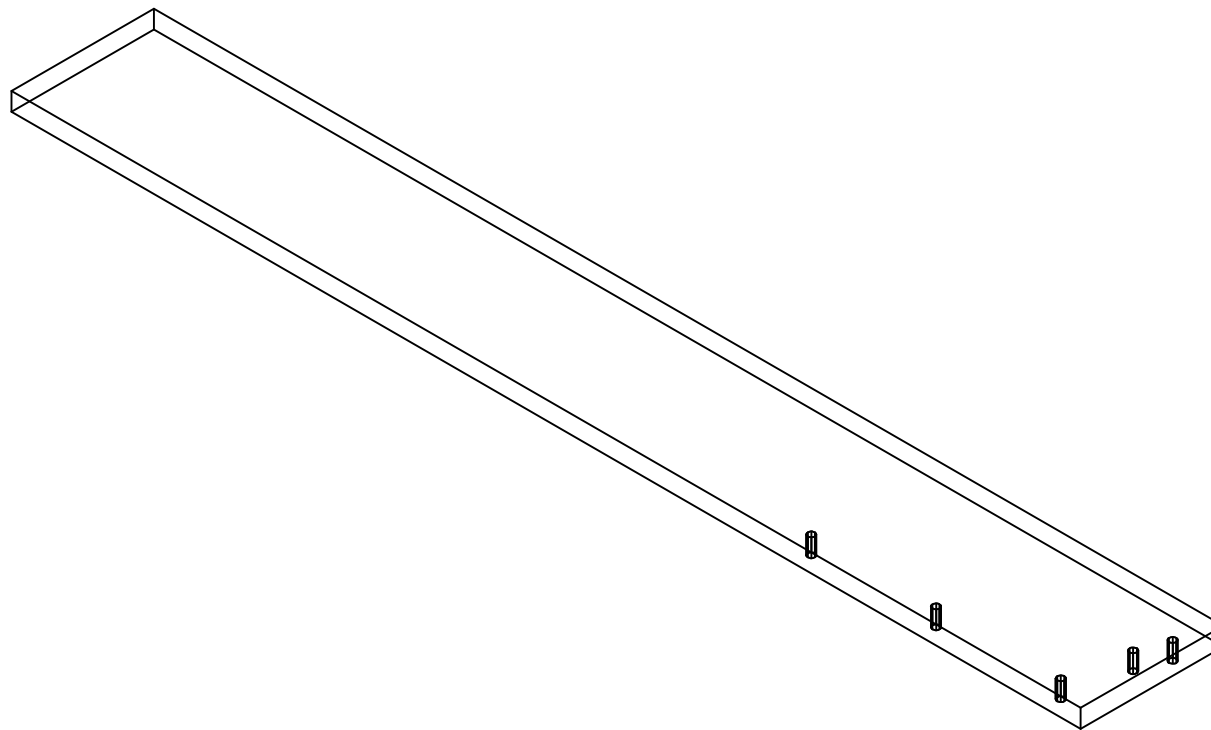

Hinweis: Alle einheiten in mm

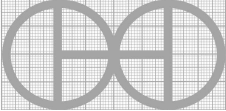
PROJEKT Maschine zur Herstellung von Zäunen	ERSTELLT VON E. Araujo	GENEHMIGT VON A. Morillo	DATE 23-06-2021	VERSION 1.0
TEIL-NAME Holzplatte als Stütze	DATEI-NAME Fence_making_machine.dwg			TEIL-CODE 17
ENTWICKELT VON	UMGESTALTET VON 	DOK. TYP Part	WERKSTOFF Holz	MENGE 1
Practical Action	OHO e.V.	LIZENZ CC-BY-SA 4.0	SCALE 1:4	SEITE 17 /17