







PROJECT		CREATED BY	APROVED BY	DATE	VERSION
Cross Flow Turbine		D.MOSQUERA	D. JAEGER	05-04-21	1.0
PART NAME		FILE NAME			PART CODE
Butterfly Valve shaft		oseg_cft_Butterfly-Valve-shaft.iam			6.7.0
DEVELOPED BY	REDESIGNED BY	SUPPORTED BY	DOC. TYPE	MATERIAL	QUANTITY
	 OPEN SOURCE ECOLOGY GERMANY OSEG		ASSEMBLY LICENCE		1
			CC.BY.SA 4.0	SCALE	SHEET
			1:2		64 /90

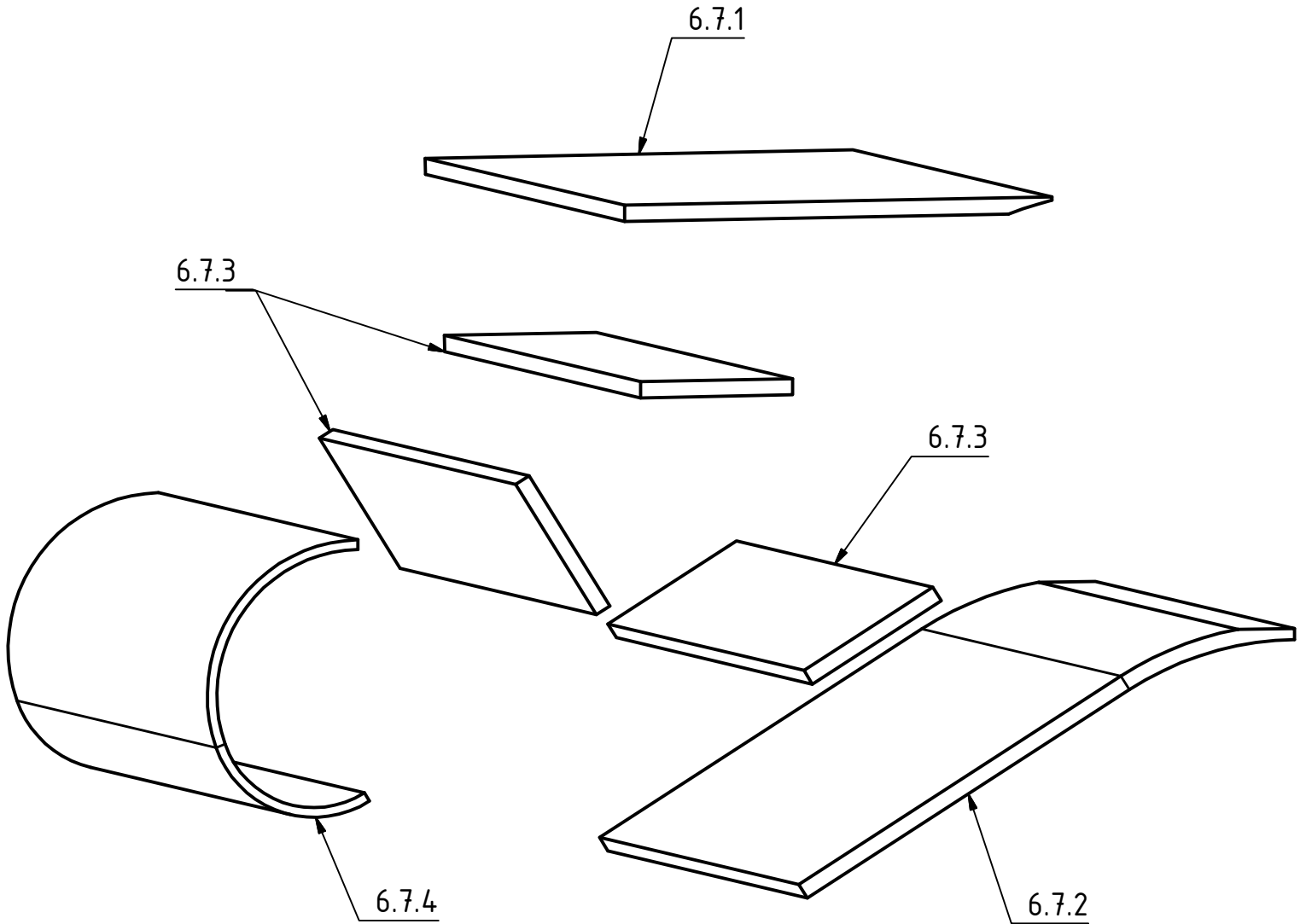

PROJECT		CREATED BY	APPROVED BY	DATE	VERSION
Cross Flow Turbine		D.MOSQUERA	D. JAEGER	05-04-21	1.0
PART NAME		FILE NAME			PART CODE
Butterfly Valve shaft		oseg_cft_Butterfly-Valve-shaft.ipn			6.7.0
DEVELOPED BY	REDESIGNED BY	SUPPORTED BY	DOC. TYPE	MATERIAL	QUANTITY
			ASSEMBLY		1
			LICENCE	SCALE	SHEET
			CC.BY.SA 4.0		65 /90