

A-A  
1226

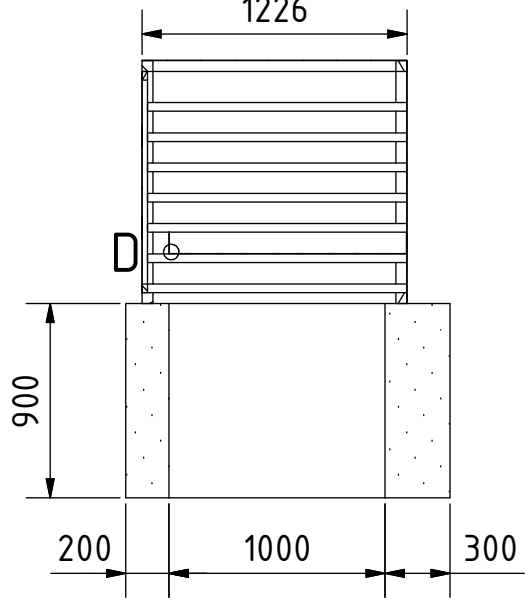

B-B  
1300

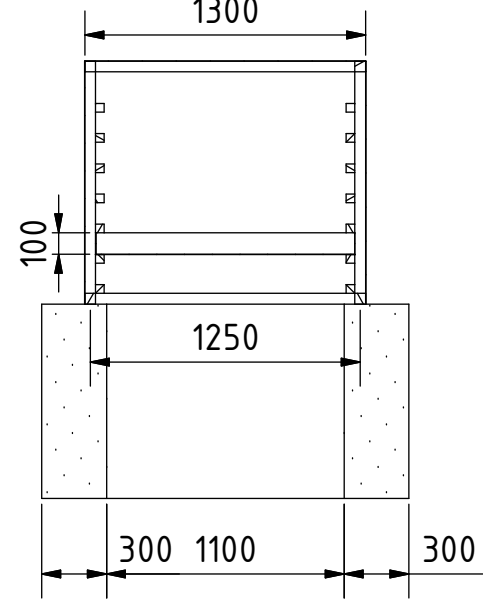

D ( 1 : 5 )

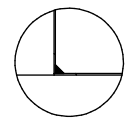

C-C

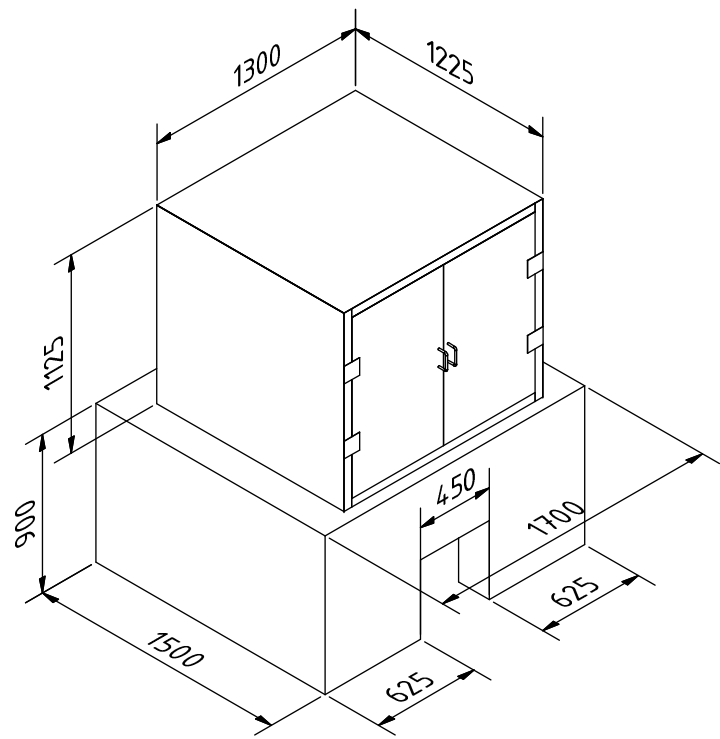
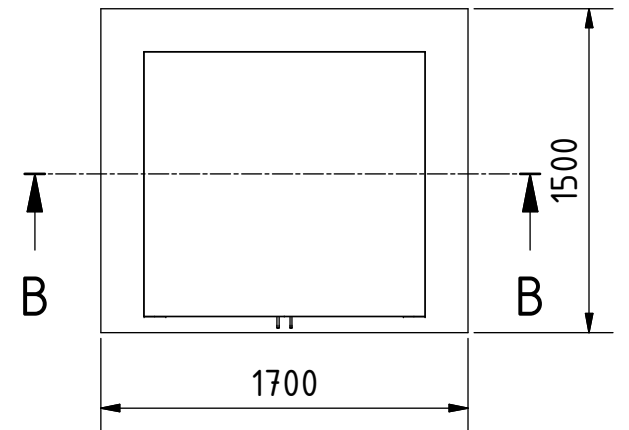
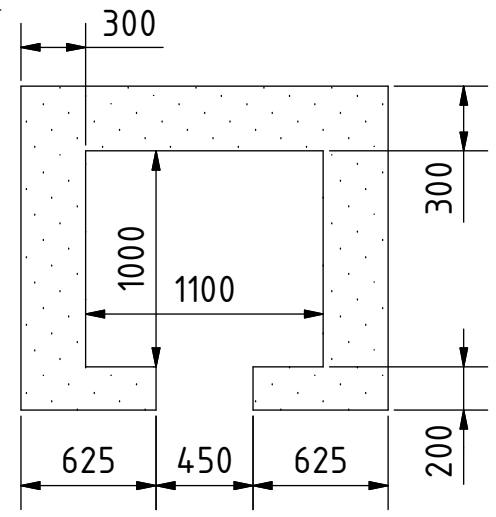
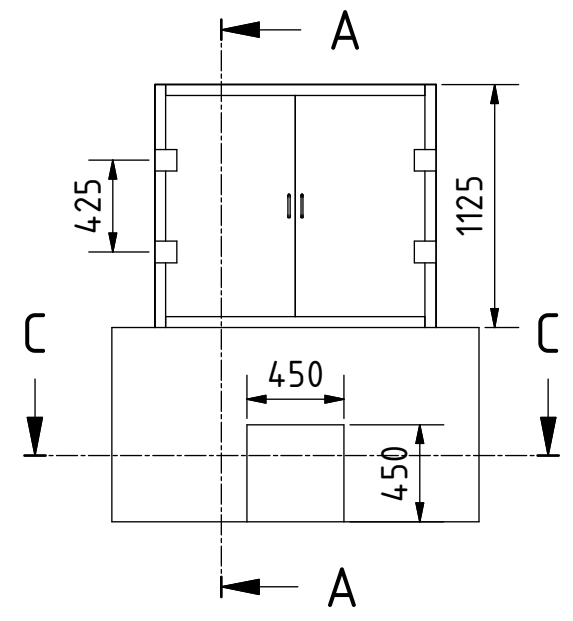

Hinweis: Alle einheiten in mm.

PROJEKT	ERSTELLT VON	GENEHMIGT VON	DATE	VERSION
Fischtrockner Smoker	J. Zeron	A. Morillo	09/08/2021	1.0
TEIL-NAME	DATEI-NAME	TEIL-CODE		
3d-Ansichten	ilo_fds_fish-dryer_smoker.iam	A1		
ENTWICKELT VON	UMGESTALTET VON	DOK. TYP	WERKSTOFF	MENGE
		Assembly		
International Labour Office OHO e.V.		LIZENZ	SCALE	SEITE
		CC-BY-SA 4.0	1:35	1 / 12

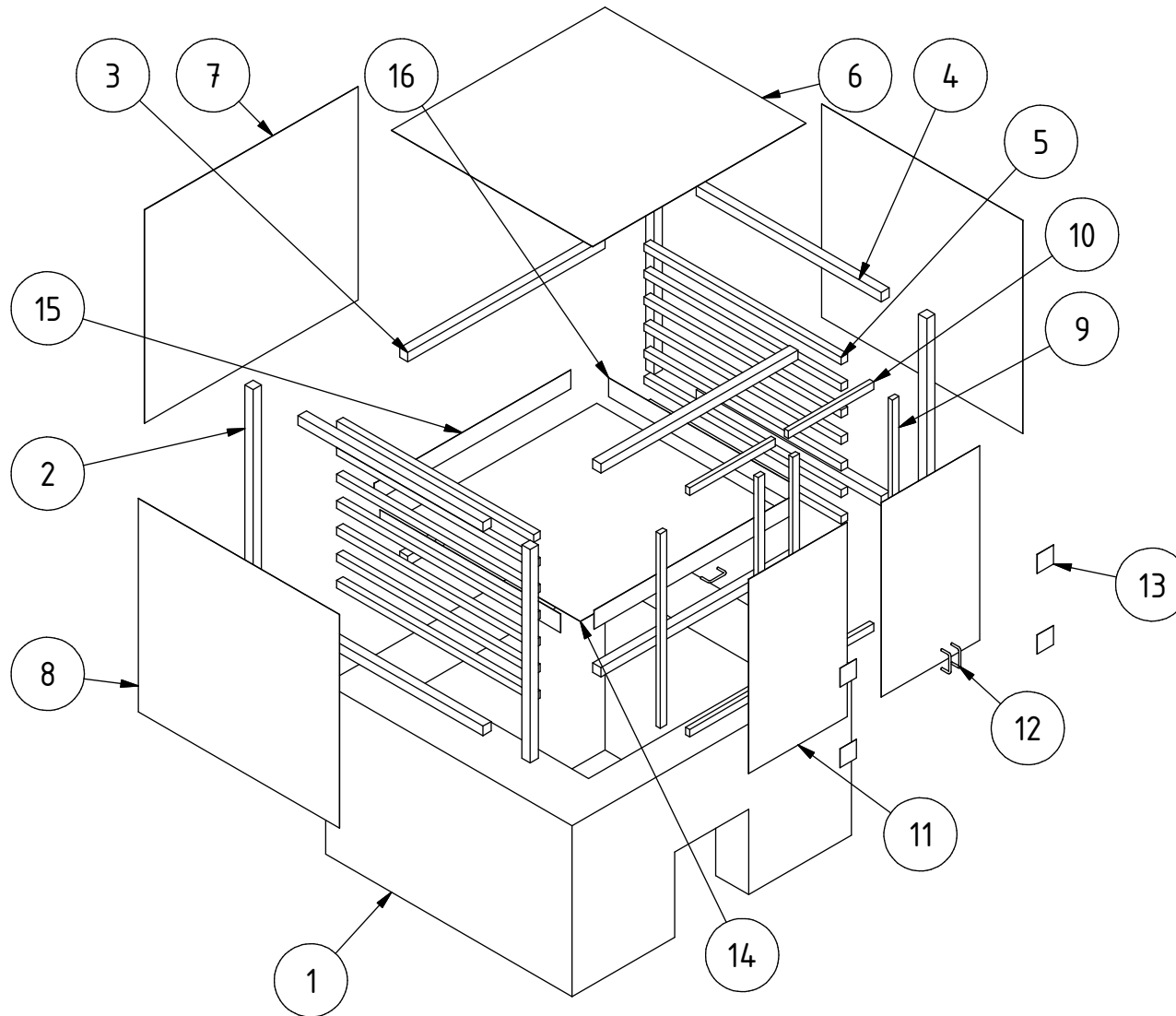

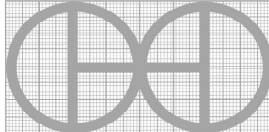
PROJEKT	ERSTELLT VON	GENEHMIGT VON	DATE	VERSION
Fischtrockner Smoker	J. Zeron	A. Morillo	09/08/2021	1.0
TEIL-NAME	DATEI-NAME			TEIL-CODE
Explosionsdarstellung 3d	ilo_fds_fish-dryer_smoker.ipn			A2
ENTWICKELT VON	UMGESTALTET VON	DOK. TYP	WERKSTOFF	MENGE
		Assembly		-
International Labour Office OHO e.V.		LIZENZ	SCALE	SEITE
		CC-BY-SA 4.0	1:30	2 /12

Parts list

POS	QTY	TEIL NAME	DATEI-NAME	TEIL-TYP	SPEZIFIKATIONEN	SEITE
A1	-	3d-Ansichten	ilo_fds_fish-dryer_smoker.iam	-	-	1
A2	-	Explosionsdarstellung 3d	ilo_fds_fish-dryer_smoker.ipn	-	-	2
B1	-	Teileliste	ilo_fds_fish-dryer_smoker.csv	-	-	3
1	1	Feuerbüchse	Fire box.ipt	Production	Hergestellt mit Tonblöcken	4
2	4	Hölzerne Säule	-	Production	Getrocknetes Holz 50x50x1125mm	-
3	4	Holzbalken A	-	Production	Getrocknetes Holz 50x50x1200mm	-
4	4	Holzbalken B	-	Production	Getrocknetes Holz 50x50x1125mm	-
5	14	Holzbalken C	-	Production	Getrocknetes Holz 40x40x1200mm	-
6	1	Obere Abdeckung	Top cover.ipt	Production	0,7mm dickes gewelltes Blech 1225x1300mm	5
7	1	Rückwand	Back cover.ipt	Production	0,7mm dickes gewelltes Blech 1300x1125mm	6
8	2	Seitliche Abdeckung	Side cover.ipt	Production	0,7 mm dickes gewelltes Blech 1225x1125 mm	7
9	2	Türrahmen A	-	Production	Getrocknetes Holz 40x25x1025mm	-
10	2	Türrahmen B	-	Production	Getrocknetes Holz 40x25x520mm	-
11	2	Abdeckung der Tür	Door cover.ipt	Production	0,7 mm dickes gewelltes Blech 600x1025 mm	8
12	16	Handgriff	Handle.ipt	Production	Stahl A36 Stab 10mm	9
13	4	Scharnier	-	Buy	Messing 50x72mm	-
14	7	Ablageblech A	Tray sheet A.ipt	Production	0,7mm dickes gewelltes Blech 1100x1200mm	10
15	14	Tablettblech B	Tray sheet B.ipt	Production	0,7 mm dickes gewelltes Blech 1200x100 mm	11
16	14	Ablageblech C	Tray sheet C.ipt	Production	0,7 mm dickes gewelltes Blech 1100x100 mm	12
17	16	Nägel lang	-	Buy	Stahlnägel 3,1x75mm	-
18	36	Nägel kurz	-	Buy	Stahlnägel 1,4x25mm	-

PROJEKT		ERSTELLT VON		GENEHMIGT VON		DATE		VERSION	
Fischtrockner Smoker		J. Zeron		A. Morillo		09/08/2021		1.0	
TEIL-NAME			DATEI-NAME				TEIL-CODE		
Teileliste			ilo_fds_fish-dryer_smoker.csv				B1		
ENTWICKELT VON			UMGESTALTET VON		DOK. TYP		WERKSTOFF		MENGE
					Parts list				-
International Labour Office			OHO e.V.		LIZENZ		SCALE		SEITE
					CC-BY-SA 4.0				3 /12

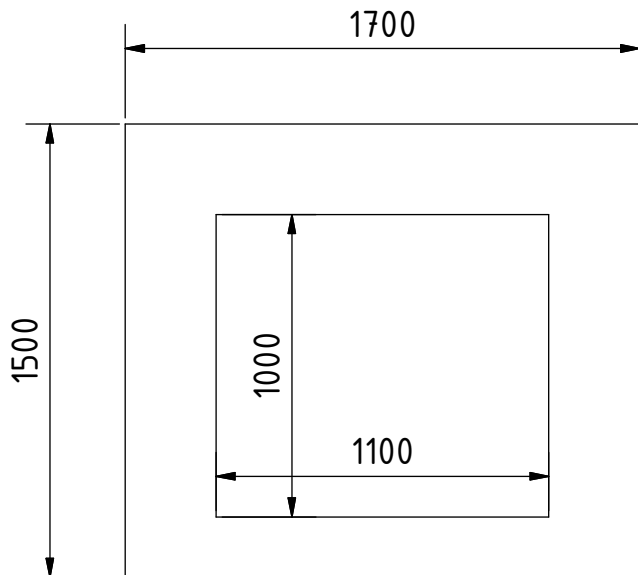
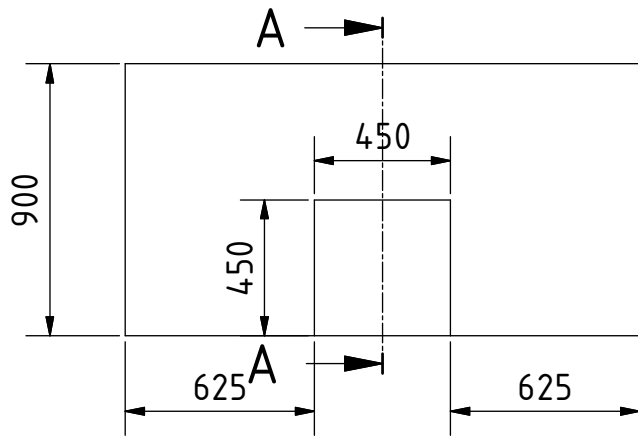

A-A ( 1 : 25 )

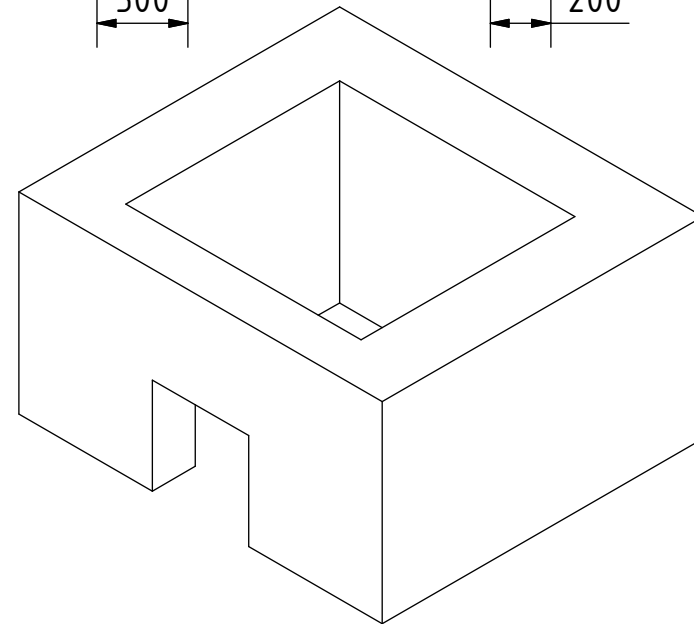
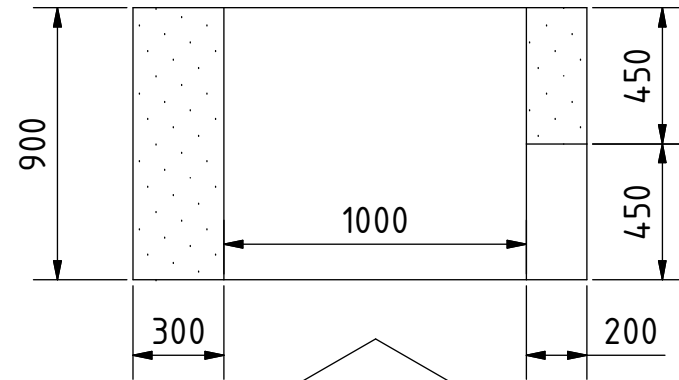

Hinweis: Alle einheiten in mm.

PROJEKT	ERSTELLT VON	GENEHMIGT VON	DATE	VERSION
Fischtrockner Smoker	J. Zeron	A. Morillo	09/08/2021	1.0
TEIL-NAME	DATEI-NAME			TEIL-CODE
Feuerbüchse	Fire box.ipt			1
ENTWICKELT VON	UMGESTALTET VON	DOK. TYP	WERKSTOFF	MENGE
		Part	Hergestellt mit Tonblöcken	1
International Labour Office	OHO e.V.	LIZENZ	SCALE	SEITE
		CC-BY-SA 4.0	1:25	4 /12

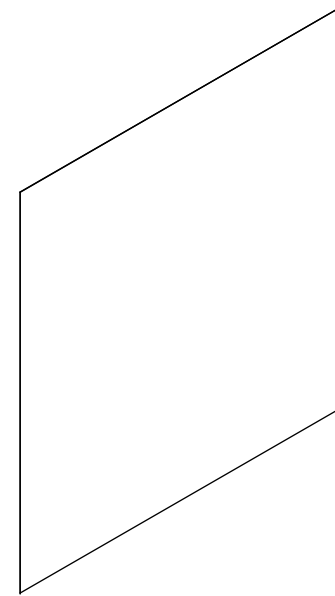
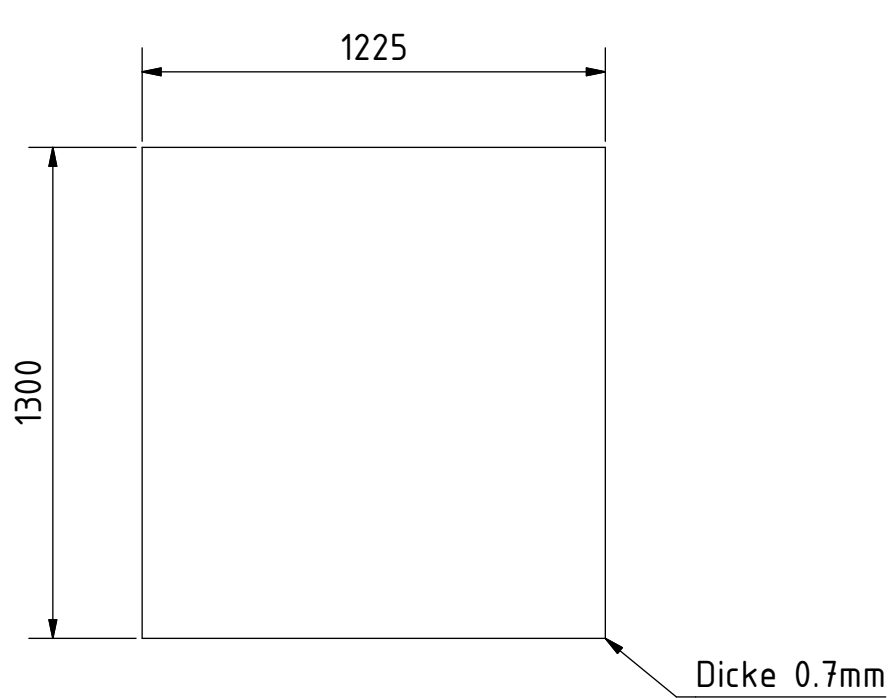

Hinweis: Alle einheiten in mm.

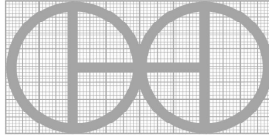
PROJEKT	ERSTELLT VON	GENEHMIGT VON	DATE	VERSION
Fischtrockner Smoker	J. Zeron	A. Morillo	09/08/2021	1.0
TEIL-NAME	DATEI-NAME			TEIL-CODE
Obere Abdeckung	Top cover.ipt			6
ENTWICKELT VON	UMGESTALTET VON	DOK. TYP	WERKSTOFF	MENGE
		Part	Gewelltes Metall	1
International Labour Office OHO e.V.		LIZENZ	SCALE	SEITE
		CC-BY-SA 4.0	1:20	5 /12

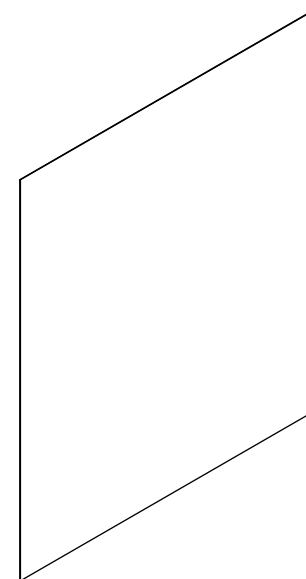
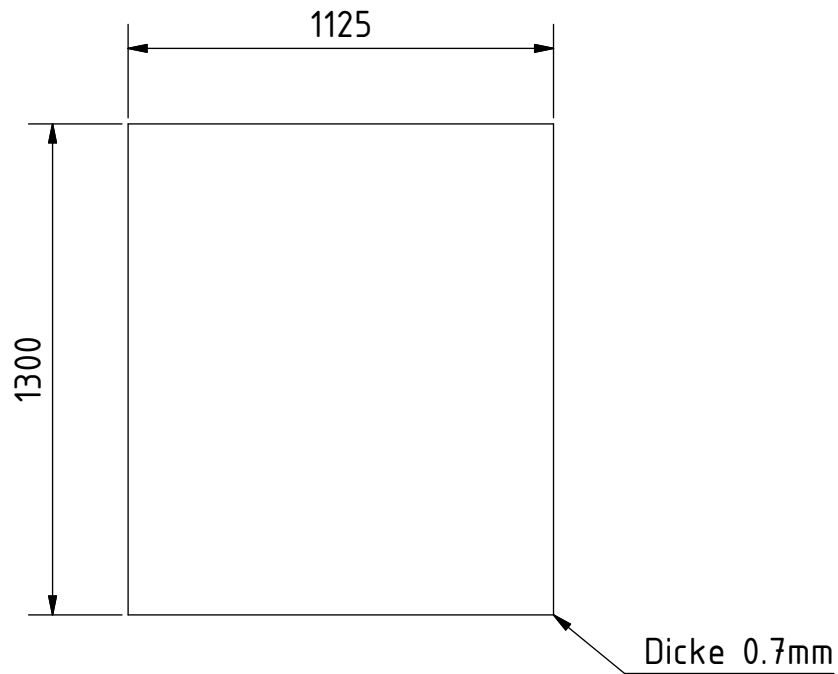

Hinweis: Alle einheiten in mm.

PROJEKT	ERSTELLT VON	GENEHMIGT VON	DATE	VERSION
Fischtrockner Smoker	J. Zeron	A. Morillo	09/08/2021	1.0
TEIL-NAME	DATEI-NAME			TEIL-CODE
Rückwand	Back cover.ipt			7
ENTWICKELT VON	UMGESTALTET VON	DOK. TYP	WERKSTOFF	MENGE
		Part	Gewelltes Metall	1
International Labour Office OHO e.V.		LIZENZ	SCALE	SEITE
		CC-BY-SA 4.0	1:20	6 /12

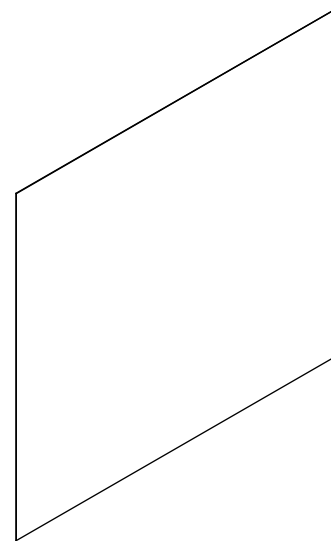
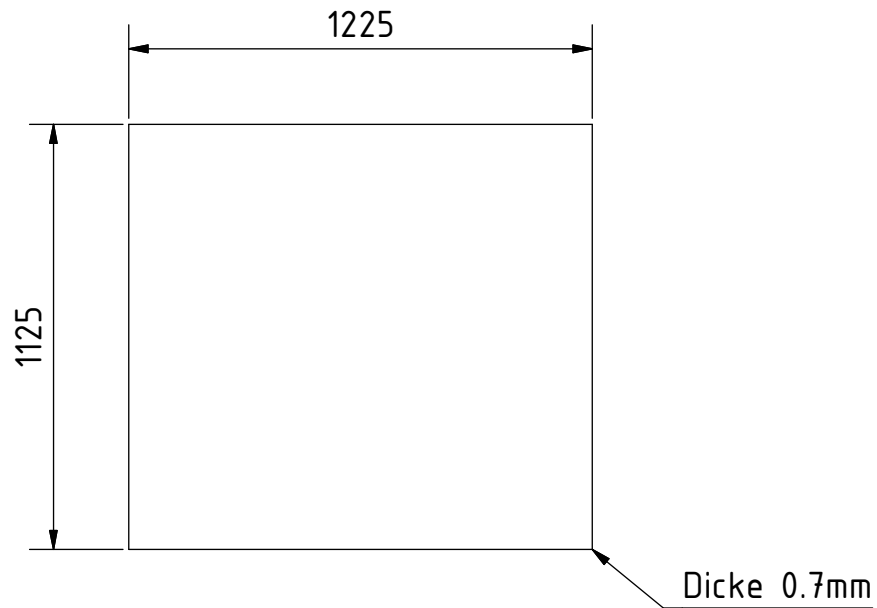

Hinweis: Alle einheiten in mm.

PROJEKT	ERSTELLT VON	GENEHMIGT VON	DATE	VERSION
Fischtrockner Smoker	J. Zeron	A. Morillo	09/08/2021	1.0
TEIL-NAME	DATEI-NAME			TEIL-CODE
Seitliche Abdeckung	Side cover.ipt			8
ENTWICKELT VON	UMGESTALTET VON	DOK. TYP	WERKSTOFF	MENGE
		Part	Gewelltes Metall	2
International Labour Office OHO e.V.		LIZENZ	SCALE	SEITE
		CC-BY-SA 4.0	1:20	7 /12

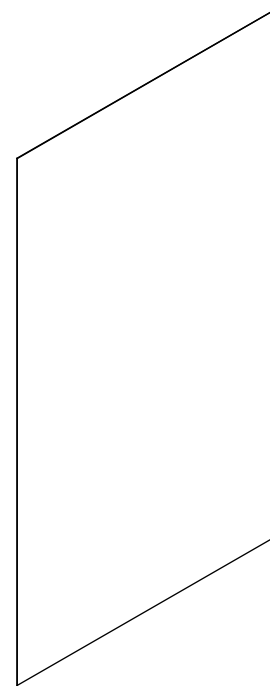
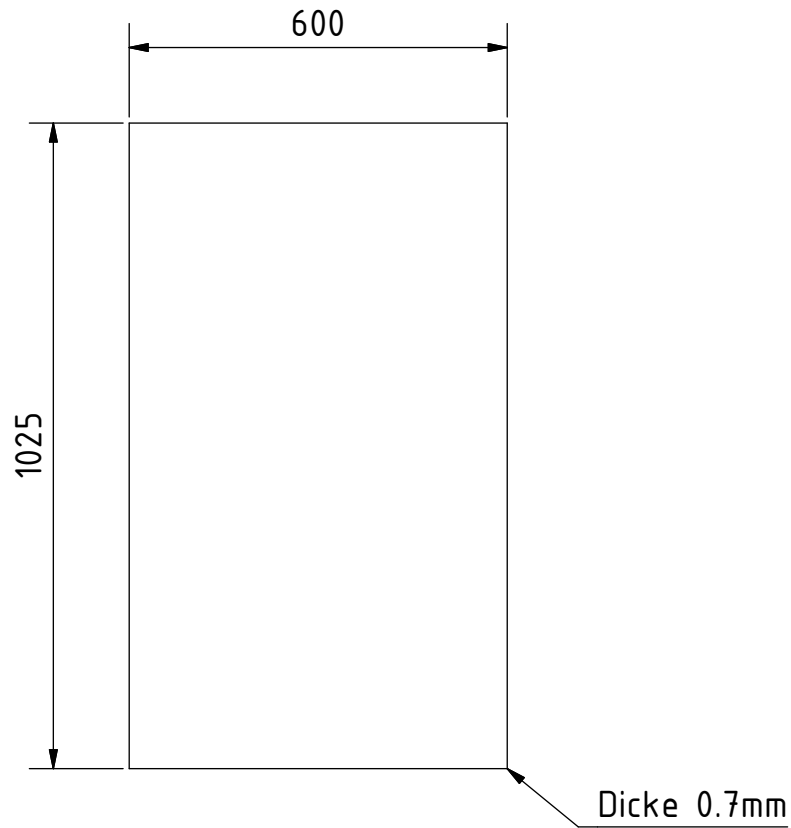

Hinweis: Alle einheiten in mm.

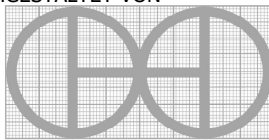
PROJEKT	ERSTELLT VON	GENEHMIGT VON	DATE	VERSION
Fischtrockner Smoker	J. Zeron	A. Morillo	09/08/2021	1.0
TEIL-NAME	DATEI-NAME			TEIL-CODE
Abdeckung der Tür	Door cover.ipt			11
ENTWICKELT VON	UMGESTALTET VON	DOK. TYP	WERKSTOFF	MENGE
		Part	Gewelltes Metall	2
International Labour Office OHO e.V.		LIZENZ	SCALE	SEITE
		CC-BY-SA 4.0	1:12	8 /12



PLAN ( 1 : 2 )

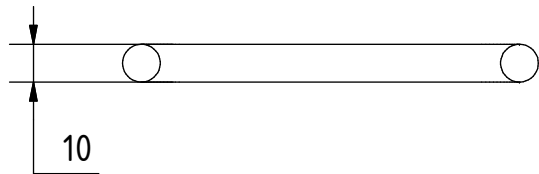
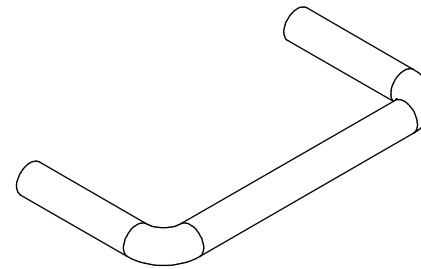
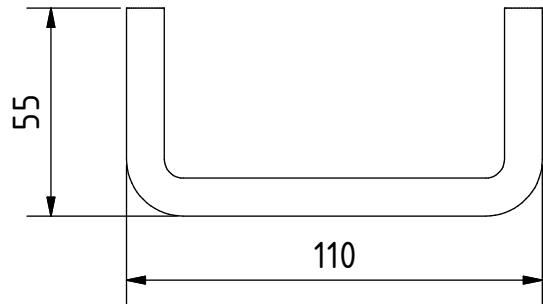

Hinweis: Alle einheiten in mm.

PROJEKT	ERSTELLT VON	GENEHMIGT VON	DATE	VERSION
Fischtrockner Smoker	J. Zeron	A. Morillo	09/08/2021	1.0
TEIL-NAME	DATEI-NAME			TEIL-CODE
Handgriff	Handle.ipt			12
ENTWICKELT VON	UMGESTALTET VON	DOK. TYP	WERKSTOFF	MENGE
		Part	Stahl A36	16
International Labour Office	OHO e.V.	LIZENZ	SCALE	SEITE
		CC-BY-SA 4.0	1:2	9 /12

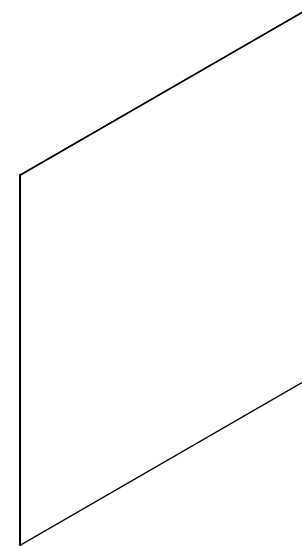
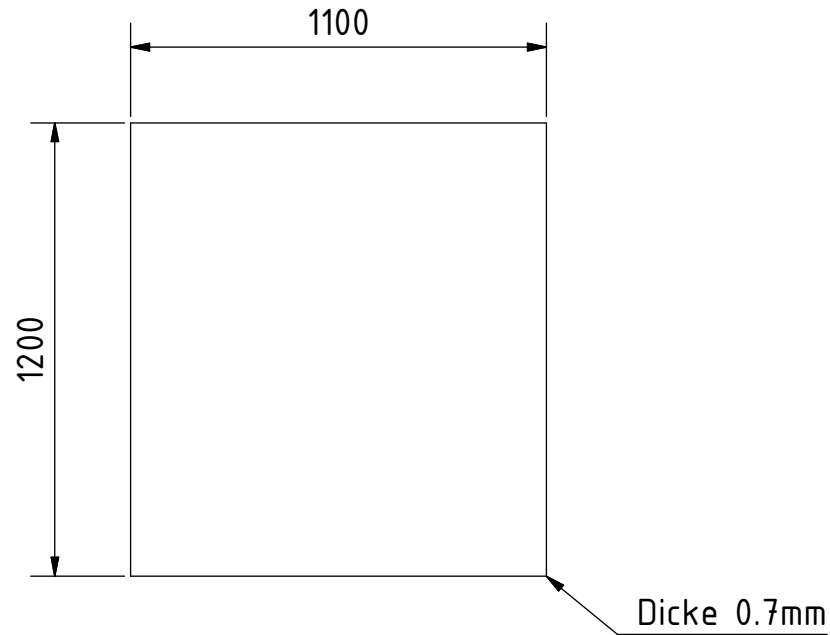

Hinweis: Alle einheiten in mm.

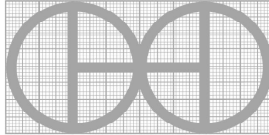
PROJEKT	ERSTELLT VON	GENEHMIGT VON	DATE	VERSION
Fischtrockner Smoker	J. Zeron	A. Morillo	09/08/2021	1.0
TEIL-NAME	DATEI-NAME			TEIL-CODE
Ablageblech A	Tray sheet A.ipt			14
ENTWICKELT VON	UMGESTALTET VON	DOK. TYP	WERKSTOFF	MENGE
		Part	Gewelltes Metall	7
International Labour Office OHO e.V.		LIZENZ	SCALE	SEITE
		CC-BY-SA 4.0	1:20	10 /12

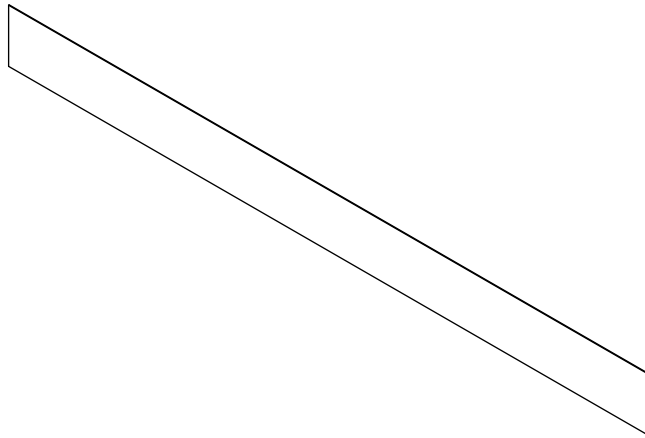
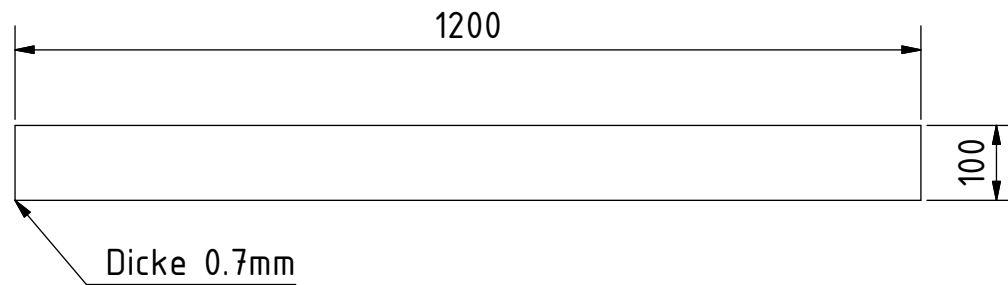

Hinweis: Alle einheiten in mm.

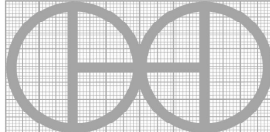
PROJEKT	ERSTELLT VON	GENEHMIGT VON	DATE	VERSION
Fischtrockner Smoker	J. Zeron	A. Morillo	09/08/2021	1.0
TEIL-NAME	DATEI-NAME			TEIL-CODE
Tablettblech B	Tray sheet B.ipt			15
ENTWICKELT VON	UMGESTALTET VON	DOK. TYP	WERKSTOFF	MENGE
		Part	Gewelltes Metall	14
International Labour Office OHO e.V.		LIZENZ	SCALE	SEITE
		CC-BY-SA 4.0	1:10	11 /12

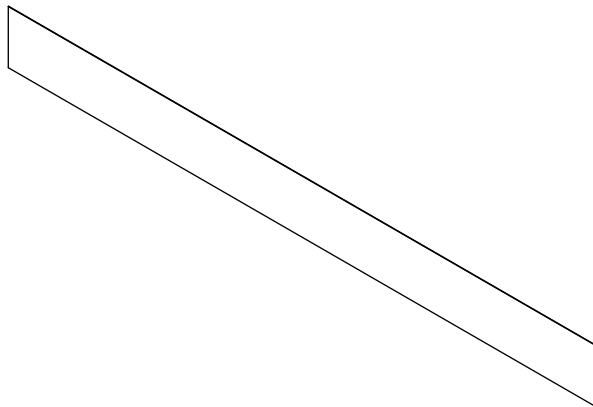
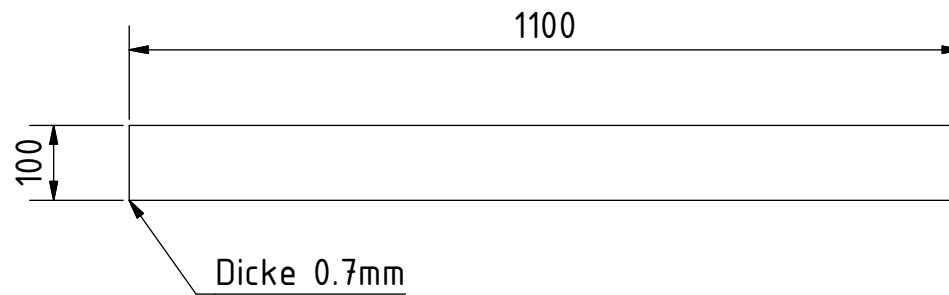

Hinweis: Alle einheiten in mm.

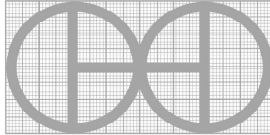
PROJEKT	ERSTELLT VON	GENEHMIGT VON	DATE	VERSION
Fischtrockner Smoker	J. Zeron	A. Morillo	09/08/2021	1.0
TEIL-NAME	DATEI-NAME			TEIL-CODE
Ablageblech C	Tray sheet C.ipt			16
ENTWICKELT VON	UMGESTALTET VON	DOK. TYP	WERKSTOFF	MENGE
		Part	Gewelltes Metall	14
International Labour Office OHO e.V.		LIZENZ	SCALE	SEITE
		CC-BY-SA 4.0	1:10	12 /12