







PROJECT		CREATED BY		APPROVED BY		DATE		VERSION	
Cross Flow Turbine		D.MOSQUERA		D. JAEGER		05-04-21		1.0	
PART NAME		FILE NAME						PART CODE	
Hatch door		oseg_cft_Hatch-door.iam						3.1.0	
DEVELOPED BY		REDESIGNED BY		SUPPORTED BY		DOC. TYPE		MATERIAL	
		 OPEN SOURCE ECOLOGY GERMANY OSEG		 <b>E.ON</b> <b>STIFTUNG</b>		ASSEMBLY			
				LICENCE		SCALE		SHEET	
				CC.BY.SA 4.0		1:4		29 /90	

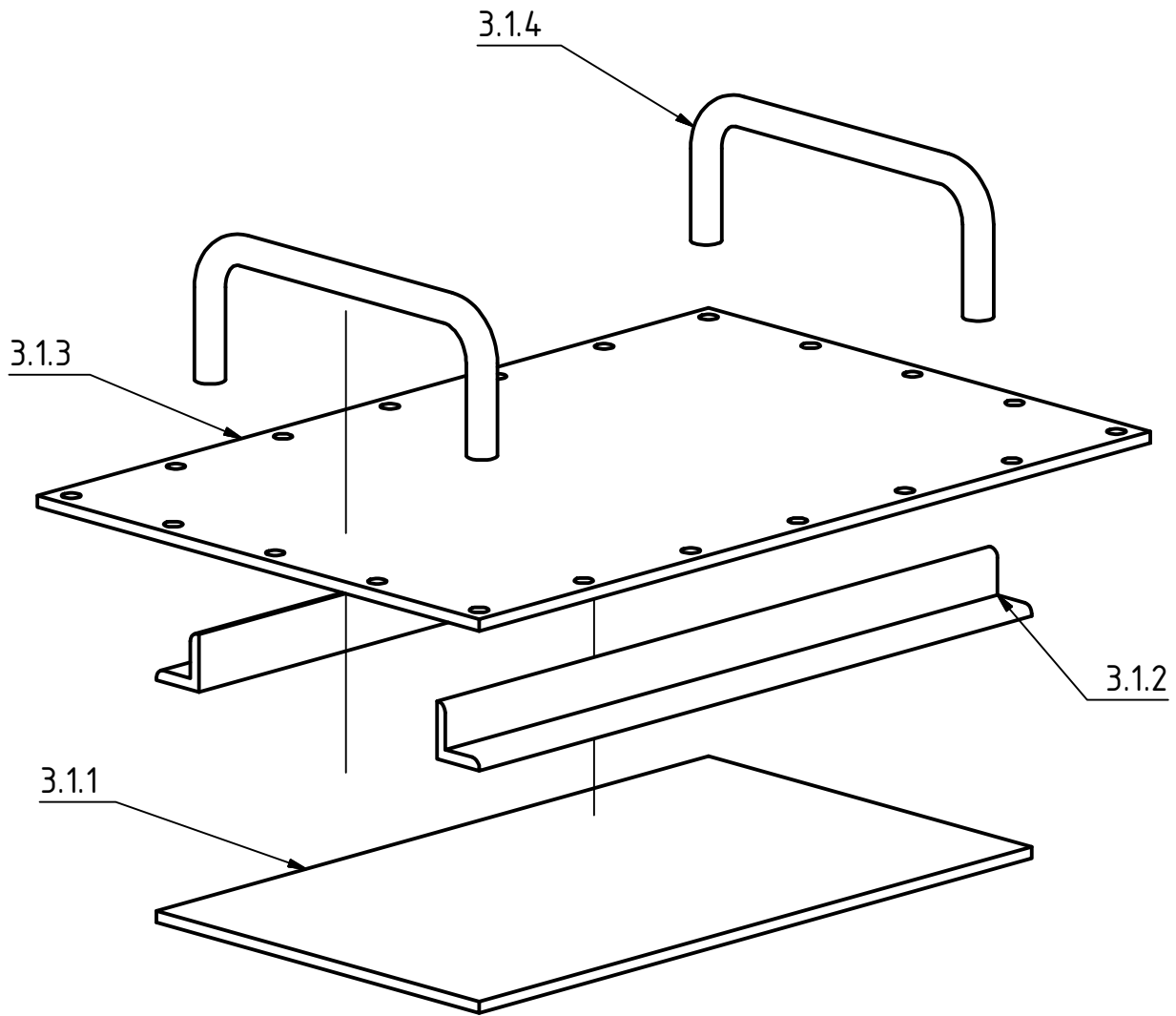

PROJECT		CREATED BY	APPROVED BY	DATE	VERSION
Cross Flow Turbine		D.MOSQUERA	D. JAEGER	05-04-21	1.0
PART NAME		FILE NAME			PART CODE
Hatch door		oseg_cft_Hatch-door.ipn			3.1.0
DEVELOPED BY	REDESIGNED BY	SUPPORTED BY	DOC. TYPE	MATERIAL	QUANTITY
			ASSEMBLY		1
			LICENCE	SCALE	SHEET
			CC.BY.SA 4.0		30 /90