

BG ( 1 : 3 )

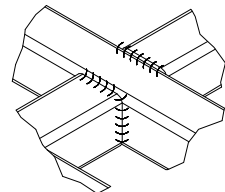

AJ ( 1 : 3 )

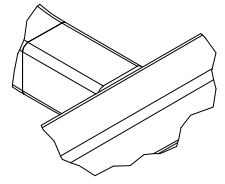

AK ( 1 : 3 )

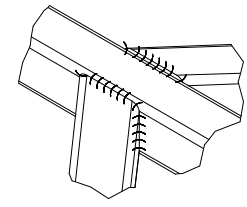

AL ( 1 : 3 )

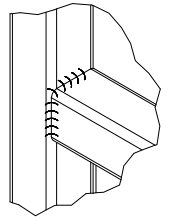

AG ( 1 : 3 )

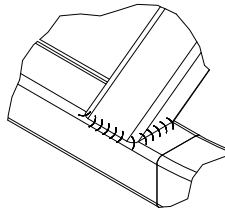

AH ( 1 : 3 )

Note: All units in mm.

PROJECT Convertible Bicycle Trailer for People - with shock absorber		CREATED BY J. Rosciano	APPROVED BY A. Morillo	DATE 26/07/2021	VERSION 1.1
PART NAME Upper frame assembly		FILE NAME Upper frame assembly.iam			POS 7.0
DEVELOPED BY Practical Action	REDESIGNED BY OHO e.V.	DOC. TYPE Assembly	MATERIAL	QUANTITY 1	
		LICENCE CC-BY-SA 4.0	SCALE 1/14	SHEET 40 /51	

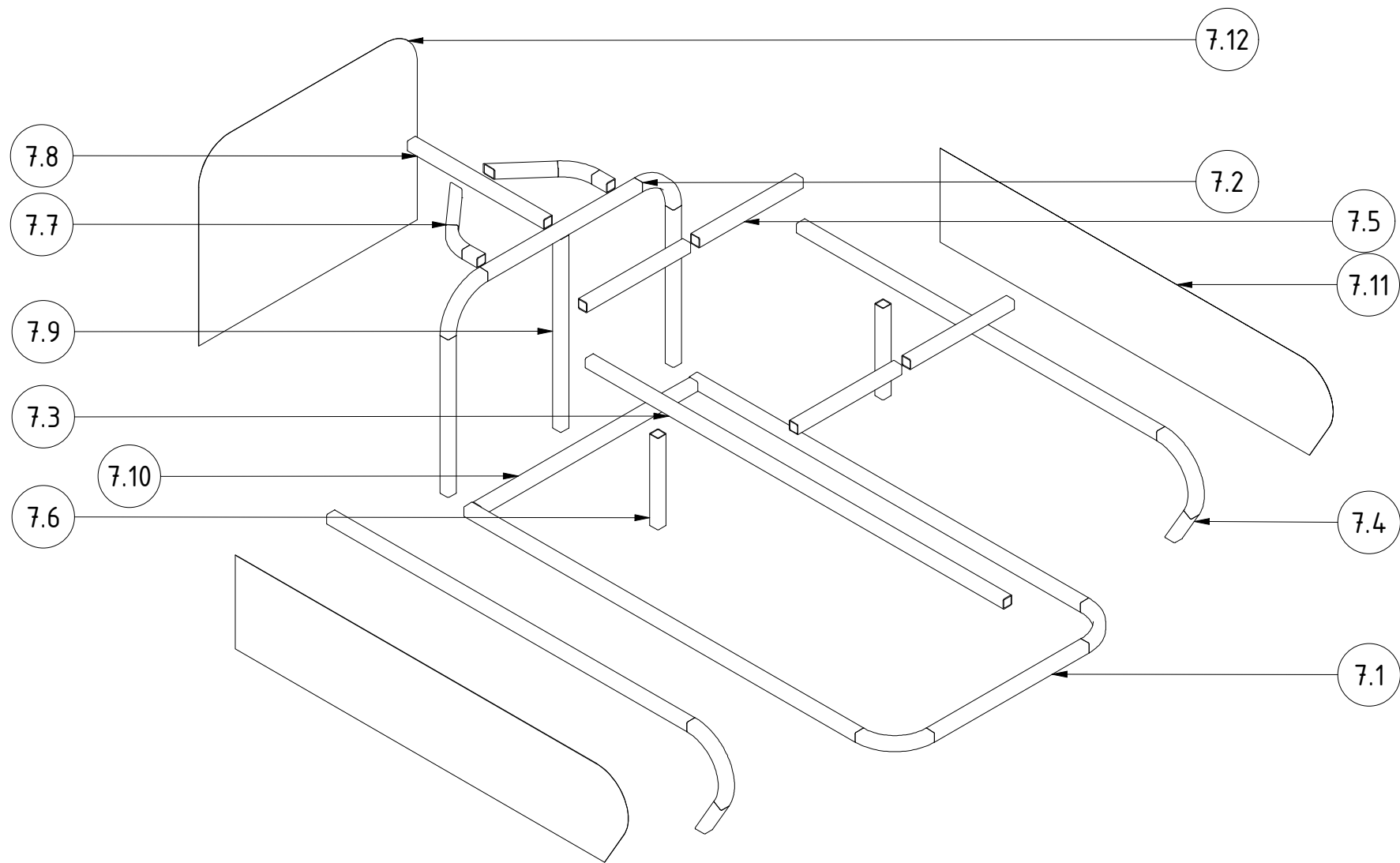

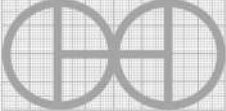
PROJECT Convertible Bicycle Trailer for People - with shock absorber		CREATED BY J. Rosciano		APPROVED BY A. Morillo		DATE 26/07/2021		VERSION 1.1	
PART NAME Upper frame assembly		FILE NAME Upper frame assembly.ipn							POS 7.0
DEVELOPED BY Practical Action		REDESIGNED BY OHO e.V.		DOC. TYPE Assembly		MATERIAL		QUANTITY 1	
				LICENCE CC-BY-SA 4.0		SCALE 1/12		SHEET 41 /51	