







PROJECT		CREATED BY		APPROVED BY		DATE		VERSION		
Cross Flow Turbine		D.MOSQUERA		D. JAEGER		05-04-21		1.0		
PART NAME		FILE NAME								PART CODE
Inlet top		oseg_cft_Inlet-top.iam								3.0.0
DEVELOPED BY		REDESIGNED BY		SUPPORTED BY		DOC. TYPE		MATERIAL		QUANTITY
		 OPEN SOURCE ECOLOGY GERMANY OSEG				ASSEMBLY LICENCE				1
						CC.BY.SA 4.0		SCALE		SHEET
								1:5		27 /90

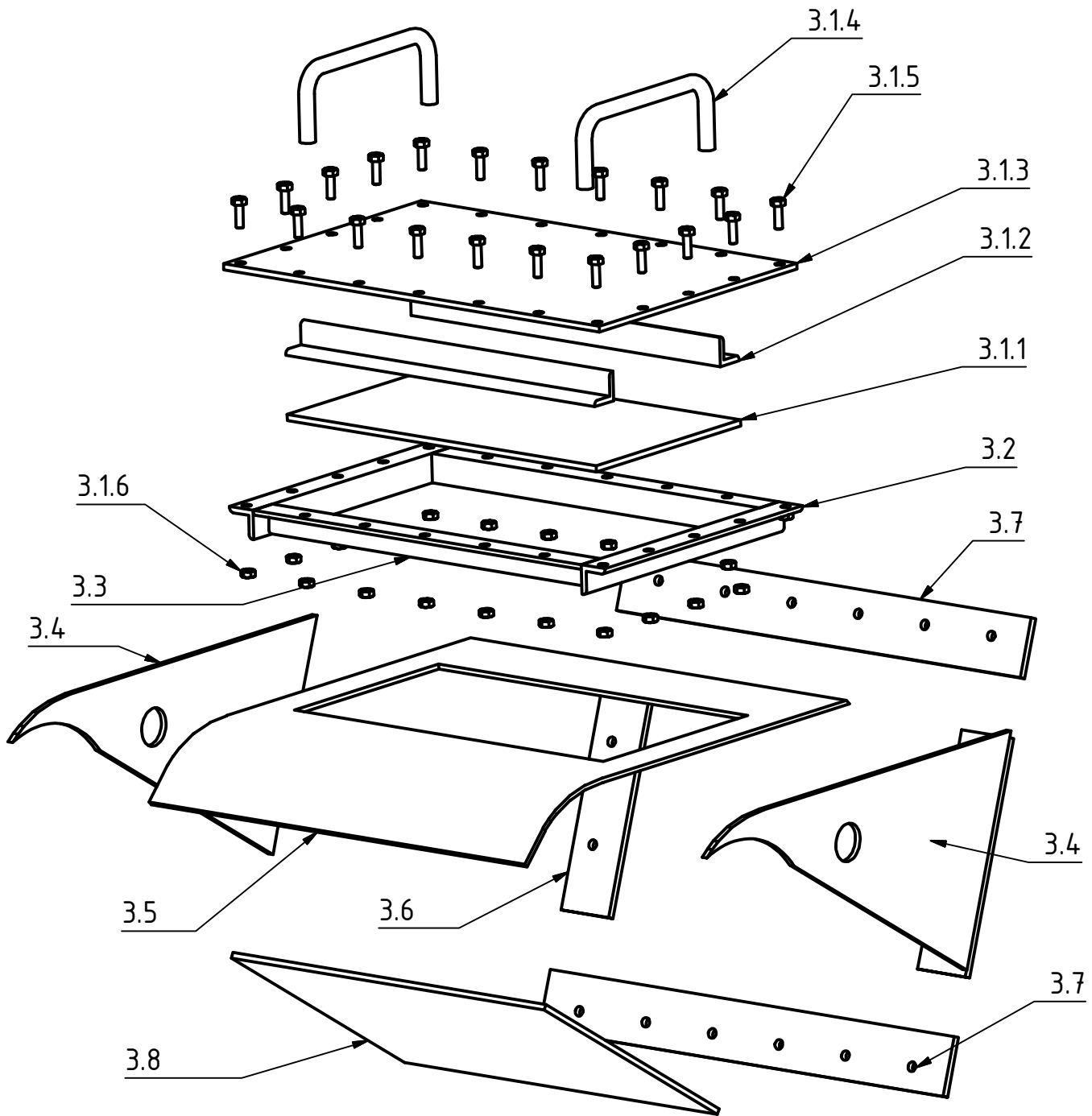

PROJECT		CREATED BY		APPROVED BY		DATE		VERSION	
Cross Flow Turbine		D.MOSQUERA		D. JAEGER		05-04-21		1.0	
PART NAME		FILE NAME						PART CODE	
Inlet top		oseg_cft_Inlet-top.ipn						3.0.0	
DEVELOPED BY		REDESIGNED BY		SUPPORTED BY		DOC. TYPE		MATERIAL	
		 OPEN SOURCE ECOLOGY GERMANY OSEG				ASSEMBLY LICENCE			
						SCALE		SHEET	
						CC.BY.SA 4.0		28 /90	