

2

1

D

D

A

A

C

C

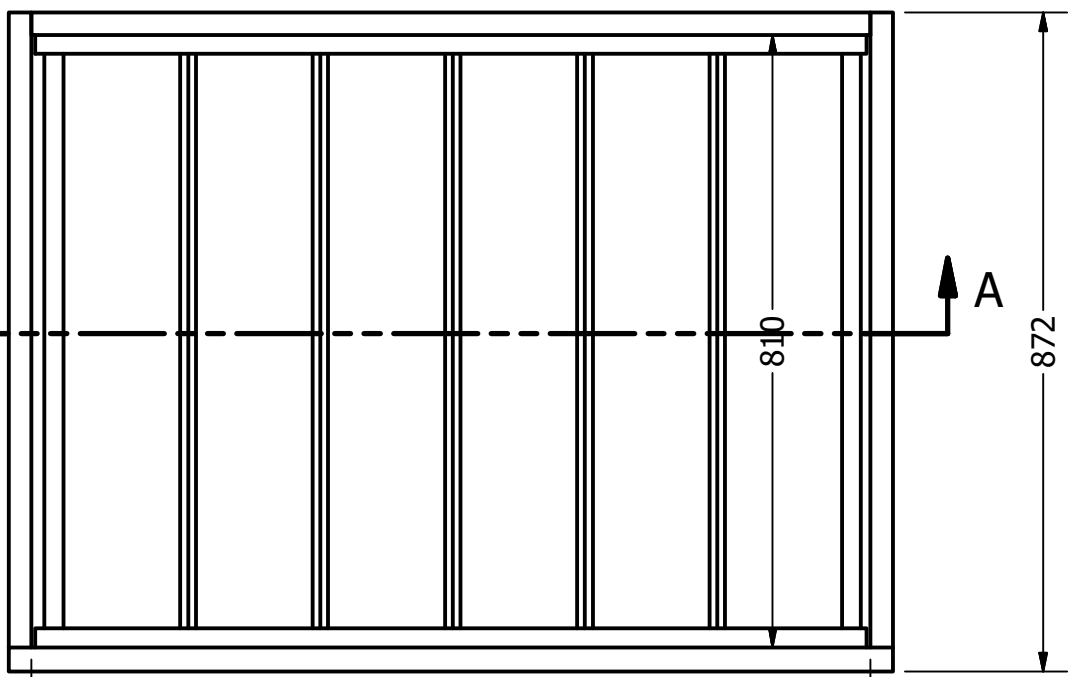

B

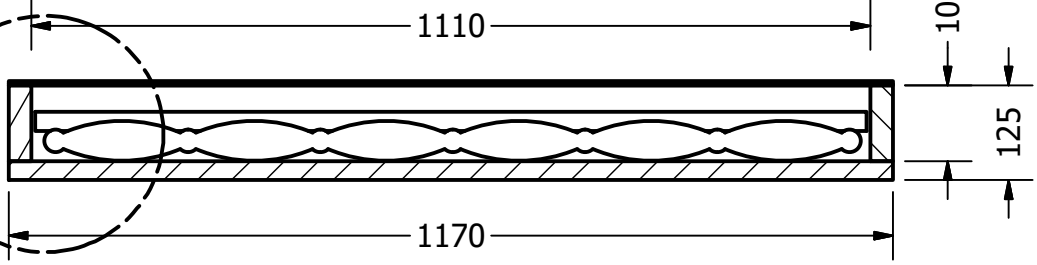

SECTION A-A

B

B

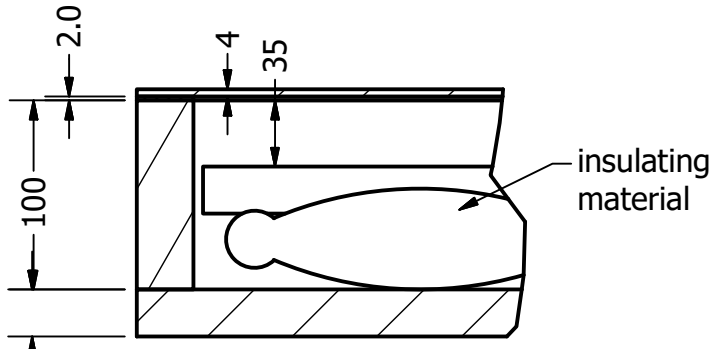

DETAIL B

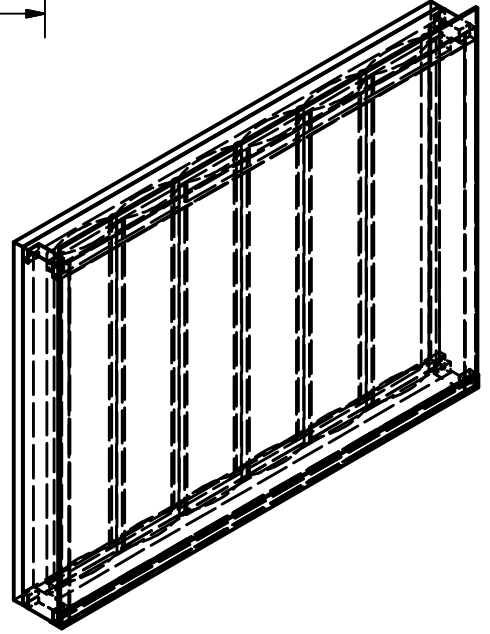

A

A

Project Zigzag Solar Water Heater		Created by D. Mosquera		Approved by D. Jeager	
Part Name collector box		Part Code 2		Document Type assembly	
Redesigned by 		Original drawing from WOT University of Twente		License CC-BY-SA	
				File Name oseg_zswh_collector-box.iam	
				Version 1.0	
				Quantity 3	
				Scale 1 / 10	
				Sheet 12	
				Date 10.02.21	

2

1



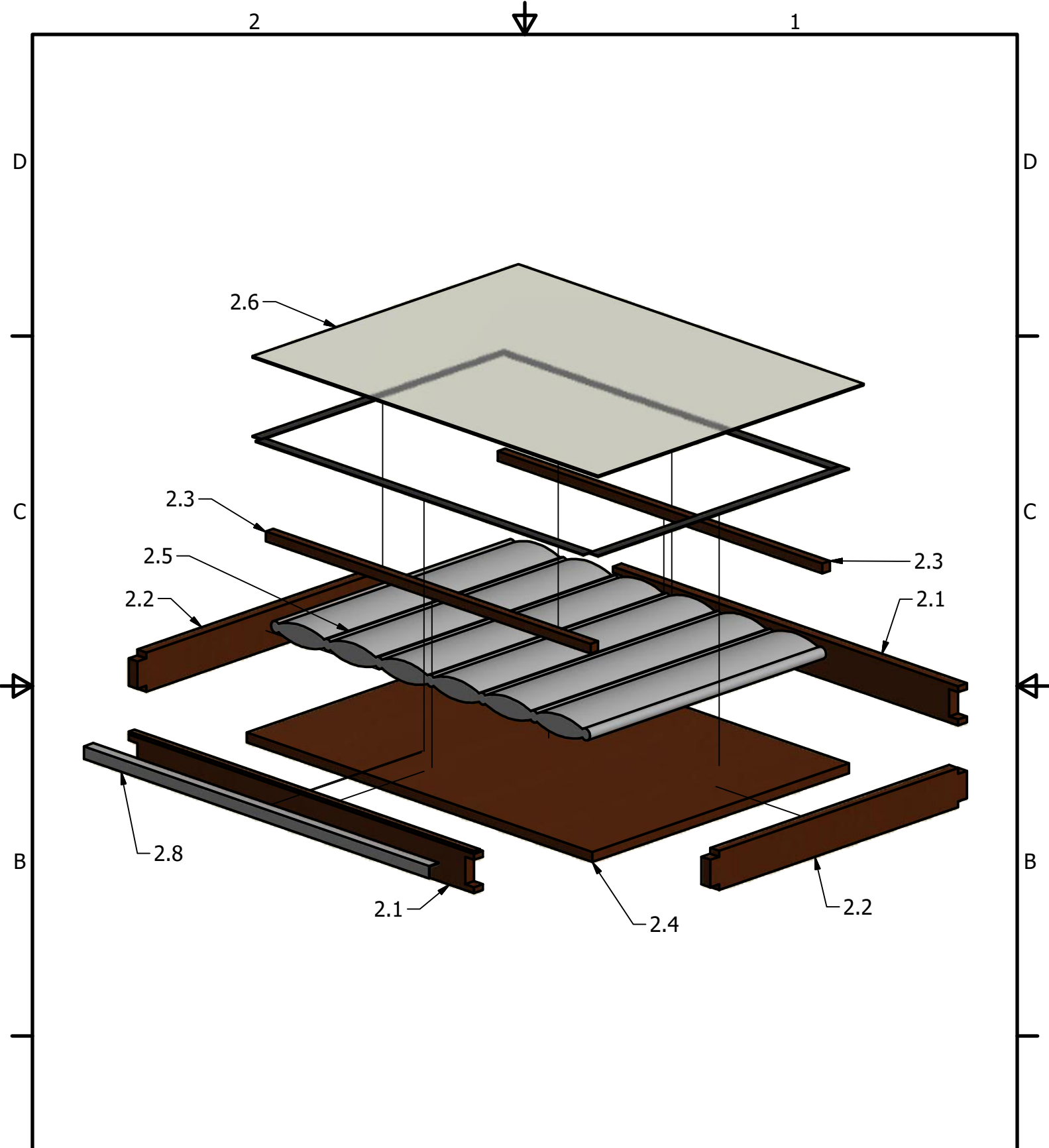

Project Zigzag Solar Water Heater		Created by D. Mosquera		Approved by D. Jeager	
Part Name collector box		Part Code 2		Document Type assembly	
Redesigned by  OPEN SOURCE ECOLOGY GERMANY		Original drawing from WOT University of Twente		License CC-BY-SA	
				File Name oseg_zswh_collector-box.iam	
				Version 1.0	
				Quantity 3	
				Scale 1 / 12	
				Sheet 13	
				Date 10.02.21	