







Project Crowd bicycle trailer		Created by D. Mosquera		Approved by D. Jeager		
Part Name Frame		Part Code 1	Document Type ASSEMBLY		Material Steel C45	
Redesigned by 	Original drawing from 	License 	File Name oseg_cbt_frame.iam		Version 1.0	Quantity 1
			Scale 1:12	Sheet 6	Date 04.12.20	

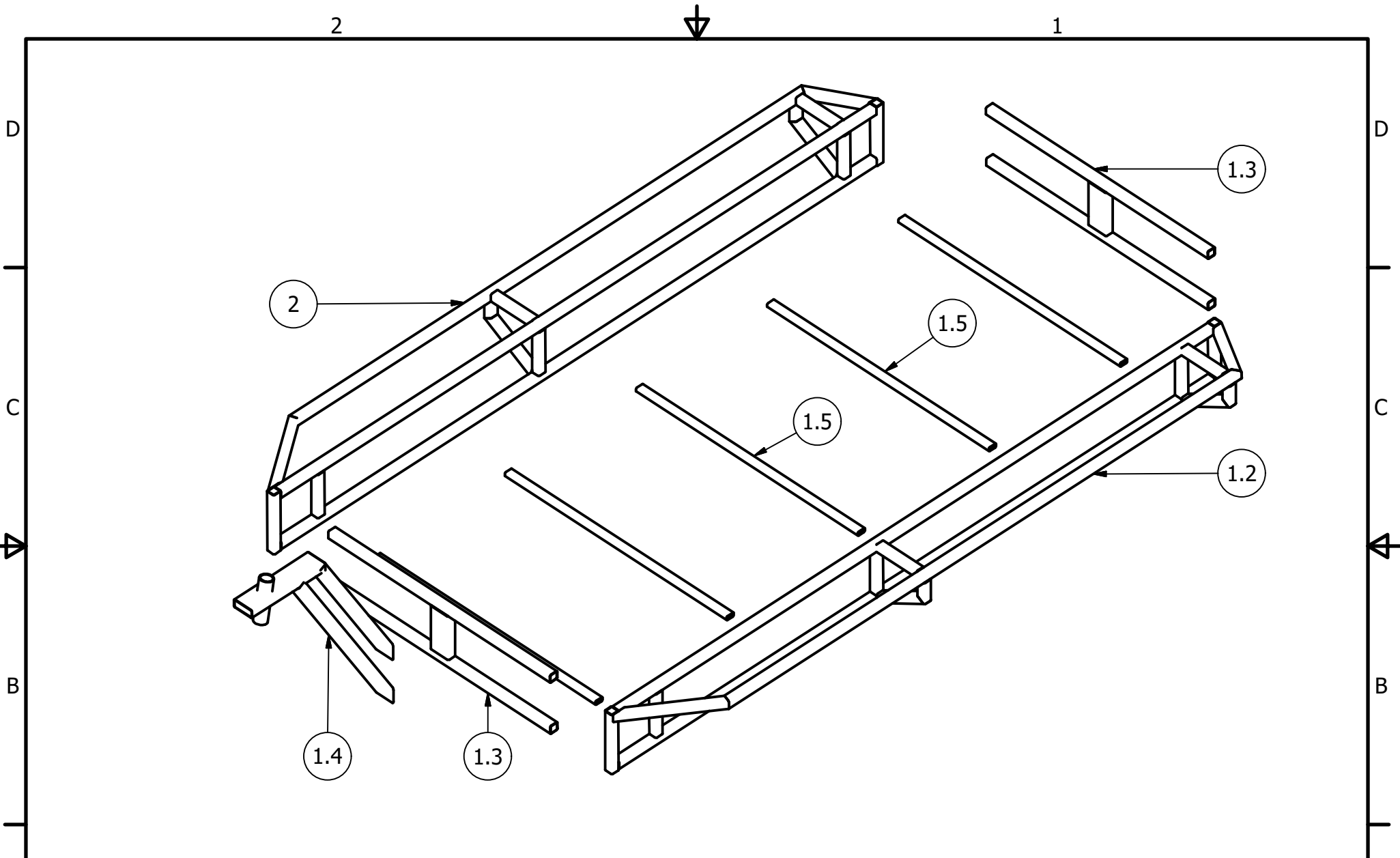

Project Crowd bicycle trailer		Created by D. Mosquera		Approved by D. Jeager	
Part Name Frame		Part Code 1	Document Type ASSEMBLY		Material Steel C45
Redesigned by  OPEN SOURCE ECOLOGY GERMANY	Original drawing from  CARPA CARRO	License 	File Name oseg_cbt_frame.ipn		Version 1.0
			Scale 1:12	Sheet 7	Date 04.12.20