







Proyect NOMBRE DE PROYECTO		Created by D. Mosquera		Approved by D. Jeager	
Part Name DESCRIPCION - PLANO CONJUNTO		Part Code A1		Document Type ASSEMBLY	
Material Steel C45		Version 1.0		Quantity	
Redesigned by 	Original drawing from 	License 	File Name oseg_cbt_A1_crowd-bicycle-trailer	Scale 1:12	Date 04.12.20
				Sheet 1	

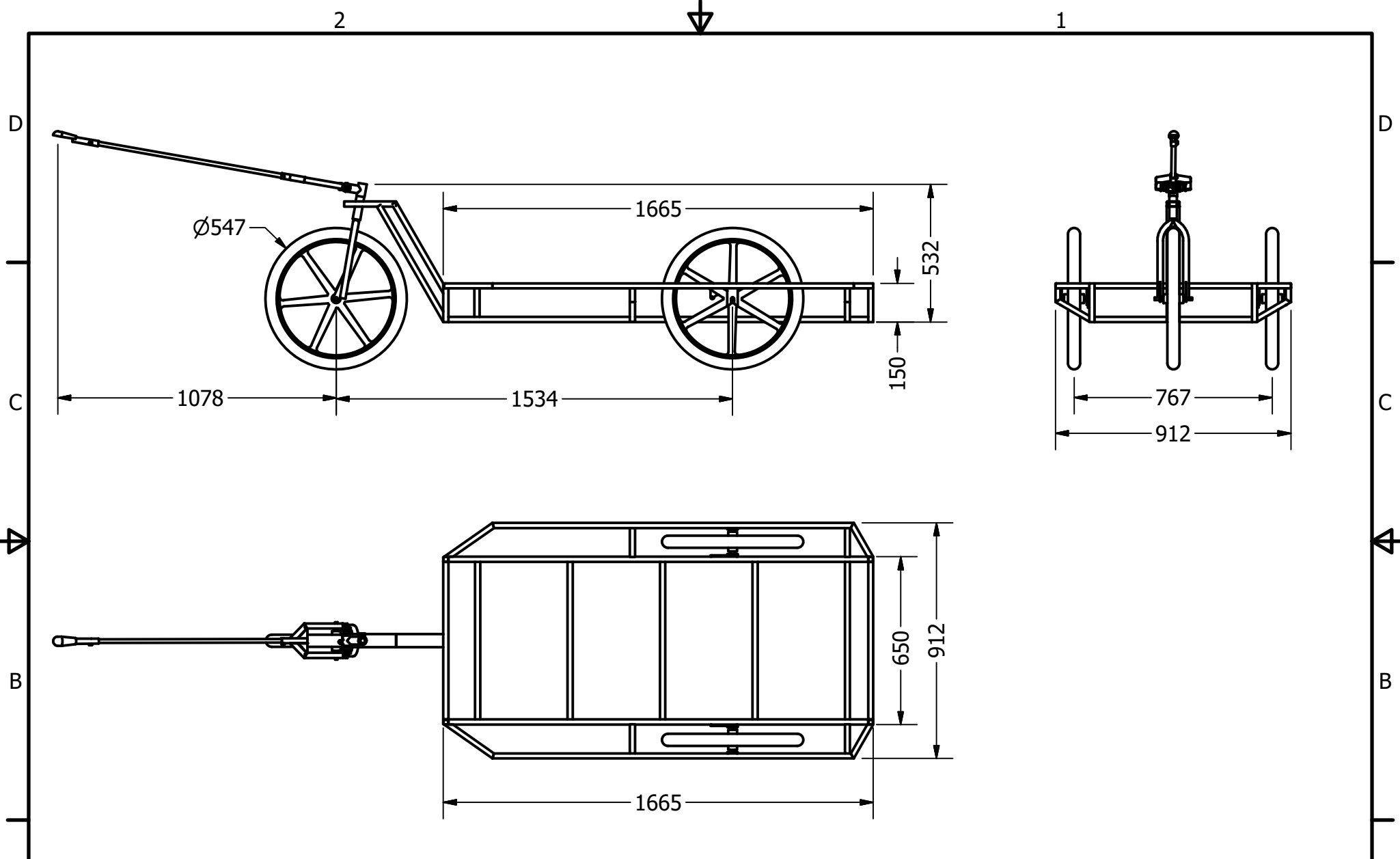

Proyect Crowd bicycle trailer		Created by D. Mosquera		Approved by D. Jeager	
Part Name Crowd-bicycle-trailer		Part Code A1		Document Type ASSEMBLY	
Redesigned by 		Original drawing from 		License 	
		File Name oseq_cbt_A1_crowd-bicycle-trailer		Material Steel C45	
		Scale 1:12		Version 1.0	
				Quantity 1	
				Date 04.12.20	

A

A

2

1