





PROJECT CUTTING SHEARS	CREATED BY A. PARDO	APPROVED BY		
PART NAME CUTTING SHEARS	PART CODE A1	DOCUMENT TYPE ASSEMBLY	MATERIAL	
 OPEN HARDWARE OBSERVATORY Free Blueprints for Sustainable Development	LICENSE 	FILE NAME CUTTING SHEARS.iam	VERSION 1.0	QUANTITY 1
		SCALE 1 : 5	SHEET 1 / 17	DATE

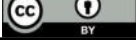
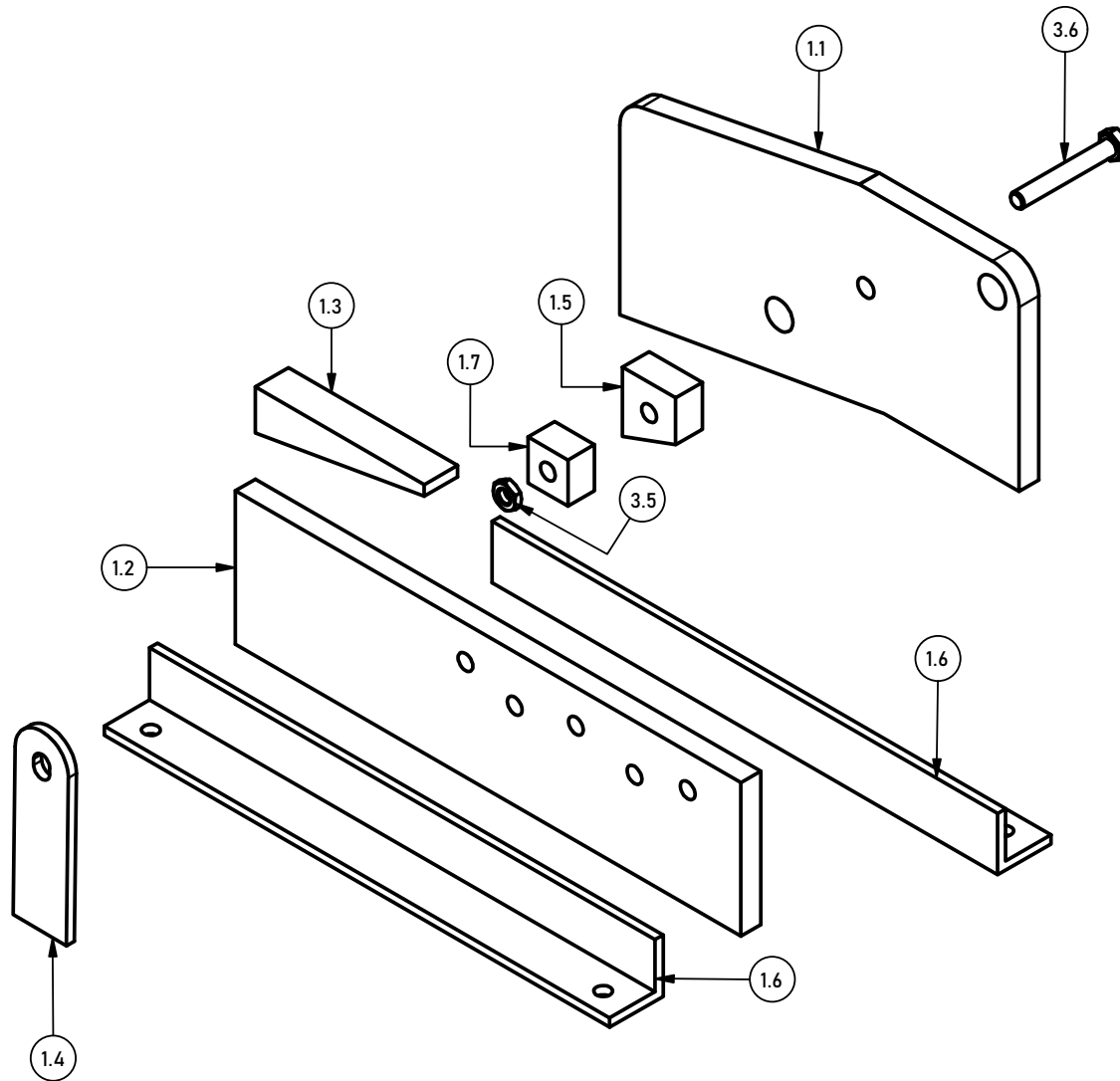

PARTS LIST						
POS.	POS. OLD	QTY	PART NAME	FILE NAME	PART TYPE	SPECIFICATIONS
A1		1	CUTTING SHEARS	CUTTING SHEARS.iam	ASSEMBLY	
B1		1	PARTS LIST	PARTS LIST	ASSEMBLY	
1		1	BODY	BODY.iam	ASSEMBLY	
1.1	A1	1	UPPER BODY	UPPER BODY.ipt	PART	
1.2	A2	1	LOWER BODY	LOWER BODY.ipt	PART	
1.3	A3	1	SPACING BLOCK	SPACING BLOCK.ipt	PART	
1.4	A9	1	DEPTH STOP	DEPTH STOP.ipt	PART	
1.5	A6	1	STOP SPACER	STOP SPACER.ipt	PART	
1.6	A4	2	MOUNTING ANGLE	MOUNTING ANGLE.ipt	PART	
1.7	A10	1	HARDEND INSERT FOR CROPPING HOLE	HARDEND INSERT FOR CROPPING HOLE.ipt	PART	
2		1	BLADE	BLADE.iam	ASSEMBLY	
2.1	B1	1	UPPER BLADE	UPPER BLADE.ipt	PART	
2.2	B2	1	LOWER BLADE	LOWER BLADE.ipt	PART	
3		1	LEVER	LEVER.iam	ASSEMBLY	
3.1	C1	1	LEVER PLATE	LEVER PLATE.ipt	PART	
3.2	C2	2	CONNECTING LINK	CONNECTING LINK.ipt	PART	
3.3	C3	1	LEVER	LEVER.ipt	PART	
3.4		2	ANSI B18.2.4.5M - M20 x 2.5	ANSI B18.2.4.5M - M20 x 2.5.ipt	PART	
3.5		7	ANSI B18.2.4.5M - M10 x 1.5	ANSI B18.2.4.5M - M10 x 1.5 - 16.ipt	PART	
3.6		7	ANSI B18.2.3.2M - M10 x 1,5	ANSI B18.2.3.2M - M10 x 1,5	PART	
3.7		2	ANSI B18.2.3.6M - M20 x 2,5 x 35	ANSI B18.2.3.6M - M20 x 2,5 x 35.ipt	PART	

PROJECT CUTTING SHEARS		CREATED BY A. PARDO	APPROVED BY		
PART NAME CUTTING SHEARS		PART CODE B1	DOCUMENT TYPE ASSEMBLY	MATERIAL STEEL METAL/ HARD STEEL	
 OPEN HARDWARE OBSERVATORY Free Blueprints for Sustainable Development		LICENSE 	FILE NAME PART LIST CUTTING SHEARS.iam	VERSION 1.0	QUANTITY 1
			SCALE	SHEET 2/17	DATE 30/9/2020



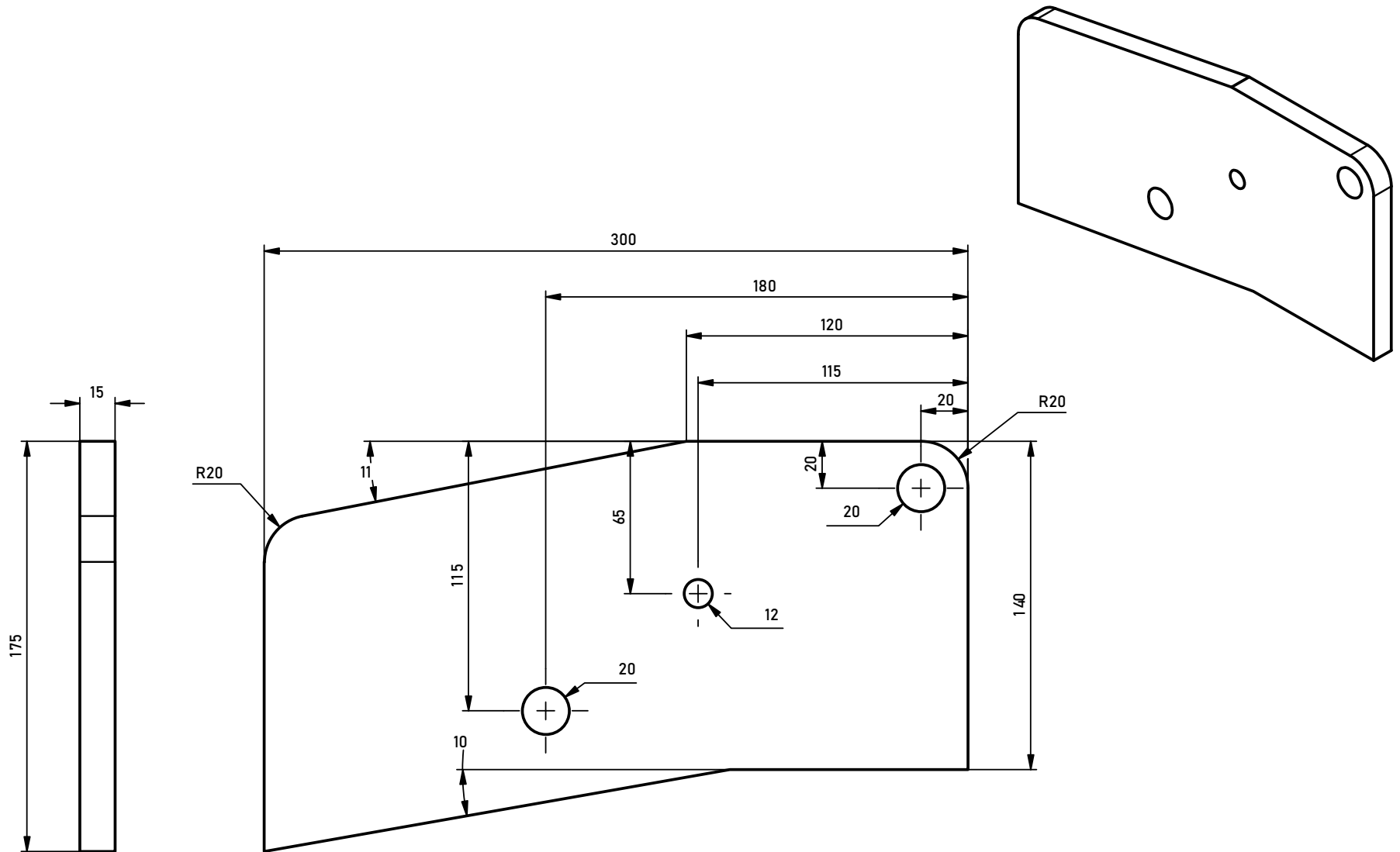

PROJECT CUTTING SHEARS	CREATED BY A. PARDO	APPROVED BY		
PART NAME BODY	PART CODE 1	DOCUMENT TYPE ASSEMBLY	MATERIAL STEEL METAL	
 OPEN HARDWARE OBSERVATORY Free Blueprints for Sustainable Development	LICENSE 	FILE NAME BODY.iam	VERSION 1.0	QUANTITY 1
		SCALE 1:4	SHEET 3/17	DATE 28/9/2020



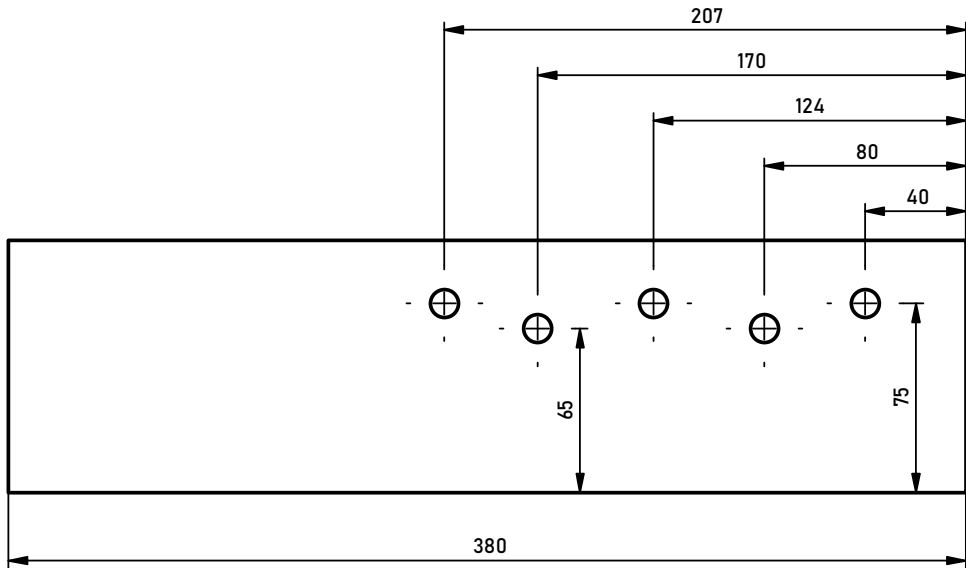
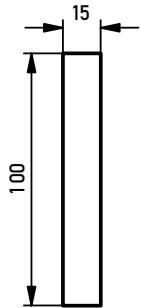
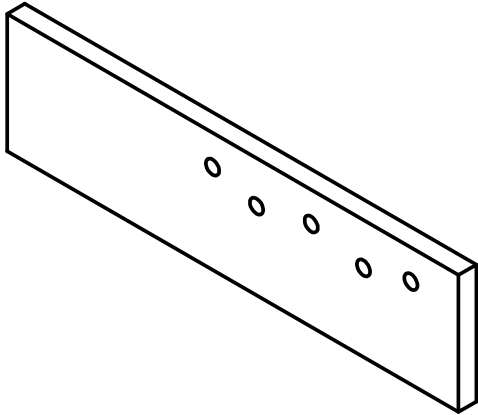

PROJECT CUTTING SHEARS	CREATED BY A. PARDO	APPROVED BY		
PART NAME UPPER BODY	PART CODE 1.1	DOCUMENT TYPE PART	MATERIAL STEEL METAL	
 OPEN HARDWARE OBSERVATORY Free Blueprints for Sustainable Development	LICENSE 	FILE NAME UPPER BODY.ipt	VERSION 1.0	QUANTITY 1
		SCALE 1 / 2.5	SHEET 4/17	DATE 24/9/2020



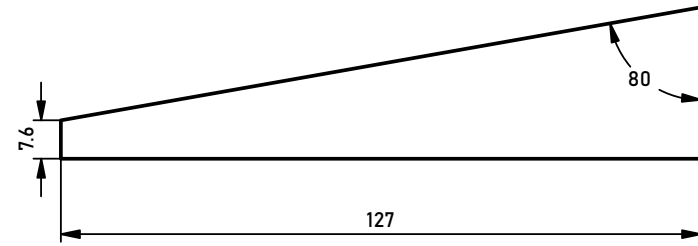
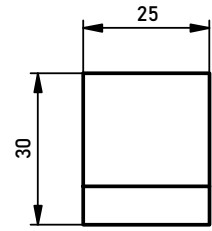
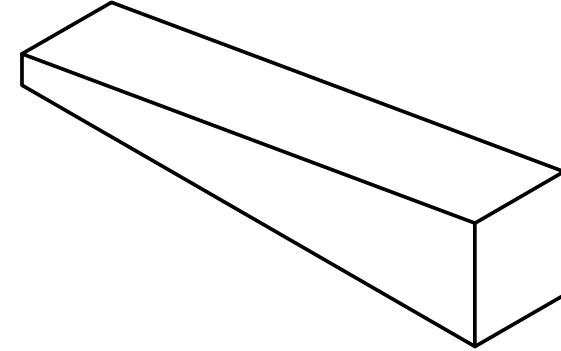

PROJECT CUTTING SHEARS		CREATED BY A. PARDO		APPROVED BY	
PART NAME LOWER BODY		PART CODE 1.2		DOCUMENT TYPE PART	MATERIAL STEEL METAL
 OPEN HARDWARE OBSERVATORY Free Blueprints for Sustainable Development		LICENSE			FILE NAME LOWER BODY.ipt
			SCALE 1 / 3	VERSION 1.0	QUANTITY 1
			SHEET 5/17	DATE 24/9/2020	



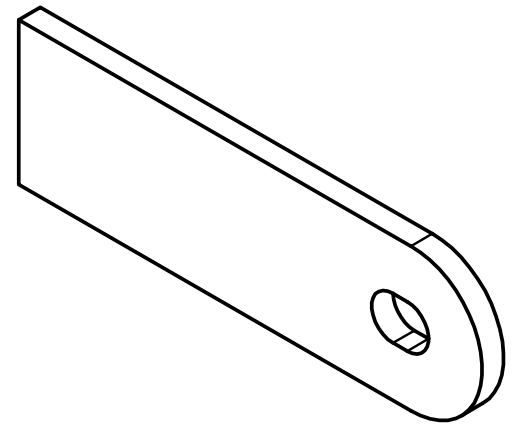
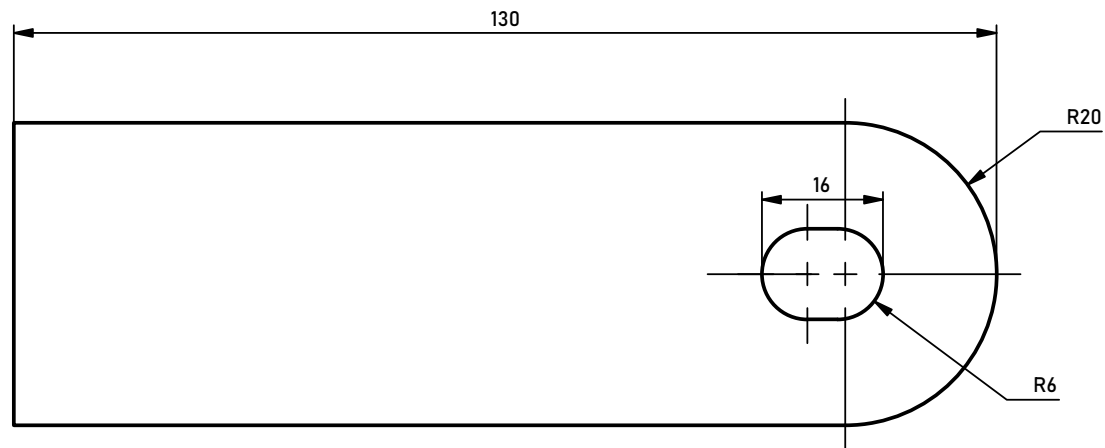
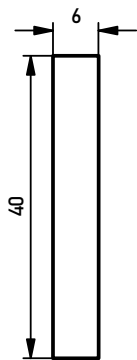

PROJECT CUTTING SHEARS		CREATED BY A. PARDO		APPROVED BY	
PART NAME SPACING BLOCK		PART CODE 1.3	DOCUMENT TYPE PART	MATERIAL STEEL METAL	
 OPEN HARDWARE OBSERVATORY Free Blueprints for Sustainable Development		LICENSE 	FILE NAME SPACING BLOCK.ipt	VERSION 1.0	QUANTITY 1
			SCALE 1:1.5	SHEET 6/17	DATE 24/9/2020



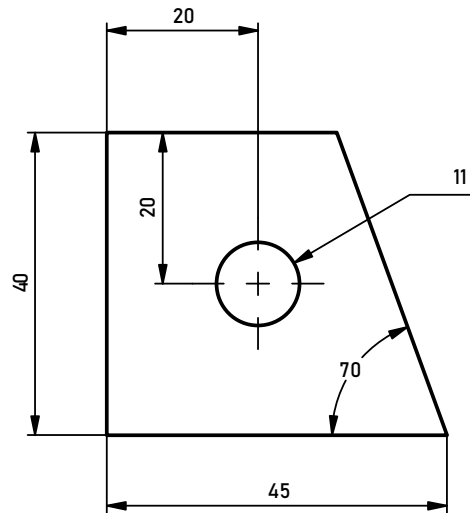
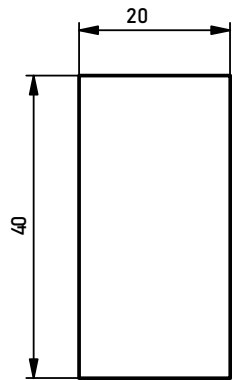
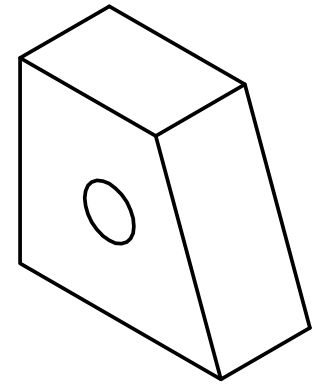

PROJECT CUTTING SHEARS	CREATED BY A. PARDO	APPROVED BY			
PART NAME DEPTH STOP	PART CODE 1.4	DOCUMENT TYPE PART	MATERIAL STEEL METAL		
 OPEN HARDWARE OBSERVATORY Free Blueprints for Sustainable Development	LICENSE 	FILE NAME DEPTH STOP.ipt	VERSION 1.0	QUANTITY 1	
		SCALE 1:1	SHEET 7/17	DATE 24/9/2020	

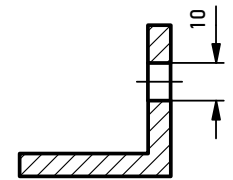
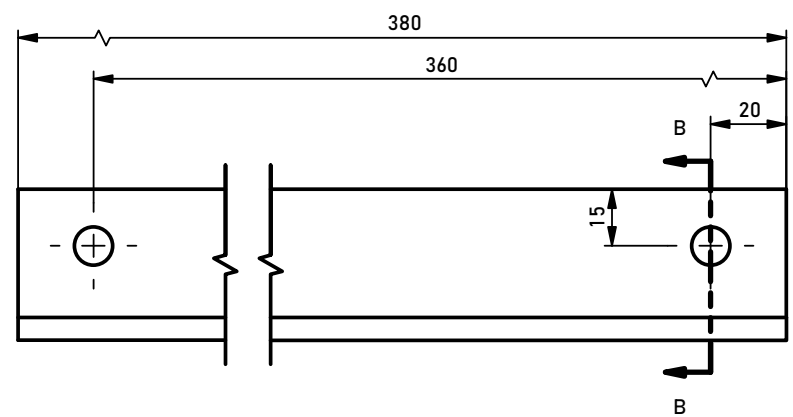
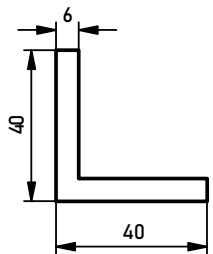
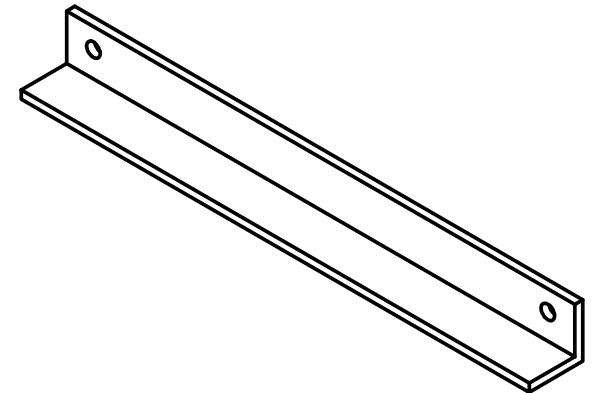

PROJECT CUTTING SHEARS	CREATED BY A. PARDO	APPROVED BY			
PART NAME STOP SPACER	PART CODE 1.5	DOCUMENT TYPE PART	MATERIAL STEEL METAL		
 OPEN HARDWARE OBSERVATORY Free Blueprints for Sustainable Development	LICENSE 	FILE NAME STOP SPACER.ipt	VERSION 1.0	QUANTITY 1	
		SCALE 1:1	SHEET 8/17	DATE 24/9/2020	





SECTION B-B
SCALE 1 / 2

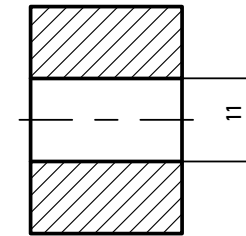
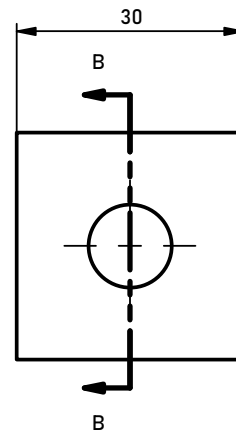
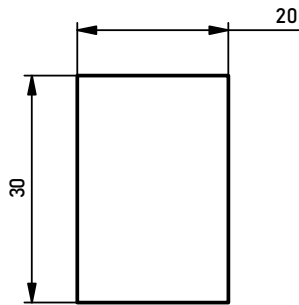
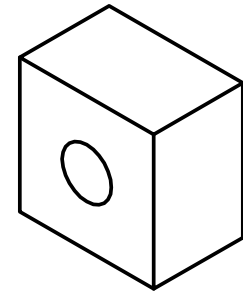

PROJECT CUTTING SHEARS		CREATED BY A. PARDO		APPROVED BY	
PART NAME MOUNTING ANGLE		PART CODE 1.6		DOCUMENT TYPE PART	
 OPEN HARDWARE OBSERVATORY Free Blueprints for Sustainable Development		LICENSE 		FILE NAME MOUNTING ANGLE.ipt	
		SCALE 1 / 2		MATERIAL STEEL METAL	
		VERSION 1.0		QUANTITY 1	
		SHEET 9/17		DATE 24/9/2020	



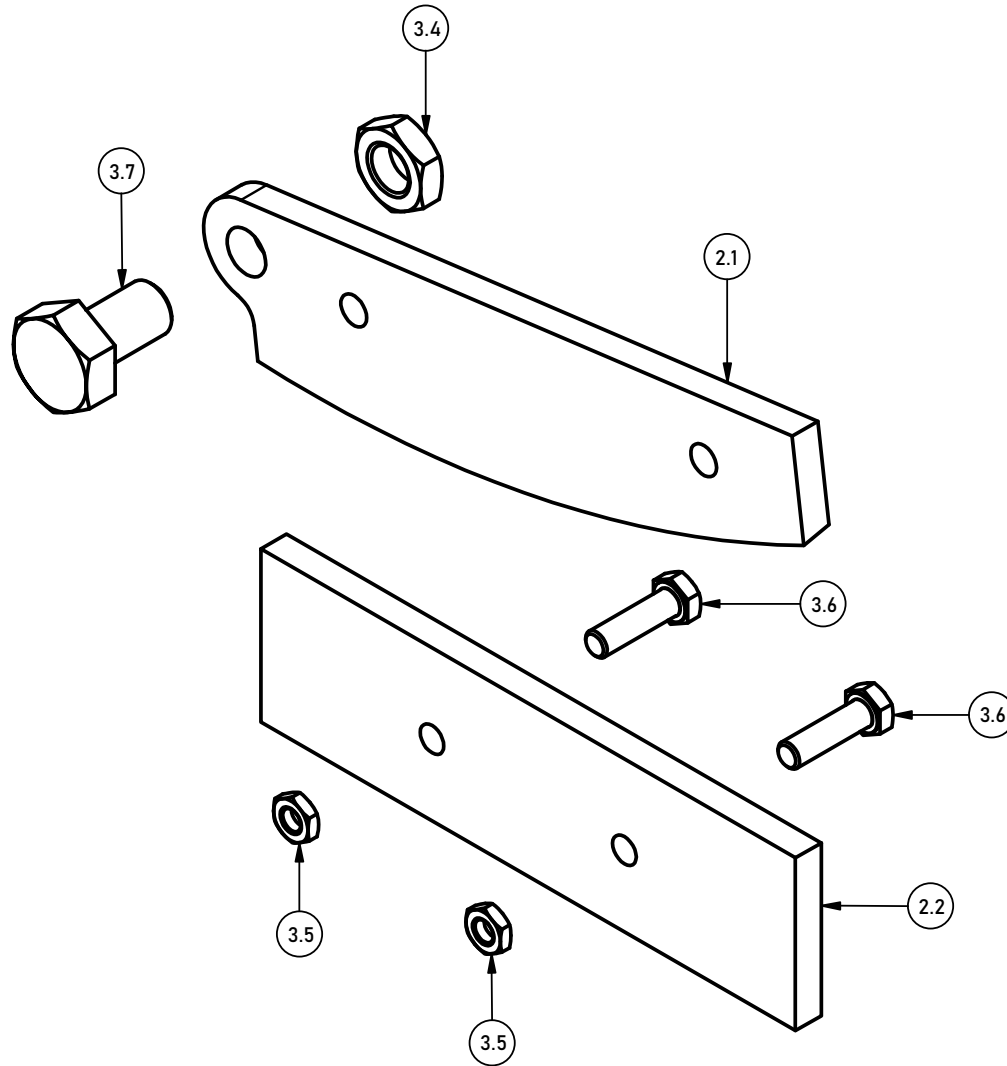

SECTION B-B
SCALE 1:1

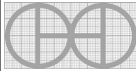
PROJECT CUTTING SHEARS		CREATED BY A. PARDO		APPROVED BY	
PART NAME HARDEND INSERT FOR CROPPING HOLE		PART CODE 1.7		DOCUMENT TYPE PART	
 OPEN HARDWARE OBSERVATORY Free Blueprints for Sustainable Development		LICENSE 		MATERIAL STEEL METAL	
		FILE NAME HARDEND INSERT FOR CROPPING HOLE.ipt		VERSION 1.0	
		SCALE 1:1		QUANTITY 1	
				SHEET 10/17	
				DATE 24/9/2020	



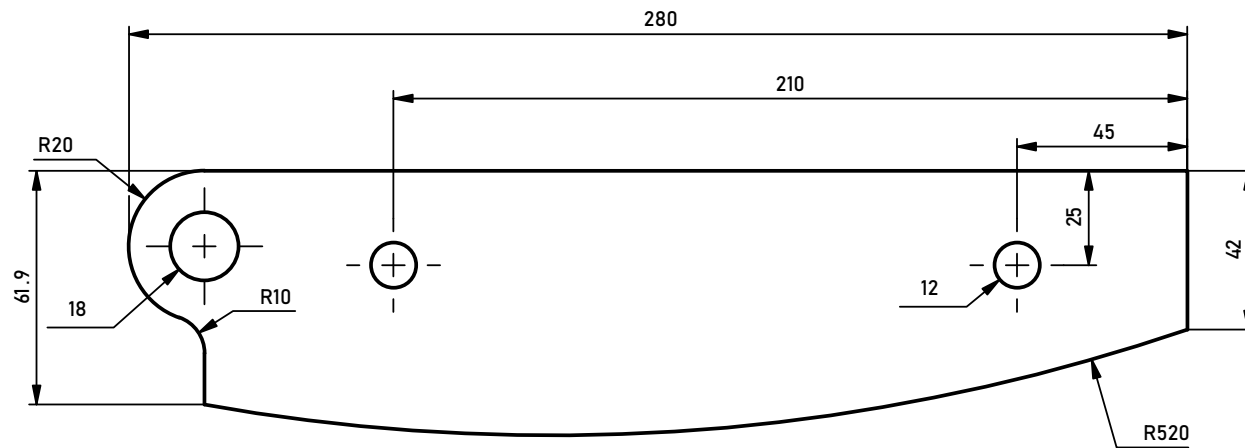
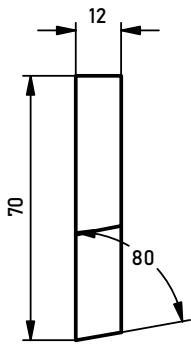
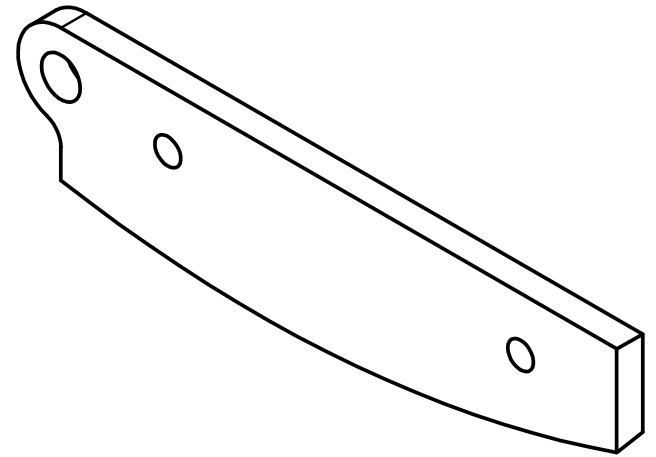

PROJECT CUTTING SHEARS	CREATED BY A. PARDO	APPROVED BY			
PART NAME BLADE	PART CODE 2	DOCUMENT TYPE ASSEMBLY	MATERIAL HARD STEEL		
 OPEN HARDWARE OBSERVATORY Free Blueprints for Sustainable Development	LICENSE 	FILE NAME BLADE.iam	VERSION 1.0	QUANTITY 1	
		SCALE 1 / 2.5	SHEET 1	DATE 24/9/2020	



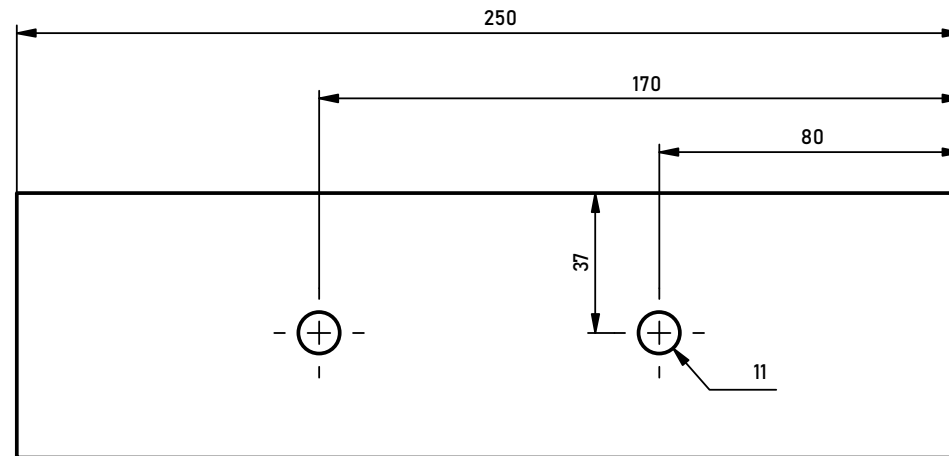
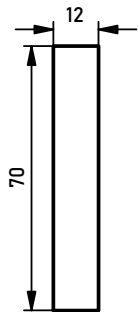
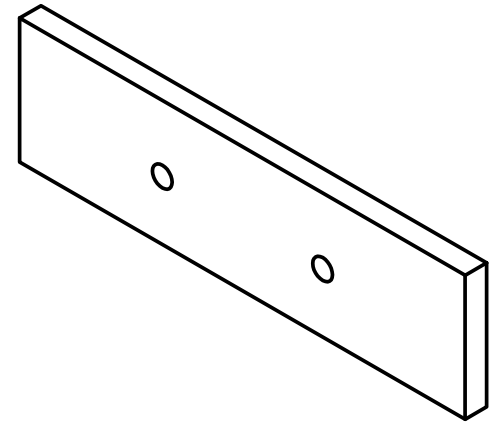

PROJECT CUTTING SHEARS	CREATED BY A. PARDO	APPROVED BY		
PART NAME UPPER BLADE	PART CODE 2.1	DOCUMENT TYPE PART	MATERIAL HARD STEEL	
 OPEN HARDWARE OBSERVATORY Free Blueprints for Sustainable Development	LICENSE 	FILE NAME UPPER BLADE.ipt	VERSION 1.0	QUANTITY 1
		SCALE 1 / 2	SHEET 12/17	DATE 24/9/2020



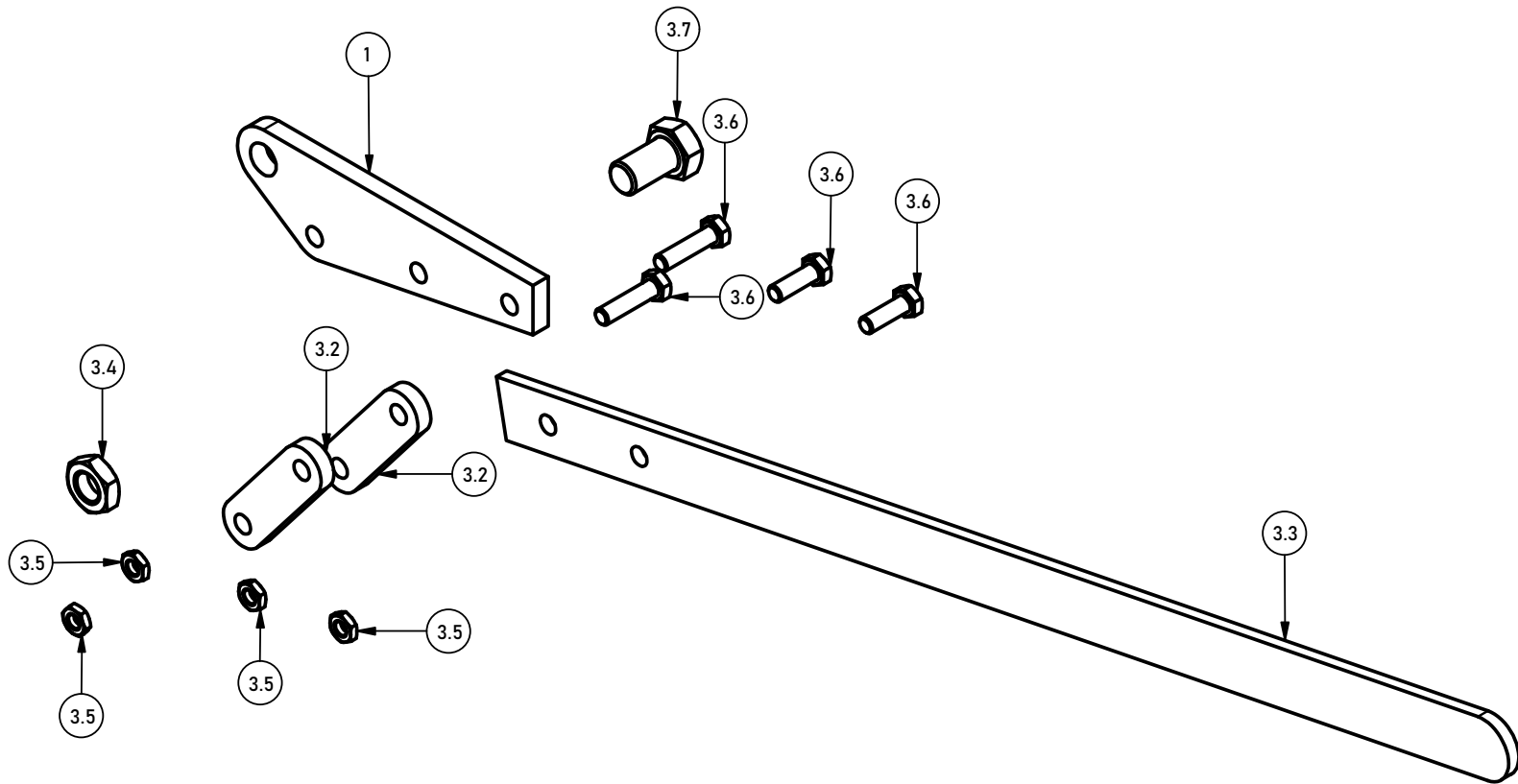

PROJECT CUTTING SHEARS	CREATED BY A. PARDO	APPROVED BY			
PART NAME LOWER BLADE	PART CODE 2.2	DOCUMENT TYPE PART	MATERIAL HARD STEEL		
 OPEN HARDWARE OBSERVATORY Free Blueprints for Sustainable Development	LICENSE 	FILE NAME LOVER BLADE.ipt	VERSION 1.0	QUANTITY 1	
		SCALE 1 / 2	SHEET 13/17	DATE 24/9/2020	



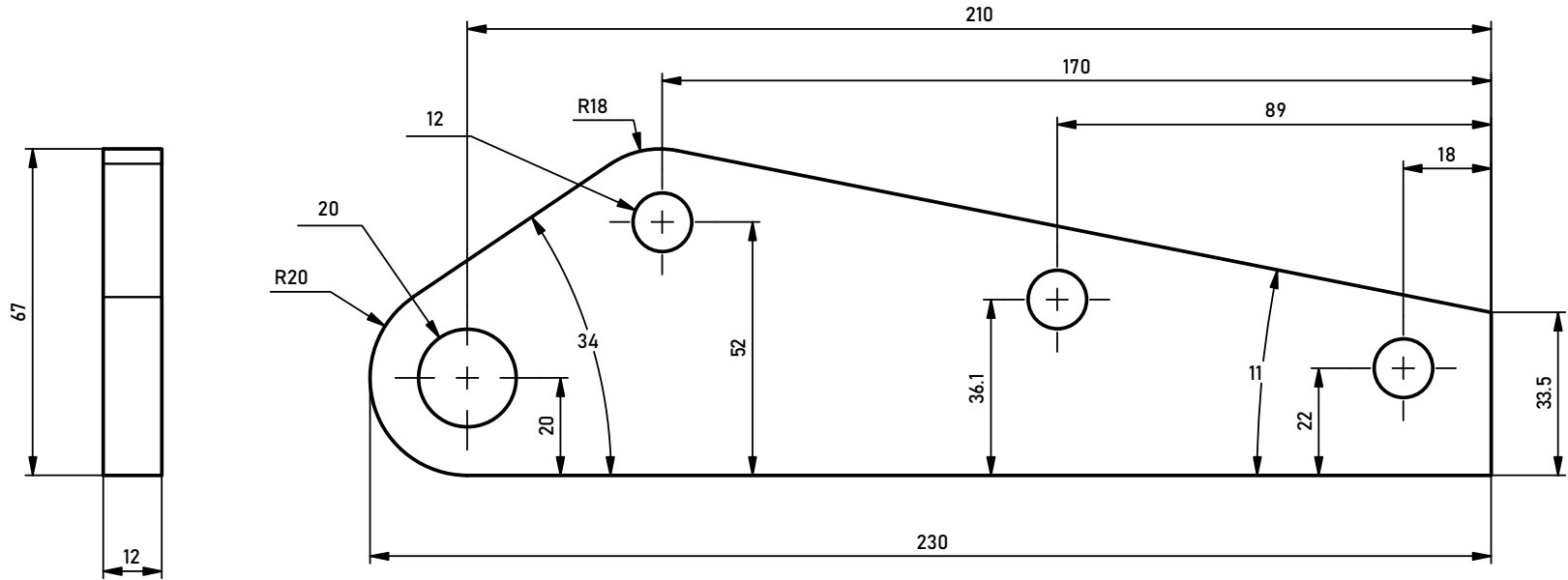
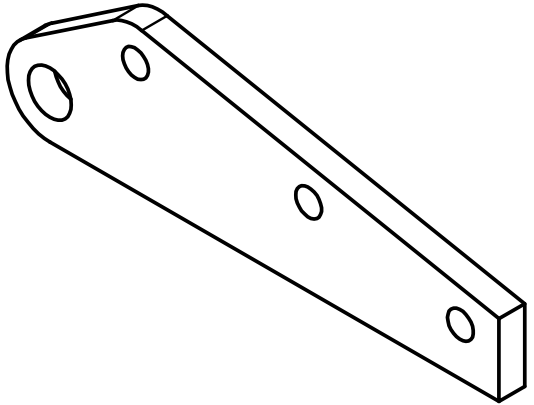

PROJECT CUTTING SHEARS	CREATED BY A. PARDO	APPROVED BY		
PART NAME LEVER	PART CODE 3	DOCUMENT TYPE ASSEMBLY	MATERIAL STEEL METAL	
 OPEN HARDWARE OBSERVATORY Free Blueprints for Sustainable Development	LICENSE 	FILE NAME LEVER.iam	VERSION 1.0	QUANTITY 1
		SCALE 1:4	SHEET 14/17	DATE 28/9/2020



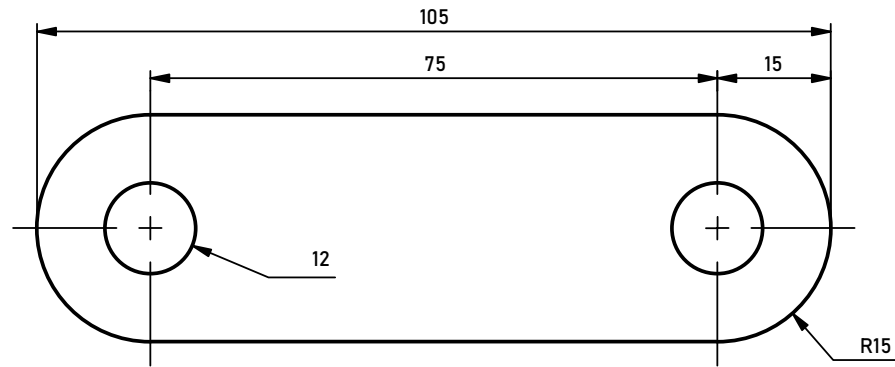
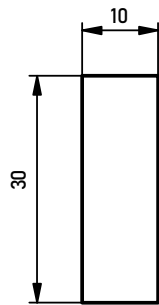
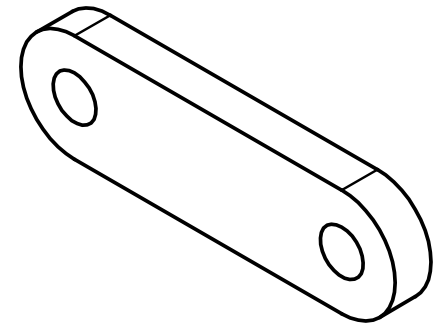

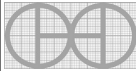
PROJECT CUTTING SHEARS		CREATED BY A. PARDO		APPROVED BY	
PART NAME LEVER PLATE		PART CODE 3.1		DOCUMENT TYPE PART	
 OPEN HARDWARE OBSERVATORY Free Blueprints for Sustainable Development		LICENSE 		MATERIAL STEEL METAL	
		FILE NAME LEVER PLATE.ipt		VERSION 1.0	
		SCALE 1 / 1.5		QUANTITY 1	
		SHEET 15/17		DATE 24/9/2020	

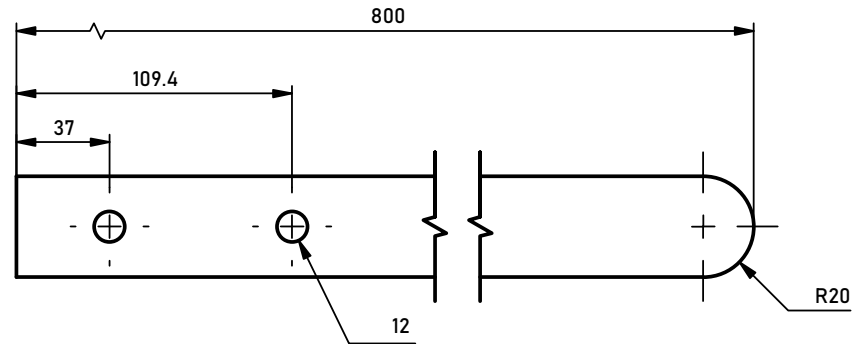
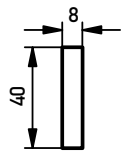
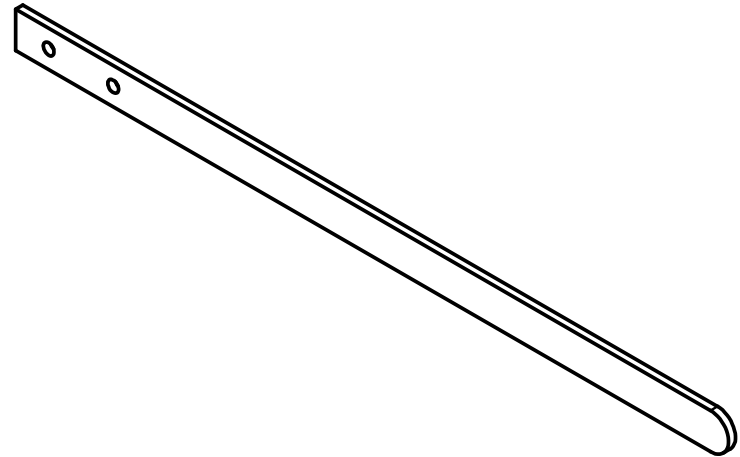

PROJECT CUTTING SHEARS	CREATED BY A. PARDO	APPROVED BY			
PART NAME CONNECTING LINK	PART CODE 3.2	DOCUMENT TYPE PART	MATERIAL STEEL METAL		
 OPEN HARDWARE OBSERVATORY Free Blueprints for Sustainable Development	LICENSE 	FILE NAME CONNECTING LINK.ipt	VERSION 1.0	QUANTITY 1	
		SCALE 1:1	SHEET 16/17	DATE 24/9/2020	



PROJECT CUTTING SHEARS	CREATED BY A. PARDO	APPROVED BY			
PART NAME LEVER	PART CODE 3.3	DOCUMENT TYPE PART	MATERIAL STEEL METAL		
 OPEN HARDWARE OBSERVATORY Free Blueprints for Sustainable Development	LICENSE 	FILE NAME LEVER.ipt	VERSION 1.0	QUANTITY 1	
		SCALE 1 / 3	SHEET 17/17	DATE 24/9/2020	