

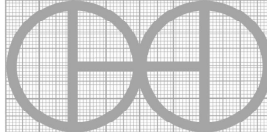

ISOMETRIC (1 : 15)

PROJEKT Sicherer und stabiler Kaninchenstall	ERSTELLT VON J. Zeron	GENEHMIGT VON A. Morillo	DATE 30/05/2021	VERSION 1.0
TEIL-NAME 3d-Ansichten	DATEI-NAME safe-and-sturdy-shelter.iam			TEIL-CODE A1
ENTWICKELT VON	UMGESTALTET VON 	DOK. TYP ASSEMBLY	WERKSTOFF	MENGE -
UNIVERSITY OF GHANA	OHO e.V.	LIZENZ CC-BY-SA 4.0	SCALE 1:15	SEITE 1 / 24

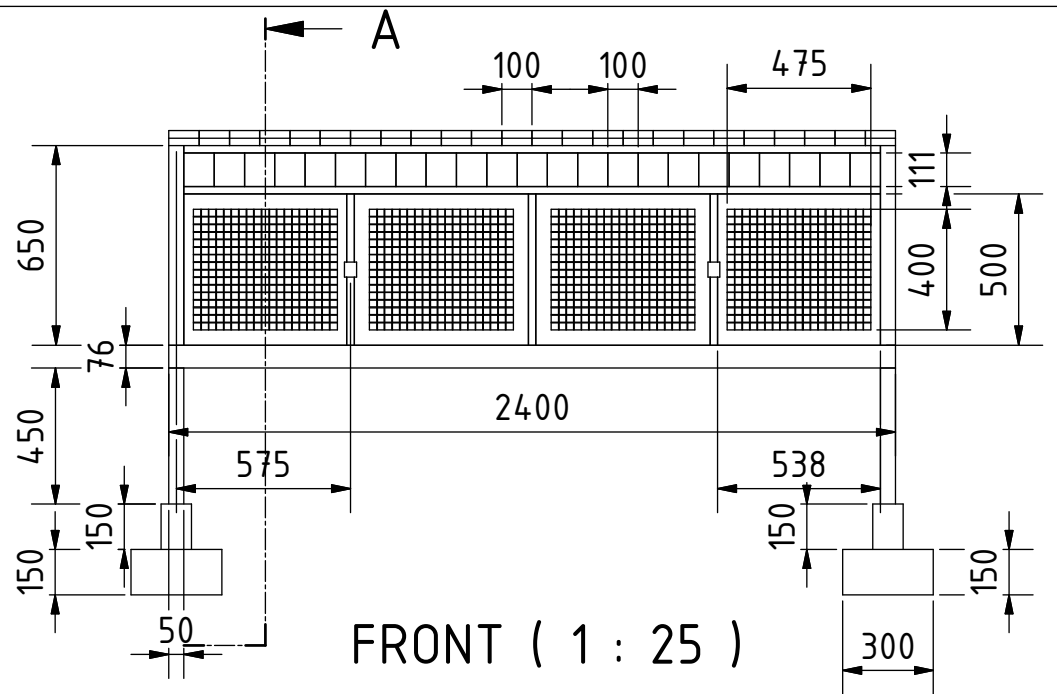
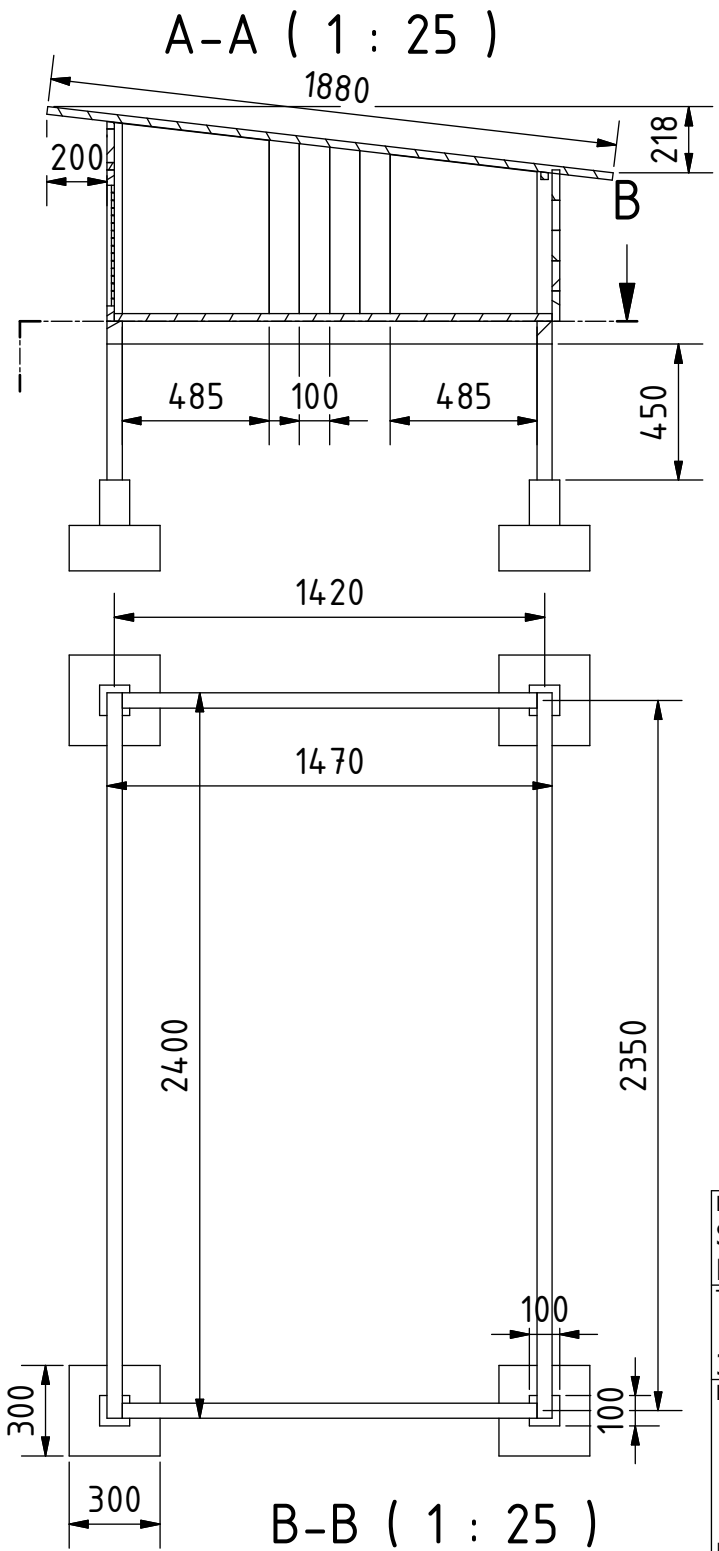

Note: all units are in mm

PROJEKT Sicherer und stabiler Kaninchenstall	ERSTELLT VON J. Zeron	GENEHMIGT VON A. Morillo	DATE 30/05/2021	VERSION 1.0
TEIL-NAME 3d-Ansichten	DATEI-NAME safe-and-sturdy-shelter.iam			TEIL-CODE A1
ENTWICKELT VON	UMGESTALTET VON 	DOK. TYP ASSEMBLY	WERKSTOFF	MENGE
UNIVERSITY OF GHANA	OHO e.V.	LIZENZ CC-BY-SA 4.0	SCALE 1:25	SEITE 2 / 24

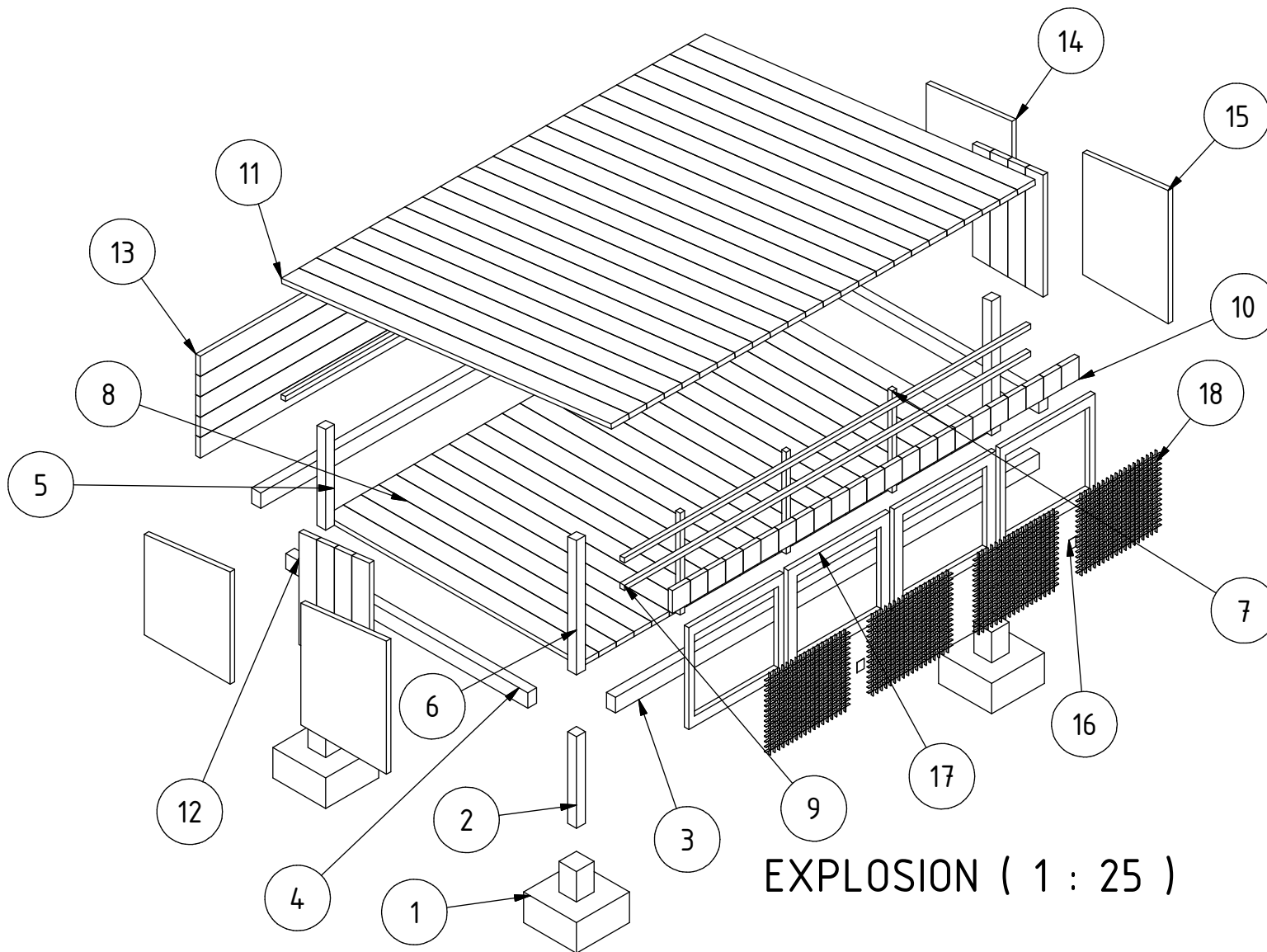

EXPLOSION (1 : 25)

PROJEKT Sicherer und stabiler Kaninchenstall		ERSTELLT VON J. Zeron		GENEHMIGT VON A. Morillo		DATE 30/05/2021		VERSION 1.0	
TEIL-NAME 3d-Explosionszeichnungen		DATEI-NAME safe-and-sturdy-shelter.ipn						TEIL-CODE A2	
ENTWICKELT VON UNIVERSITY OF GHANA		UMGESTALTET VON OHO e.V.		DOK. TYP ASSEMBLY		WERKSTOFF		MENGE -	
				LIZENZ CC-BY-SA 4.0		SCALE 1:25		SEITE 3 /24	

PARTS LIST

POS	QTY	TEIL NAME	DATEI-NAME	TEIL-TYP	SPEZIFIKATIONEN	SEITE
A1	-	3d-Ansichten	safe-and-sturdy-shelter.iam	-	-	1-2
A2	-	3d-Explosionszeichnungen	safe-and-sturdy-shelter.ipn	-	-	3
B1	-	Teileliste	uga_ sss_safe-and-sturdy-shelter	-	-	4
1	4	Stiftung	Foundation.ipt	Production	Strukturbeton	5
2	4	Spalte_1 - 2" x 2"	Column_1 - 2" x 2".ipt	Production	Teca-holz 2" x 2"	6
3	2	Balken_1 - 2" x 3"	Beam_1 - 2" x 3".ipt	Production	Teca-holz 2" x 3"	7
4	2	Balken_2 - 2" x 3"	Beam_2 - 2" x 3".ipt	Production	Teca-holz 2" x 3"	8
5	2	Spalte_2 - 2" x 2"	Column_2 - 2" x 2".ipt	Production	Teca-holz 2" x 2"	9
6	2	Spalte_3 - 2" x 2"	Column_3 - 2" x 2".ipt	Production	Teca-holz 2" x 2"	10
7	3	Spalte_4 - 1" x 1"	Column_4 - 1" x 1".ipt	Production	Teca-holz 1" x 1"	11
8	23	Bodendiele	Floor Plank.ipt	Production	Ofengetrocknetes holz 1"	12
9	3	Balken_3 - 1" x 1"	Beam_3 - 1" x 1".ipt	Production	Teca-holz 1" x 1"	13
10	23	Top Planke	Top Plank.ipt	Production	Ofengetrocknetes holz 1"	14
11	24	Dachplanke	Roof Plank.ipt	Production	Ofengetrocknetes holz 1"	15
12	2	Seitenplanke A	Side Plank A.ipt	Production	Ofengetrocknetes holz 1"	16
12.1	2	Seitenplanke B	Side Plank B.ipt	Production	Ofengetrocknetes holz 1"	17
12.2	2	Seitenplanke C	Side Plank C.ipt	Production	Ofengetrocknetes holz 1"	18
12.3	2	Seitenplanke D	Side Plank D.ipt	Production	Ofengetrocknetes holz 1"	19
13	5	Heckplanke	Rear Plank.ipt	Production	Ofengetrocknetes holz 1"	20
14	2	Seitenwand A	Side Wall A.ipt	Production	Sperrholz 1"	21
15	2	Seitenwand B	Side Wall B.ipt	Production	Sperrholz 1"	22
16	2	Fensterscharnier	Window Hinge.ipt	Buy	Messing 2"	-
17	4	Fensterrahmen	Window Frame.ipt	Production	Sperrholz 1"	23
18	4	Fenstergitter	Window Grid.ipt	Production	Huhnerdraht	24
19	-	Verbinden	-	Buy	Stahlnagel 1 1/2"	-

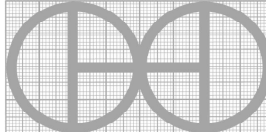
PROJEKT Sicherer und stabiler Kaninchenstall	ERSTELLT VON J. Zeron	GENEHMIGT VON A. Morillo	DATE 30/05/2021	VERSION 1.0
TEIL-NAME Teileliste	DATEI-NAME uga_ sss_safe-and-sturdy-shelter			TEIL-CODE B1
ENTWICKELT VON UNIVERSITY OF GHANA	UMGESTALTET VON  OHO e.V.	DOK. TYP ASSEMBLY	WERKSTOFF LIZENZ SCALE	MENGE - SEITE 4 /24
		CC-BY-SA 4.0		

C-C (1 : 5)

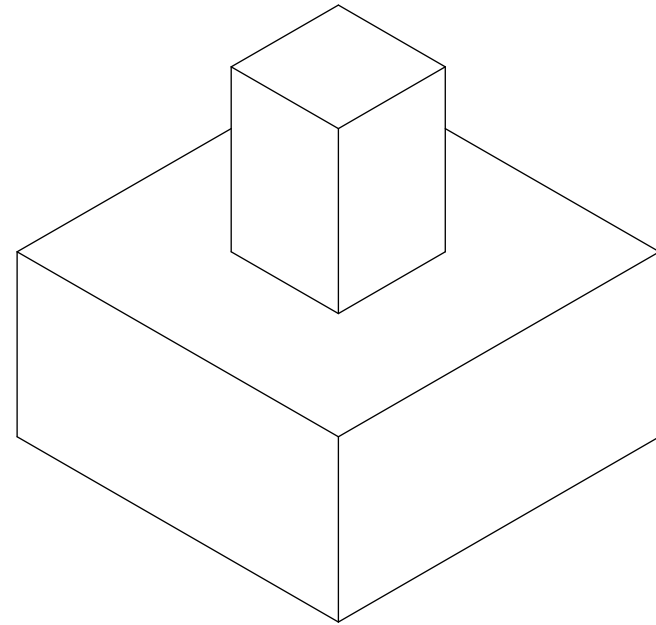
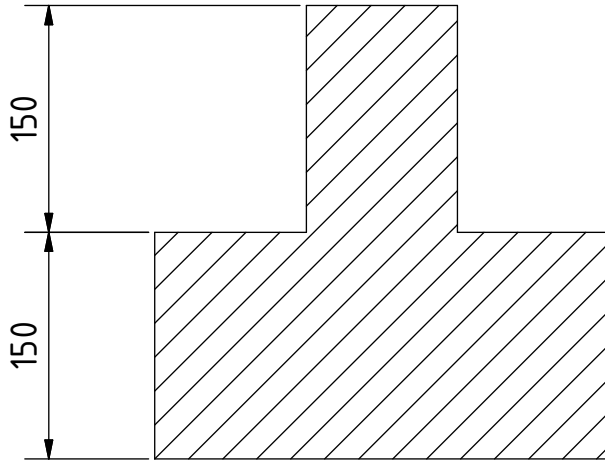

PLAN (1 : 5)

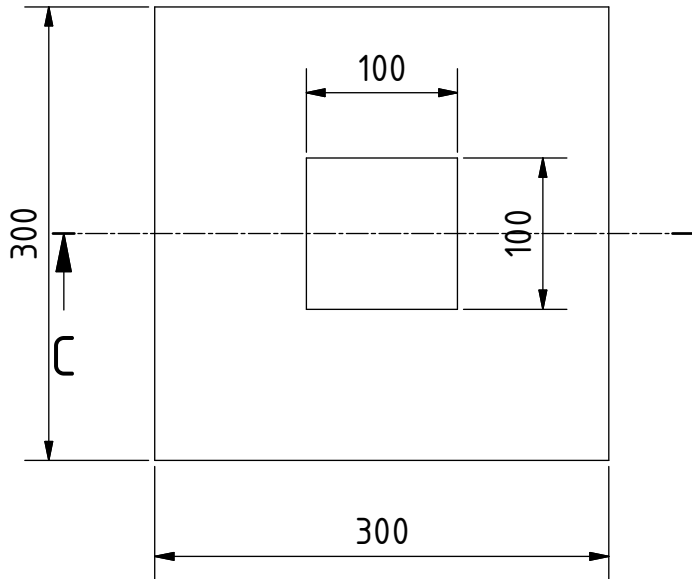

Note: all units are in mm

PROJEKT Sicherer und stabiler Kaninchenstall	ERSTELLT VON J. Zeron	GENEHMIGT VON A. Morillo	DATE 30/05/2021	VERSION 1.0
TEIL-NAME Stiftung	DATEI-NAME Foundation.ipt			TEIL-CODE 1
ENTWICKELT VON UNIVERSITY OF GHANA	UMGESTALTET VON OHO e.V.	DOK. TYP PART	WERKSTOFF Strukturbeton	MENGE 4
		LIZENZ CC-BY-SA 4.0	SCALE 1:5	SEITE 5 /24

ELEVATION (1 : 5)

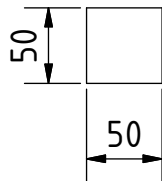
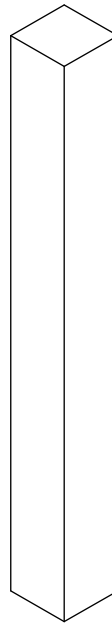
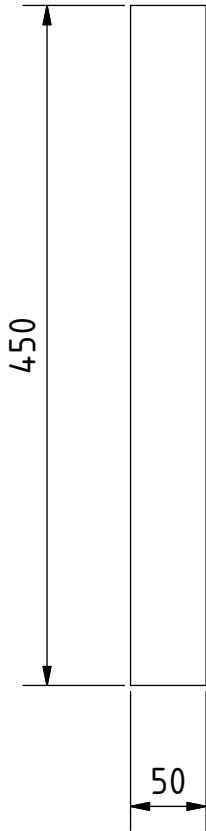

Note: all units are in mm

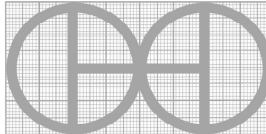
PROJEKT Sicherer und stabiler Kaninchenstall	ERSTELLT VON J. Zeron	GENEHMIGT VON A. Morillo	DATE 30/05/2021	VERSION 1.0
TEIL-NAME Spalte_1 - 2" x 2"	DATEI-NAME Column_1 - 2" x 2".ipt			TEIL-CODE 2
ENTWICKELT VON UNIVERSITY OF GHANA	UMGESTALTET VON  OHO e.V.	DOK. TYP PART LIZENZ CC-BY-SA 4.0	WERKSTOFF Teca-holz SCALE 1:5	MENGE 4 SEITE 6 /24

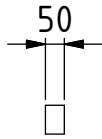

ELEVATION (1 : 20)

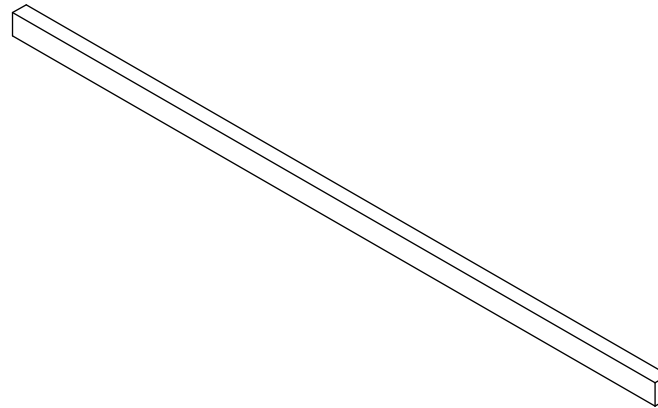
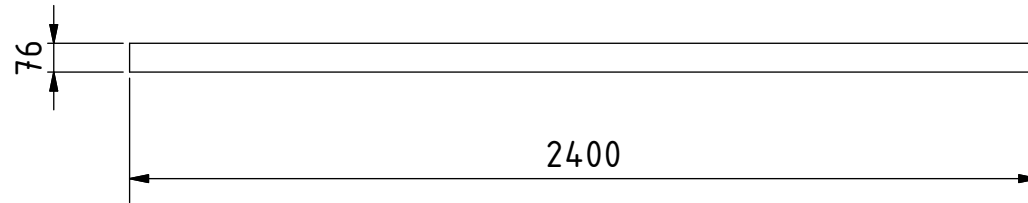

Note: all units are in mm

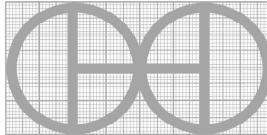
PROJEKT Sicherer und stabiler Kaninchenstall	ERSTELLT VON J. Zeron	GENEHMIGT VON A. Morillo	DATE 30/05/2021	VERSION 1.0
TEIL-NAME Balken_1 - 2" x 3"	DATEI-NAME Beam_1 - 2" x 3".ipt			TEIL-CODE 3
ENTWICKELT VON UNIVERSITY OF GHANA	UMGESTALTET VON  OHO e.V.	DOK. TYP PART LIZENZ CC-BY-SA 4.0	WERKSTOFF Teca-holz SCALE 1:20	MENGE 2 SEITE 7 / 24

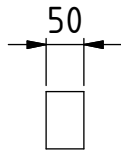

ELEVATION (1 : 10)

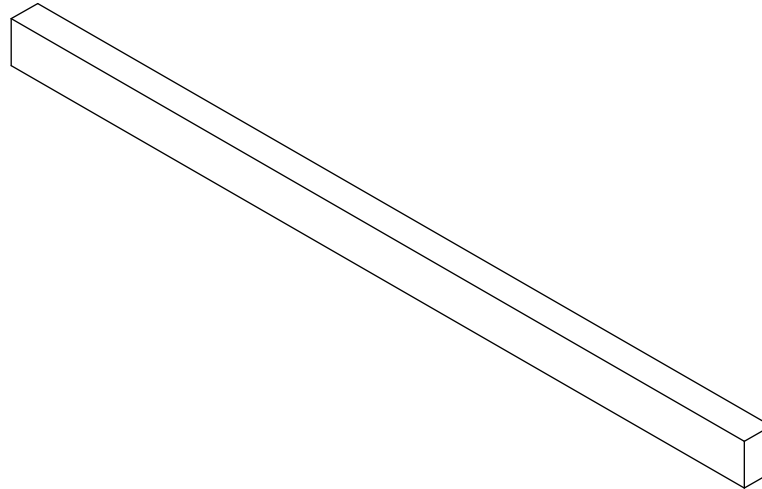
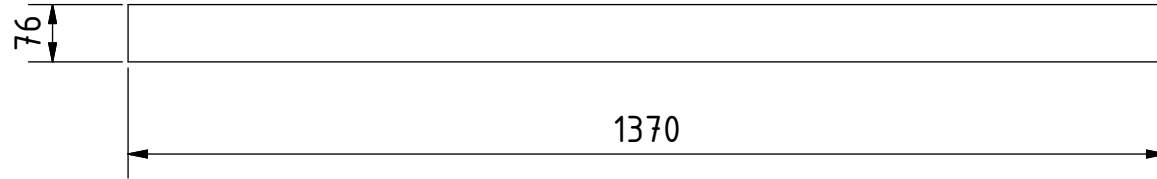

Note: all units are in mm

PROJEKT Sicherer und stabiler Kaninchenstall	ERSTELLT VON J. Zeron	GENEHMIGT VON A. Morillo	DATE 30/05/2021	VERSION 1.0
TEIL-NAME Balken_2 - 2" x 3"	DATEI-NAME Beam_2 - 2" x 3".ipt			TEIL-CODE 4
ENTWICKELT VON UNIVERSITY OF GHANA	UMGESTALTET VON OHO e.V.	DOK. TYP PART	WERKSTOFF Teca-holz	MENGE 2
		LIZENZ CC-BY-SA 4.0	SCALE 1:10	SEITE 8 /24

ELEVATION (1 : 5)

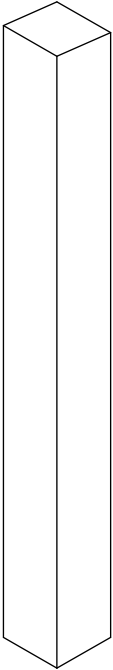
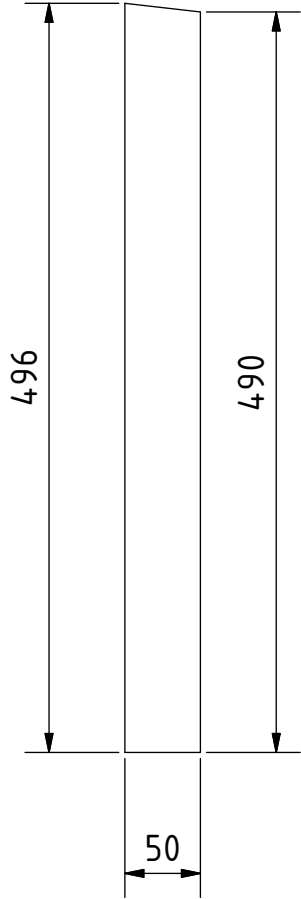

Note: all units are in mm

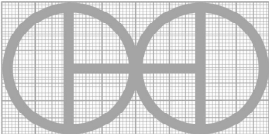
PROJEKT Sicherer und stabiler Kaninchenstall	ERSTELLT VON J. Zeron	GENEHMIGT VON A. Morillo	DATE 30/05/2021	VERSION 1.0
TEIL-NAME Spalte_2 - 2" x 2"	DATEI-NAME Column_2 - 2" x 2".ipt			TEIL-CODE 5
ENTWICKELT VON UNIVERSITY OF GHANA	UMGESTALTET VON  OHO e.V.	DOK. TYP PART	WERKSTOFF Teca-holz	MENGE 2
		LIZENZ CC-BY-SA 4.0	SCALE 1:5	SEITE 9 /24

ELEVATION (1 : 5)

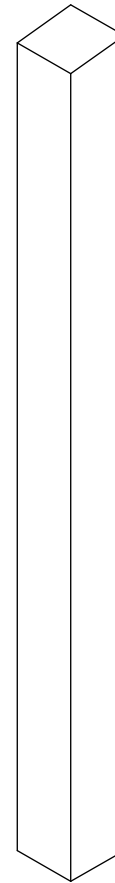
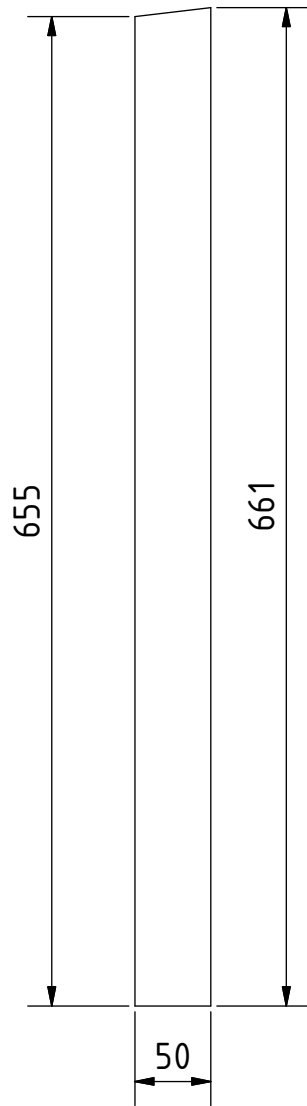

Note: all units are in mm

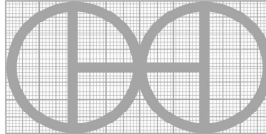
PROJEKT Sicherer und stabiler Kaninchenstall	ERSTELLT VON J. Zeron	GENEHMIGT VON A. Morillo	DATE 30/05/2021	VERSION 1.0
TEIL-NAME Spalte_3 - 2" x 2"	DATEI-NAME Column_3 - 2" x 2".ipt			TEIL-CODE 6
ENTWICKELT VON UNIVERSITY OF GHANA	UMGESTALTET VON  OHO e.V.	DOK. TYP PART	WERKSTOFF Teca-holz	MENGE 2
		LIZENZ CC-BY-SA 4.0	SCALE 1:5	SEITE 10 /24

ELEVATION (1 : 4)

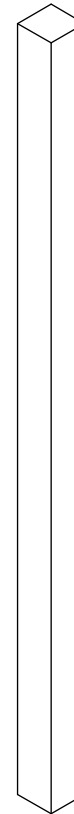
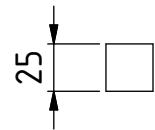
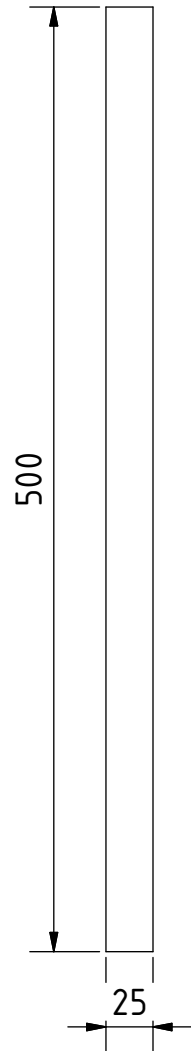

Note: all units are in mm

PROJEKT Sicherer und stabiler Kaninchenstall	ERSTELLT VON J. Zeron	GENEHMIGT VON A. Morillo	DATE 30/05/2021	VERSION 1.0
TEIL-NAME Spalte_4 - 1" x 1"	DATEI-NAME Column_4 - 1" x 1".ipt			TEIL-CODE 7
ENTWICKELT VON UNIVERSITY OF GHANA	UMGESTALTET VON OHO e.V.	DOK. TYP PART	WERKSTOFF Teca-holz	MENGE 3
		LIZENZ CC-BY-SA 4.0	SCALE 1:4	SEITE 11 /24

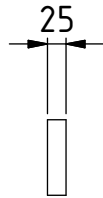

PLAN (1 : 10)

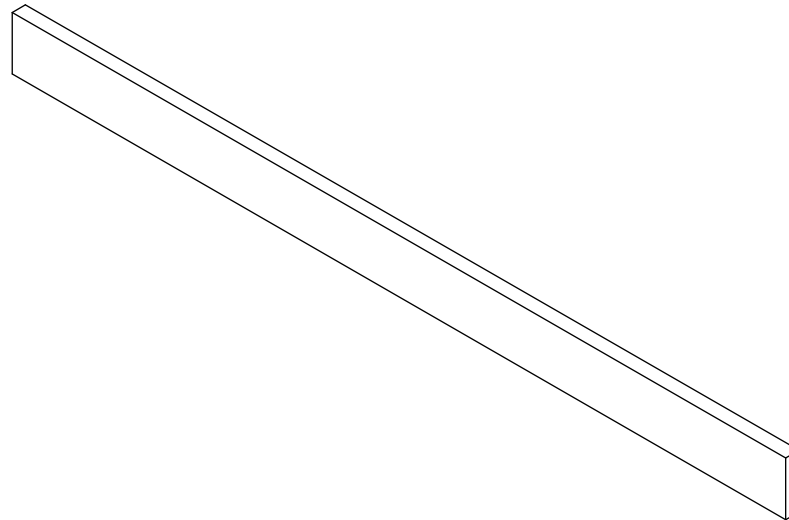
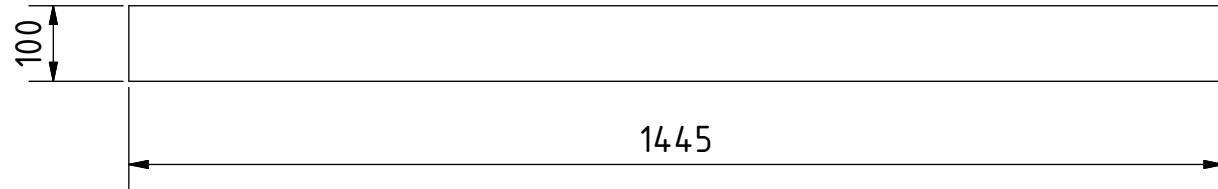

Note: all units are in mm

PROJEKT Sicherer und stabiler Kaninchenstall		ERSTELLT VON J. Zeron		GENEHMIGT VON A. Morillo		DATE 30/05/2021		VERSION 1.0	
TEIL-NAME Bodendiele			DATEI-NAME Floor Plank.ipt					TEIL-CODE 8	
ENTWICKELT VON UNIVERSITY OF GHANA			UMGESTALTET VON OHO e.V.		DOK. TYP PART		WERKSTOFF Ofengetrocknetes holz		MENGE 23
					LIZENZ CC-BY-SA 4.0		SCALE 1:10		SEITE 12 /24

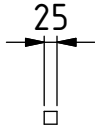

ELEVATION (1 :15)

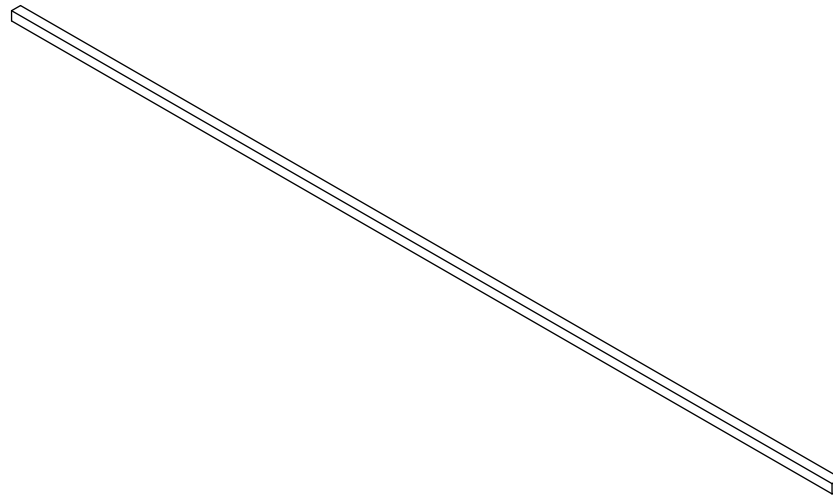
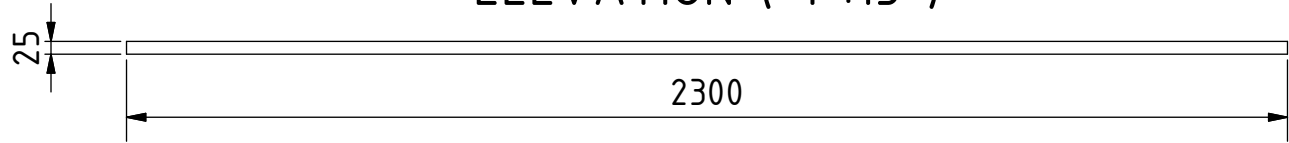

Note: all units are in mm

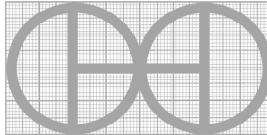
PROJEKT Sicherer und stabiler Kaninchenstall	ERSTELLT VON J. Zeron	GENEHMIGT VON A. Morillo	DATE 30/05/2021	VERSION 1.0
TEIL-NAME Balken_3 - 1" x 1"	DATEI-NAME Beam_3 - 1" x 1".ipt			TEIL-CODE 9
ENTWICKELT VON UNIVERSITY OF GHANA	UMGESTALTET VON  OHO e.V.	DOK. TYP PART LIZENZ CC-BY-SA 4.0	WERKSTOFF Teca-holz SCALE 1:15	MENGE 3 SEITE 13 /24

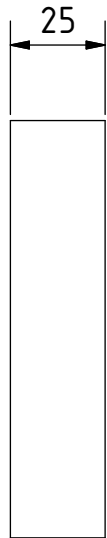

ELEVATION (1 : 2)

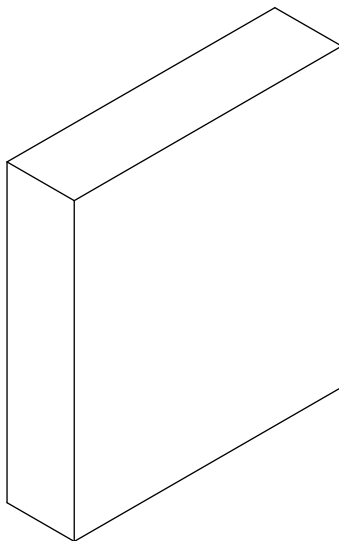
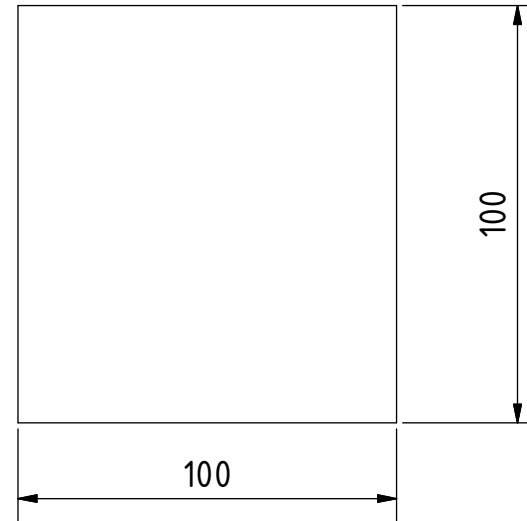

Note: all units are in mm

PROJEKT Sicherer und stabiler Kaninchenstall	ERSTELLT VON J. Zeron	GENEHMIGT VON A. Morillo	DATE 30/05/2021	VERSION 1.0
TEIL-NAME Top Planke	DATEI-NAME Top Plank.ipt			TEIL-CODE 10
ENTWICKELT VON UNIVERSITY OF GHANA	UMGESTALTET VON OHO e.V.	DOK. TYP PART	WERKSTOFF Ofengetrocknetes holz	MENGE 23
		LIZENZ CC-BY-SA 4.0	SCALE 1:2	SEITE 14 /24

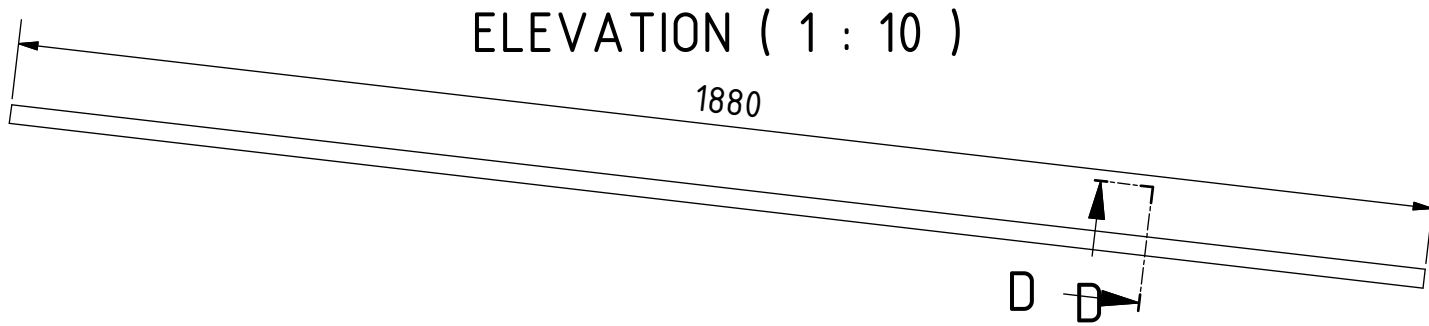

D-D (1 : 10)

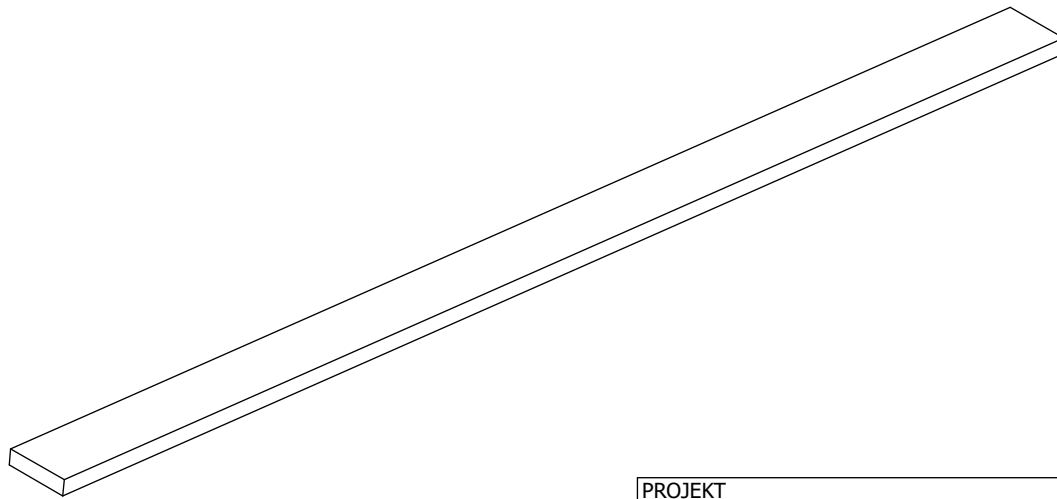
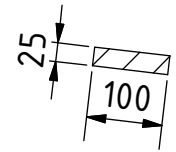

Note: all units are in mm

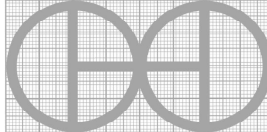
PROJEKT Sicherer und stabiler Kaninchenstall	ERSTELLT VON J. Zeron	GENEHMIGT VON A. Morillo	DATE 30/05/2021	VERSION 1.0
TEIL-NAME Dachplanke	DATEI-NAME Roof Plank.ipt			TEIL-CODE 11
ENTWICKELT VON UNIVERSITY OF GHANA	UMGESTALTET VON  OHO e.V.	DOK. TYP PART LIZENZ CC-BY-SA 4.0	WERKSTOFF Ofengetrocknetes holz	MENGE 24 SEITE 15 /24
		SCALE 1:10		

ELEVATION (1 : 5)

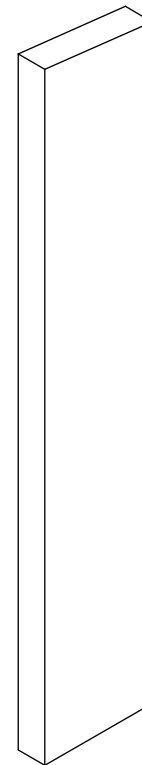
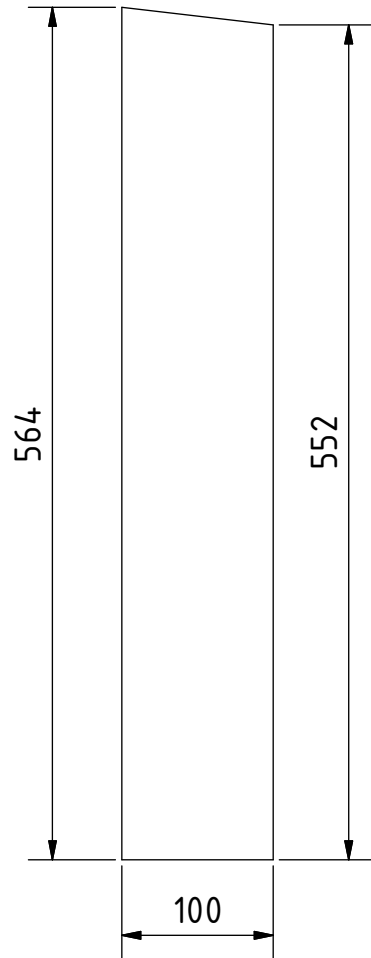

Note: all units are in mm

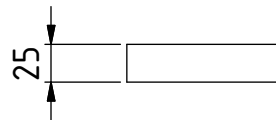

PROJEKT Sicherer und stabiler Kaninchenstall	ERSTELLT VON J. Zeron	GENEHMIGT VON A. Morillo	DATE 30/05/2021	VERSION 1.0
TEIL-NAME Seitenplanke A	DATEI-NAME Side Plank A.ipt			TEIL-CODE 12
ENTWICKELT VON UNIVERSITY OF GHANA	UMGESTALTET VON OHO e.V.	DOK. TYP PART	WERKSTOFF Ofengetrocknetes holz	MENGE 2
		LIZENZ CC-BY-SA 4.0	SCALE	SEITE 16 /24

ELEVATION (1 : 5)

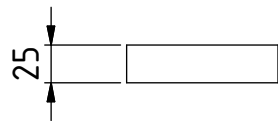
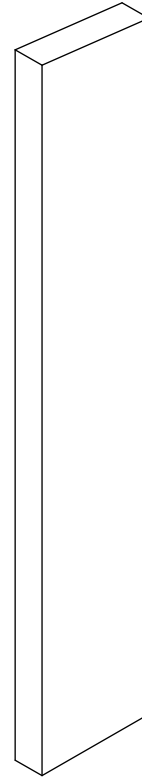
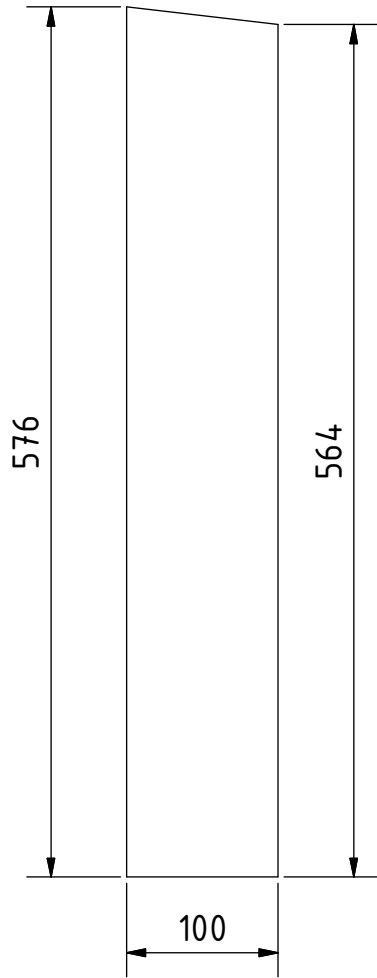

Note: all units are in mm

PROJEKT Sicherer und stabiler Kaninchenstall	ERSTELLT VON J. Zeron	GENEHMIGT VON A. Morillo	DATE 30/05/2021	VERSION 1.0
TEIL-NAME Seitenplanke B	DATEI-NAME Side Plank B.ipt			TEIL-CODE 12.1
ENTWICKELT VON UNIVERSITY OF GHANA	UMGESTALTET VON OHO e.V.	DOK. TYP PART	WERKSTOFF Ofengetrocknetes holz2	MENGE 12.1
		LIZENZ CC-BY-SA 4.0	SCALE 1:5	SEITE 17 /24

ELEVATION (1 : 5)

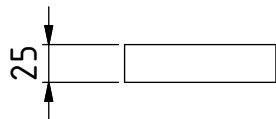
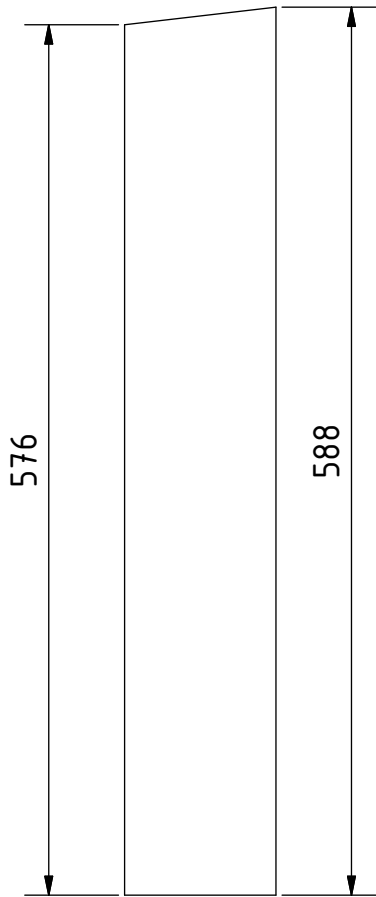

Note: all units are in mm

PROJEKT Sicherer und stabiler Kaninchenstall	ERSTELLT VON J. Zeron	GENEHMIGT VON A. Morillo	DATE 30/05/2021	VERSION 1.0
TEIL-NAME Seitenplanke C	DATEI-NAME Side Plank C.ipt			TEIL-CODE 12.2
ENTWICKELT VON UNIVERSITY OF GHANA	UMGESTALTET VON OHO e.V.	DOK. TYP PART	WERKSTOFF Ofengetrocknetes holz2	MENGE 18 /24
		LIZENZ CC-BY-SA 4.0	SCALE 1:5	SEITE 18 /24

ELEVATION (1 : 5)

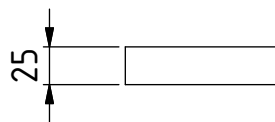
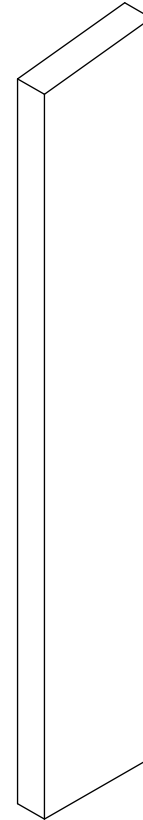
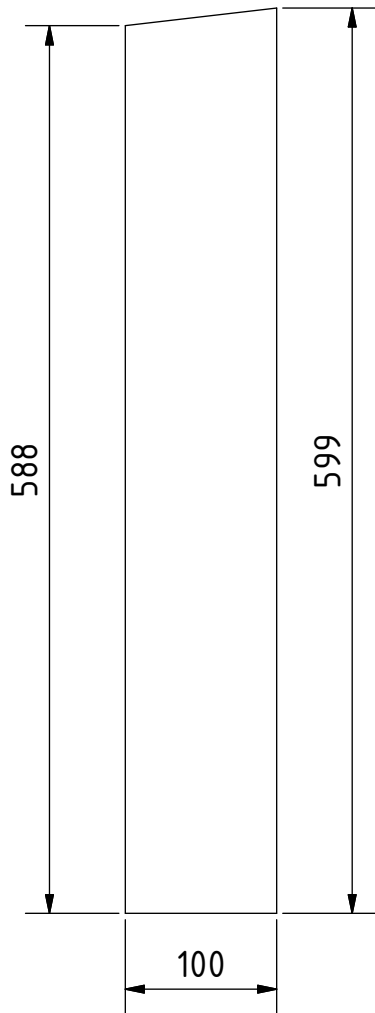

Note: all units are in mm

PROJEKT Sicherer und stabiler Kaninchenstall	ERSTELLT VON J. Zeron	GENEHMIGT VON A. Morillo	DATE 30/05/2021	VERSION 1.0
TEIL-NAME Seitenplanke D	DATEI-NAME Side Plank D.ipt			TEIL-CODE 12.3
ENTWICKELT VON UNIVERSITY OF GHANA	UMGESTALTET VON OHO e.V.	DOK. TYP PART	WERKSTOFF Ofengetrocknetes holz2	MENGE 2
		LIZENZ CC-BY-SA 4.0	SCALE 1:5	SEITE 19 /24

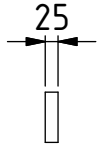

ELEVATION (1 :15)

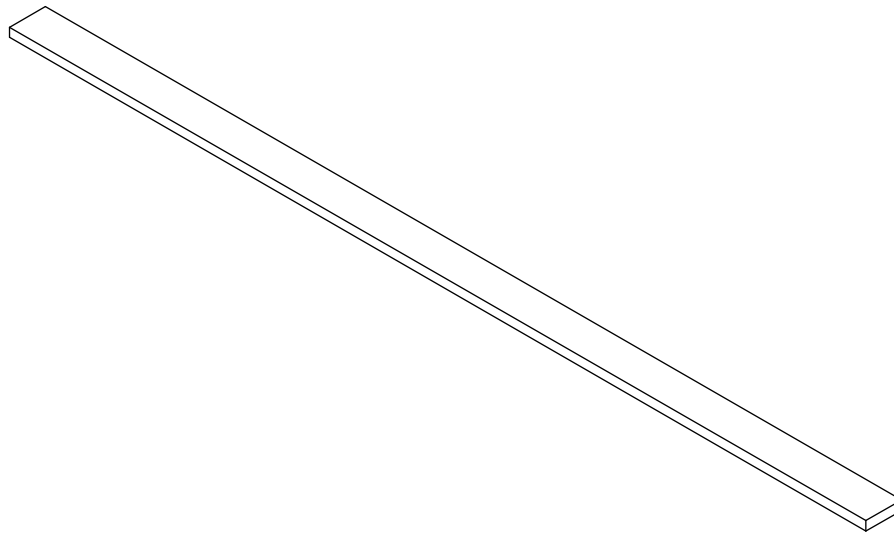
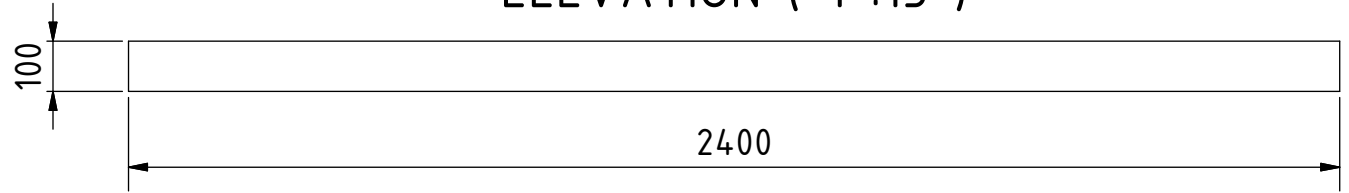

Note: all units are in mm

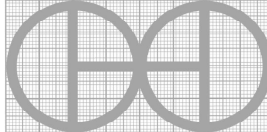
PROJEKT Sicherer und stabiler Kaninchenstall	ERSTELLT VON J. Zeron	GENEHMIGT VON A. Morillo	DATE 30/05/2021	VERSION 1.0
TEIL-NAME Heckplanke	DATEI-NAME Rear Plank.ipt			TEIL-CODE 13
ENTWICKELT VON UNIVERSITY OF GHANA	UMGESTALTET VON  OHO e.V.	DOK. TYP PART	WERKSTOFF Ofengetrocknetes holz5	MENGE 5
		LIZENZ CC-BY-SA 4.0	SCALE 1:15	SEITE 20 /24

ELEVATION (1 : 10)

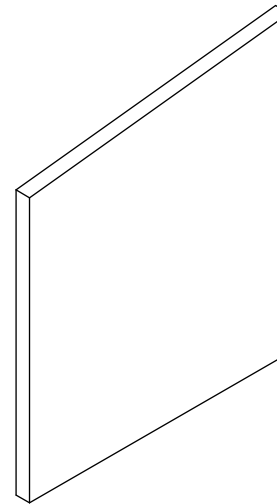
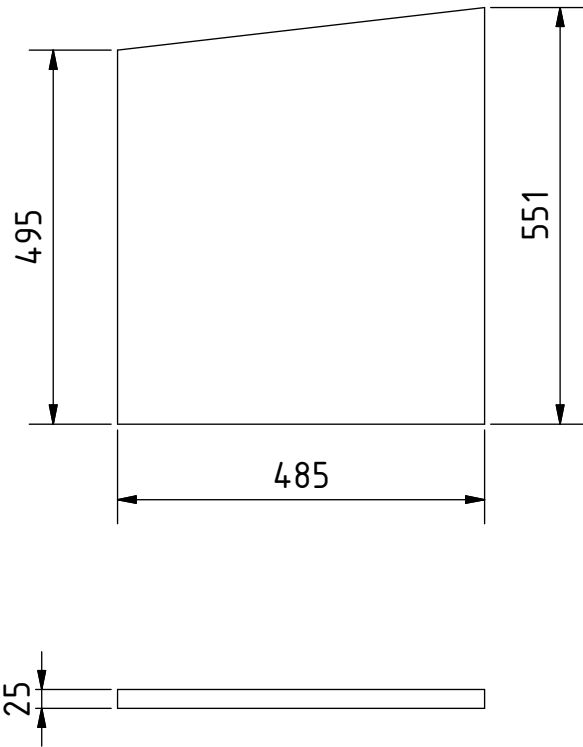

Note: all units are in mm

PROJEKT Sicherer und stabiler Kaninchenstall	ERSTELLT VON J. Zeron	GENEHMIGT VON A. Morillo	DATE 30/05/2021	VERSION 1.0
TEIL-NAME Seitenwand A	DATEI-NAME Side Wall A.ipt			TEIL-CODE 14
ENTWICKELT VON UNIVERSITY OF GHANA	UMGESTALTET VON OHO e.V.	DOK. TYP PART	WERKSTOFF Sperrholz	MENGE 2
		LIZENZ CC-BY-SA 4.0	SCALE 1:10	SEITE 21 /24

ELEVATION (1 : 10)

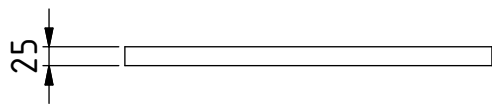
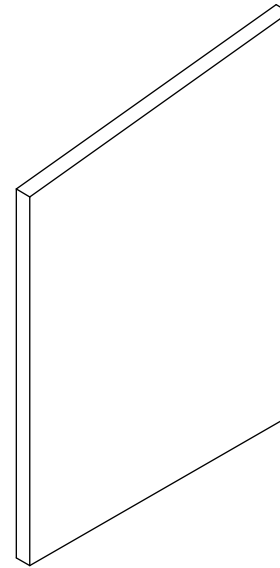
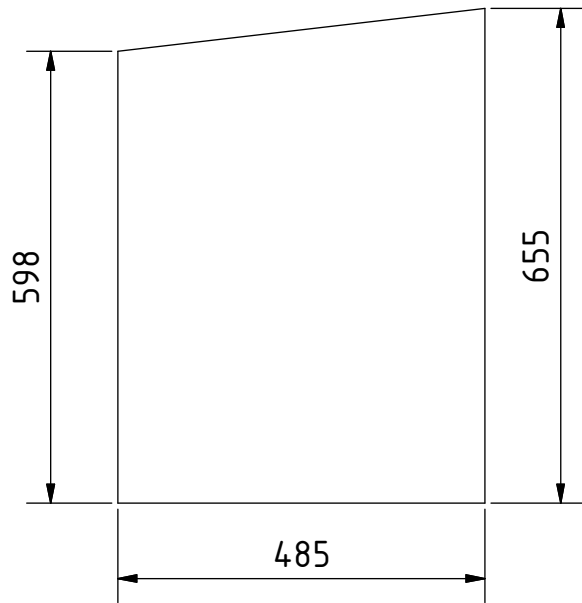

Note: all units are in mm

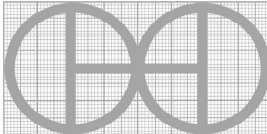
PROJEKT Sicherer und stabiler Kaninchenstall	ERSTELLT VON J. Zeron	GENEHMIGT VON A. Morillo	DATE 30/05/2021	VERSION 1.0
TEIL-NAME Seitenwand B	DATEI-NAME Side Wall B.ipt			TEIL-CODE 15
ENTWICKELT VON UNIVERSITY OF GHANA	UMGESTALTET VON  OHO e.V.	DOK. TYP PART	WERKSTOFF Sperrholz	MENGE 2
		LIZENZ CC-BY-SA 4.0	SCALE 1:10	SEITE 22 /24

ELEVATION (1 : 10)

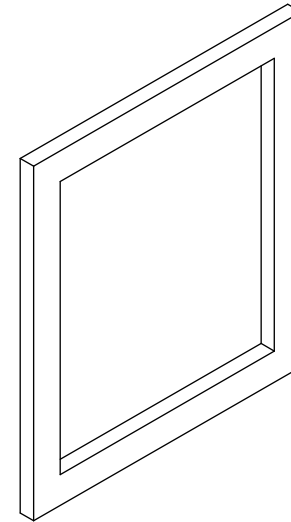
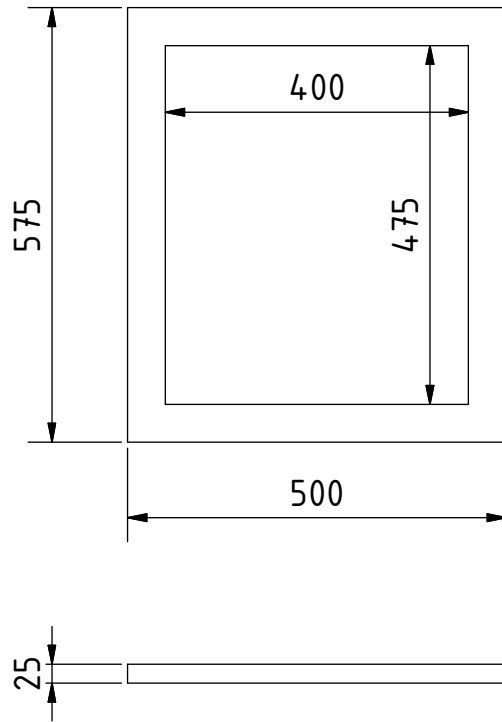

Note: all units are in mm

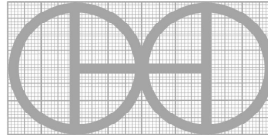
PROJEKT Sicherer und stabiler Kaninchenstall	ERSTELLT VON J. Zeron	GENEHMIGT VON A. Morillo	DATE 30/05/2021	VERSION 1.0
TEIL-NAME Fensterrahmen	DATEI-NAME Window Frame.ipt			TEIL-CODE 17
ENTWICKELT VON	UMGESTALTET VON  OHO e.V.	DOK. TYP PART	WERKSTOFF Sperrholz	MENGE 4
UNIVERSITY OF GHANA		LIZENZ CC-BY-SA 4.0	SCALE 1:10	SEITE 23 /24

ELEVATION (1 : 10)

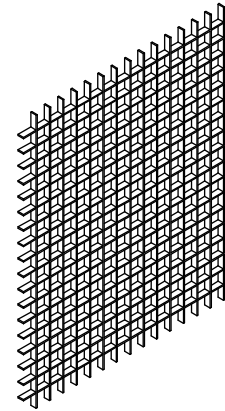
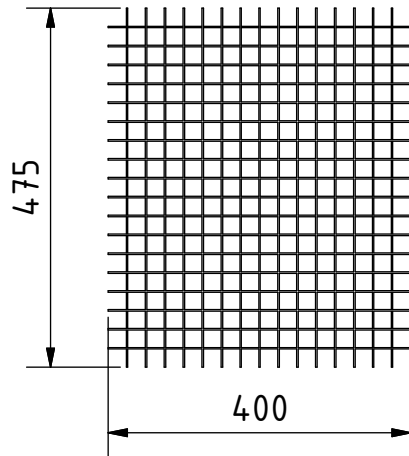

Note: all units are in mm

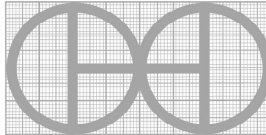
PROJEKT Sicherer und stabiler Kaninchenstall	ERSTELLT VON J. Zeron	GENEHMIGT VON A. Morillo	DATE 30/05/2021	VERSION 1.0
TEIL-NAME Fenstergitter	DATEI-NAME Window Grid.ipt			TEIL-CODE 18
ENTWICKELT VON UNIVERSITY OF GHANA	UMGESTALTET VON  OHO e.V.	DOK. TYP PART	WERKSTOFF Huhnerdraht	MENGE 4
		LIZENZ CC-BY-SA 4.0	SCALE 1:10	SEITE 24 /24