

A (1 : 5)

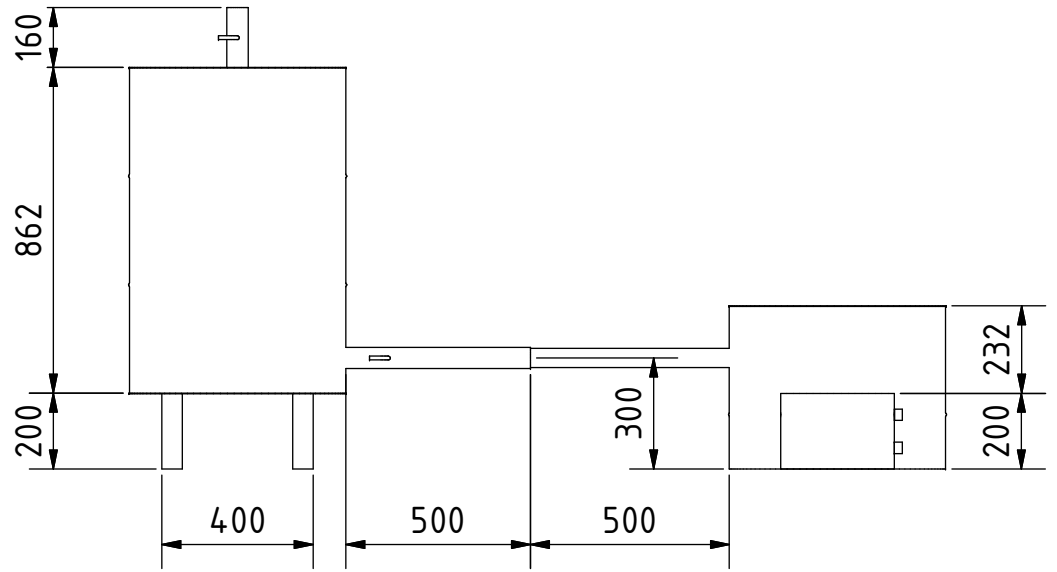

A-A (1 : 20)

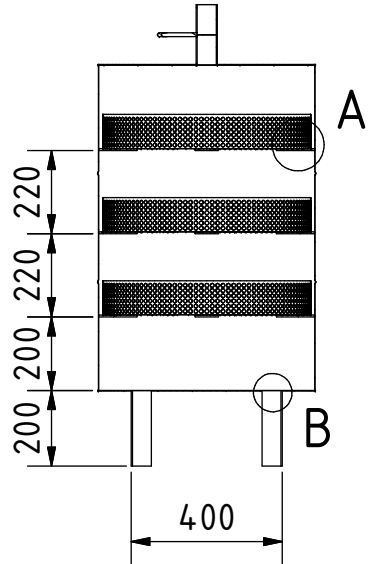
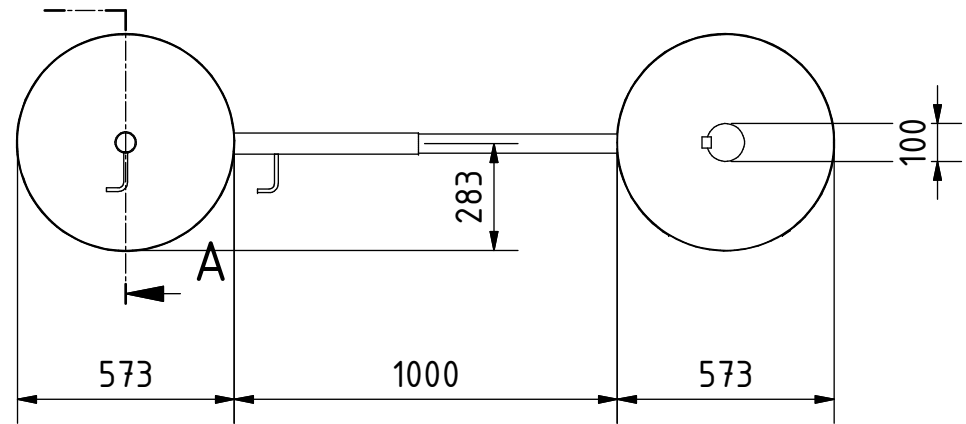
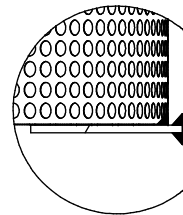

A (1 : 5)

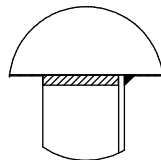

Hinweis: Alle einheiten in mm.

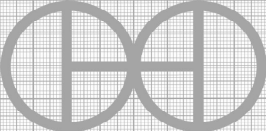
| | | | | |
|--|--|-----------------------------|-------------------------------------|---|
| PROJEKT Trommel Fischtrockner Räucherer | ERSTELLT VON J. Zeron | GENEHMIGT VON A. Morillo | DATE 08/06/2021 | VERSION 1.0 |
| TEIL-NAME 3D-Ansichten | DATEI-NAME manual-fuel-briquette-press.iam | | | TEIL-CODE A1 |
| ENTWICKELT VON INTERNATIONAL LABOUR OFFICE | UMGESTALTET VON  OHO e.V. | DOK. TYP ASSEMBLY | WERKSTOFF LIZENZ CC-BY-SA 4.0 | MENGE SCALE 1:20 SEITE 1 / 17 |

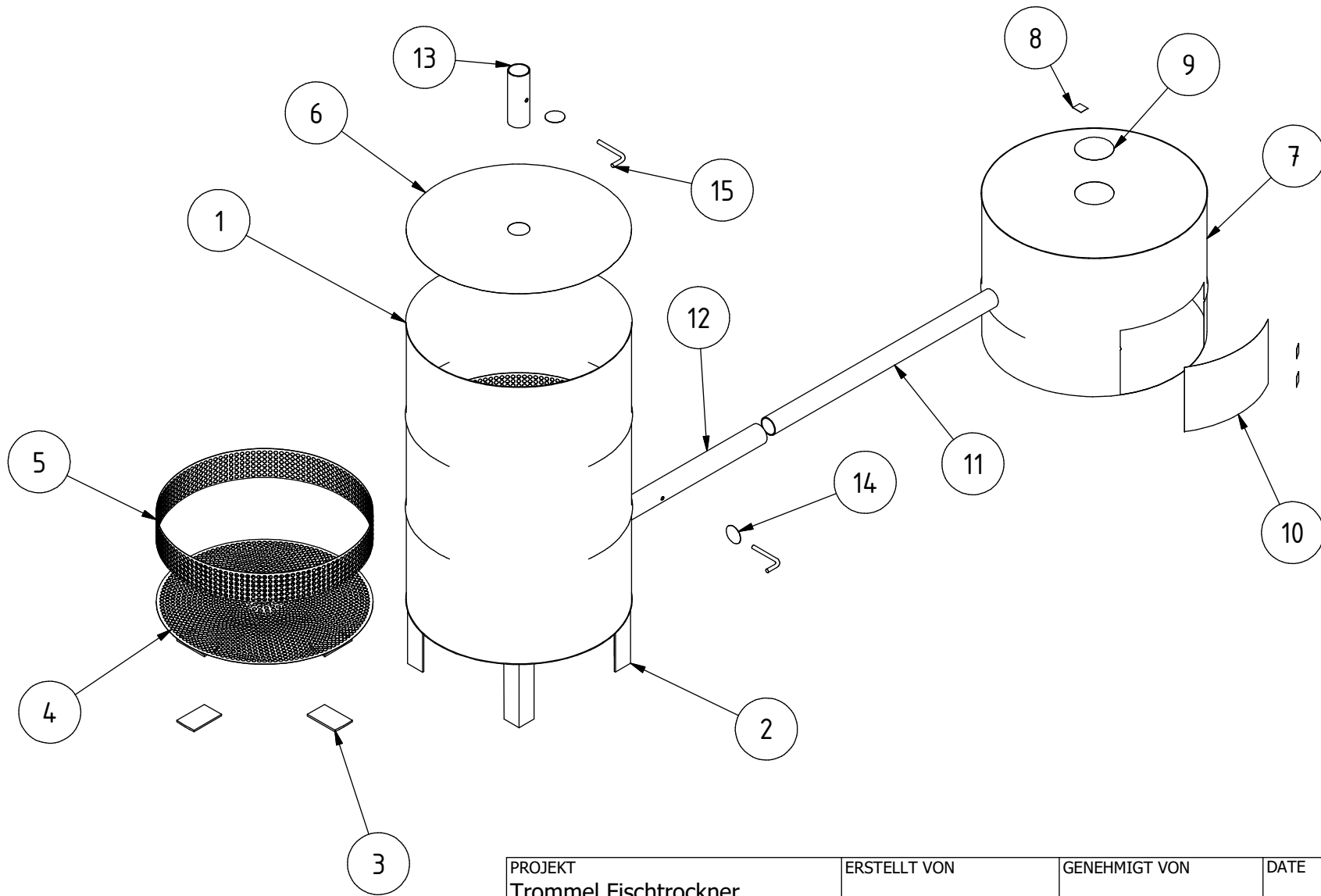

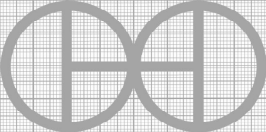
| | | | | |
|--|--|-----------------------------|-------------------------------------|--|
| PROJEKT Trommel Fischtrockner Räucherer | ERSTELLT VON J. Zeron | GENEHMIGT VON A. Morillo | DATE 08/06/2021 | VERSION 1.0 |
| TEIL-NAME 3D-Explosionszeichnungen | DATEI-NAME ilo_dfds_dum-fish-dryer-smoker.ipn | | | TEIL-CODE A2 |
| ENTWICKELT VON INTERNATIONAL LABOUR OFFICE | UMGESTALTET VON  OHO e.V. | DOK. TYP ASSEMBLY | WERKSTOFF LIZENZ CC-BY-SA 4.0 | MENGE - SCALE 1:15 SEITE 2 / 17 |

PARTS LIST

| POS | QTY | TEIL NAME | DATEI-NAME | TEIL-TYP | SPEZIFIKATIONEN | SEITE |
|-----|-----|--------------------------|------------------------------------|------------|--|-------|
| A1 | - | 3D-Ansichten | manual-fuel-briquette-press.iam | ASSEMBLY | - | 1 |
| A2 | - | 3D-Explosionszeichnungen | ilo_dfds_dum-fish-dryer-smoker.ipn | ASSEMBLY | - | 2 |
| B1 | - | Teileliste | ilo_dfds_dum-fish-dryer-smoker.csv | - | - | 3 |
| 1 | 1 | Rauchtrommel | Smoker drum.ipt | Production | Gewalzter Stahl | 4 |
| 2 | 4 | Fuß | Foot.ipt | Production | Winkel aus Kohlenstoffstahl 50x50x4 mm Güteklasse A42 L=20 cm | 5 |
| 3 | 12 | Tablettboden | Tray base.ipt | Production | 2" Kohlenstoffstahlplatte PS-25 | 6 |
| 4 | 3 | Tablett A | Tray A.ipt | Production | Perforiertes Metall, Dicke 1-2 mm | 7 |
| 5 | 3 | Tablett B | Tray B.ipt | Production | Perforiertes Metall, Dicke 1-2 mm | 8 |
| 6 | 1 | Deckel | Lid.ipt | Production | Trommel aus Altmetall | 9 |
| 7 | 1 | Feuertrommel | Fire drum.ipt | Production | Trommel aus Altmetall | 10 |
| 8 | 3 | Scharnier | - | Buy | Messing 1", genietet | - |
| 9 | 1 | Obere Düse | Upper nozzle.ipt | Production | Schrottfässer aus Metall | 11 |
| 10 | 1 | Seitlicher Einlass | Side entrance.ipt | Production | Schrottfässer aus Metall | 12 |
| 11 | 1 | Rohr A | Tube A.ipt | Production | 2" Schwarzes Eisen L=80cm | 13 |
| 12 | 1 | Rohr B | Tube B.ipt | Production | 2 1/4" schwarzes Eisen L=50cm | 14 |
| 13 | 1 | Rohr C | Tube C.ipt | Production | 2 1/4" Schwarzes Eisen L=16cm | 15 |
| 14 | 2 | Düse | Nozzle.ipt | Production | Bleche | 16 |
| 15 | 2 | Bar | Bar.ipt | Production | 3/8" Flacheisen | 17 |

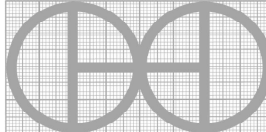
| | | | | |
|--|--|-----------------------------|--------------------|-----------------|
| PROJEKT Trommel Fischtrockner Räucherer | ERSTELLT VON J. Zeron | GENEHMIGT VON A. Morillo | DATE 08/06/2021 | VERSION 1.0 |
| TEIL-NAME Teileliste | DATEI-NAME ilo_dfds_dum-fish-dryer-smoker.csv | TEIL-CODE B1 | | |
| ENTWICKELT VON INTERNATIONAL LABOUR OFFICE | UMGESTALTET VON  OHO e.V. | DOK. TYP PART LIST | WERKSTOFF | MENGE - |
| | | LIZENZ CC-BY-SA 4.0 | SCALE | SEITE 3 / 17 |

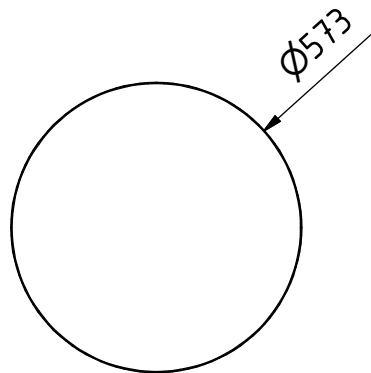
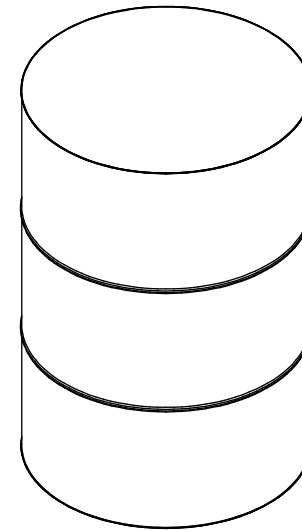
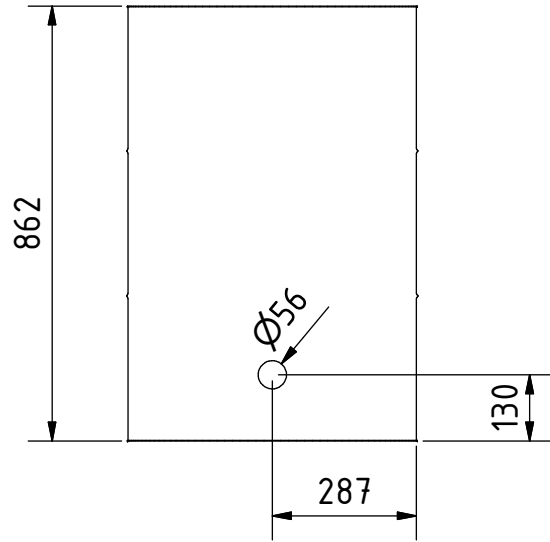

Hinweis: Alle einheiten in mm.

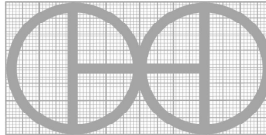
| | | | | |
|--|--|-----------------------------|------------------------------|-----------------|
| PROJEKT Trommel Fischtrockner Räucherer | ERSTELLT VON J. Zeron | GENEHMIGT VON A. Morillo | DATE 08/06/2021 | VERSION 1.0 |
| TEIL-NAME Rauchtrommel | DATEI-NAME Smoker drum.ipt | | | TEIL-CODE 1 |
| ENTWICKELT VON INTERNATIONAL LABOUR OFFICE | UMGESTALTET VON  OHO e.V. | DOK. TYP PART | WERKSTOFF Gewalzter Stahl | MENGE 1 |
| | | LIZENZ CC-BY-SA 4.0 | SCALE 1:13 | SEITE 4 / 17 |

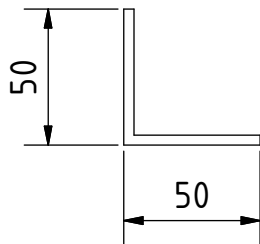
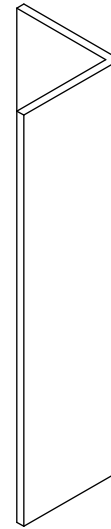
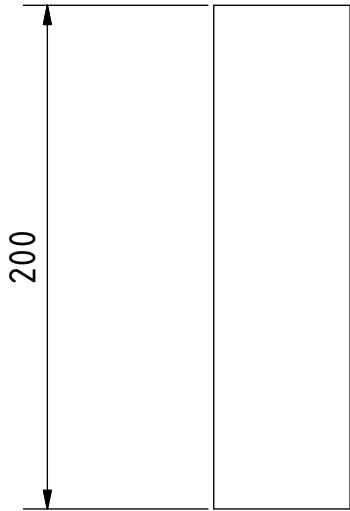

Hinweis: Alle einheiten in mm.

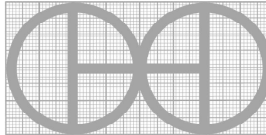
| | | | | |
|--|--|-----------------------------|-------------------------------|-----------------|
| PROJEKT Trommel Fischtrockner Räucherer | ERSTELLT VON J. Zeron | GENEHMIGT VON A. Morillo | DATE 08/06/2021 | VERSION 1.0 |
| TEIL-NAME Fuß | DATEI-NAME Foot.ipt | | | TEIL-CODE 2 |
| ENTWICKELT VON INTERNATIONAL LABOUR OFFICE | UMGESTALTET VON  OHO e.V. | DOK. TYP PART | WERKSTOFF Kohlenstoffstahl | MENGE 4 |
| | | LIZENZ CC-BY-SA 4.0 | SCALE 1:3 | SEITE 5 / 17 |

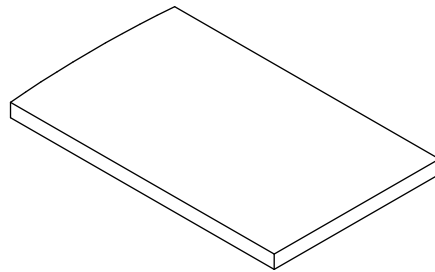
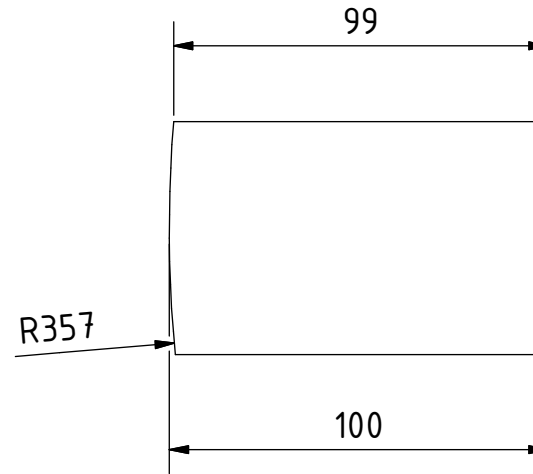
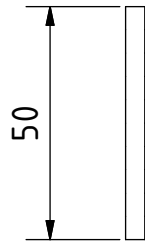

Hinweis: Alle einheiten in mm.

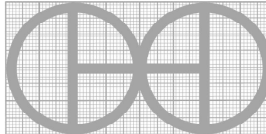
| | | | | |
|--|--|-----------------------------|-------------------------------|-----------------|
| PROJEKT Trommel Fischtrockner Räucherer | ERSTELLT VON J. Zeron | GENEHMIGT VON A. Morillo | DATE 08/06/2021 | VERSION 1.0 |
| TEIL-NAME Tablettboden | DATEI-NAME Tray base.ipt | | | TEIL-CODE 3 |
| ENTWICKELT VON INTERNATIONAL LABOUR OFFICE | UMGESTALTET VON  OHO e.V. | DOK. TYP PART | WERKSTOFF Kohlenstoffstahl | MENGE 12 |
| | | LIZENZ CC-BY-SA 4.0 | SCALE 1:2 | SEITE 6 / 17 |

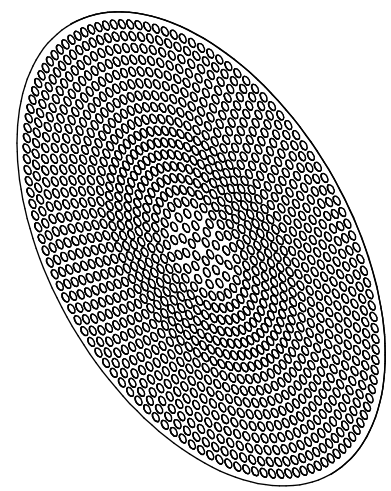
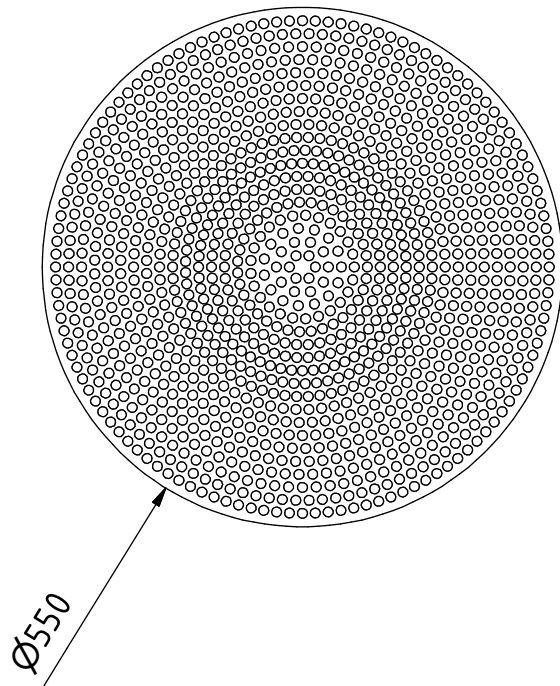

Hinweis: Alle einheiten in mm.

| | | | | |
|--|-----------------------------|-----------------------------|----------------------------------|-----------------|
| PROJEKT Trommel Fischtrockner Räucherer | ERSTELLT VON J. Zeron | GENEHMIGT VON A. Morillo | DATE 08/06/2021 | VERSION 1.0 |
| TEIL-NAME Tablett A | DATEI-NAME Tray A.ipt | | | TEIL-CODE 4 |
| ENTWICKELT VON INTERNATIONAL LABOUR OFFICE | UMGESTALTET VON OHO e.V. | DOK. TYP PART | WERKSTOFF Perforiertes Metall | MENGE 3 |
| | | LIZENZ CC-BY-SA 4.0 | SCALE 1:8 | SEITE 7 / 17 |

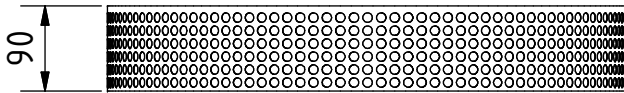
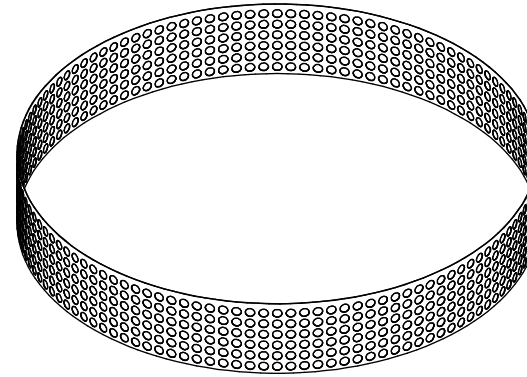
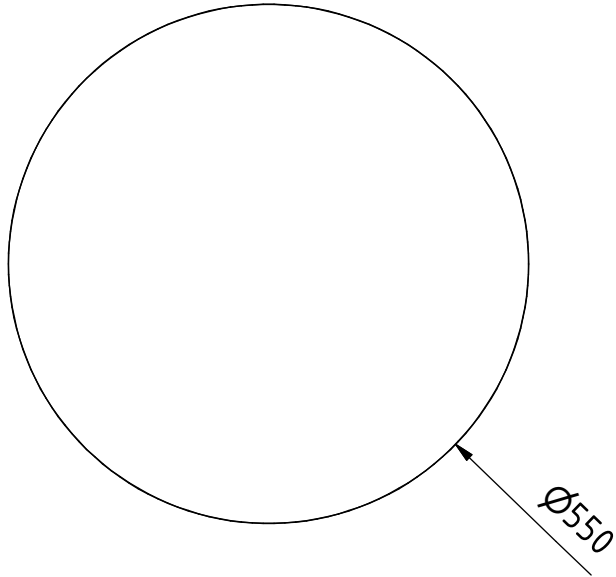

Hinweis: Alle einheiten in mm.

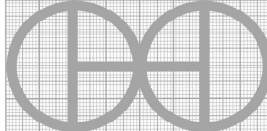
| | | | | |
|--|--|--|--|-------------------------------|
| PROJEKT Trommel Fischtrockner Räucherer | ERSTELLT VON J. Zeron | GENEHMIGT VON A. Morillo | DATE 08/06/2021 | VERSION 1.0 |
| TEIL-NAME Tablett B | DATEI-NAME Tray B.ipt | | | TEIL-CODE 5 |
| ENTWICKELT VON INTERNATIONAL LABOUR OFFICE | UMGESTALTET VON  OHO e.V. | DOK. TYP PART LIZENZ CC-BY-SA 4.0 | WERKSTOFF Perforiertes Metall SCALE 1:8 | MENGE 3 SEITE 8 / 17 |

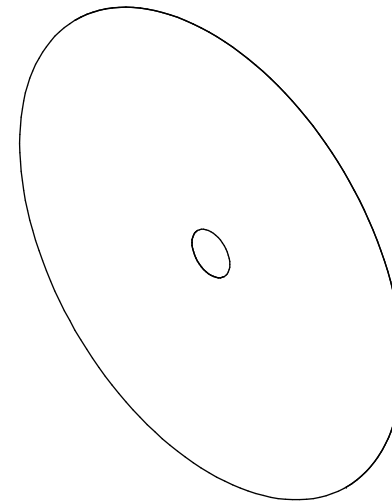
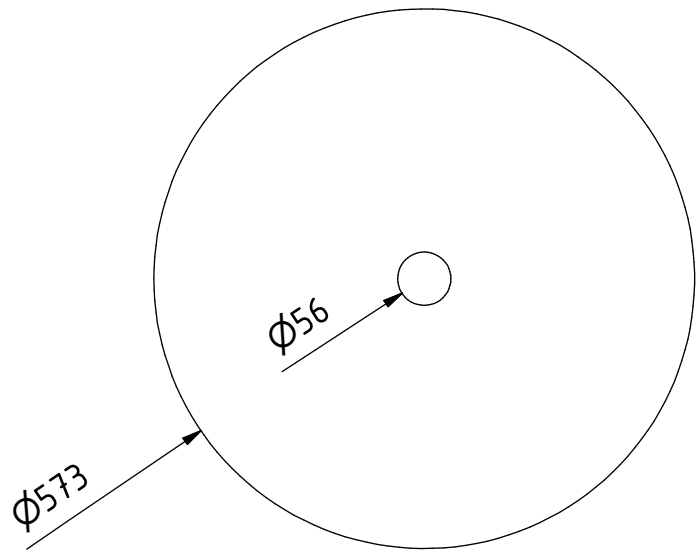

Hinweis: Alle einheiten in mm.

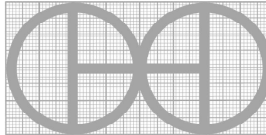
| | | | | |
|--|--|-----------------------------|--|-----------------|
| PROJEKT Trommel Fischtrockner Räucherer | ERSTELLT VON J. Zeron | GENEHMIGT VON A. Morillo | DATE 08/06/2021 | VERSION 1.0 |
| TEIL-NAME Deckel | DATEI-NAME Lid.ipt | | | TEIL-CODE 6 |
| ENTWICKELT VON INTERNATIONAL LABOUR OFFICE | UMGESTALTET VON  OHO e.V. | DOK. TYP PART | WERKSTOFF Schrottfässer aus Metall | MENGE 1 |
| | | LIZENZ CC-BY-SA 4.0 | SCALE 1:8 | SEITE 9 / 17 |

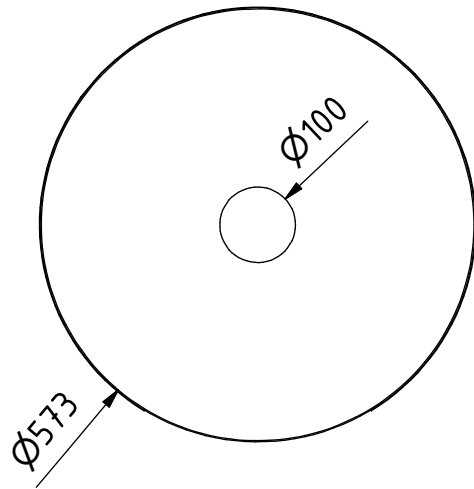
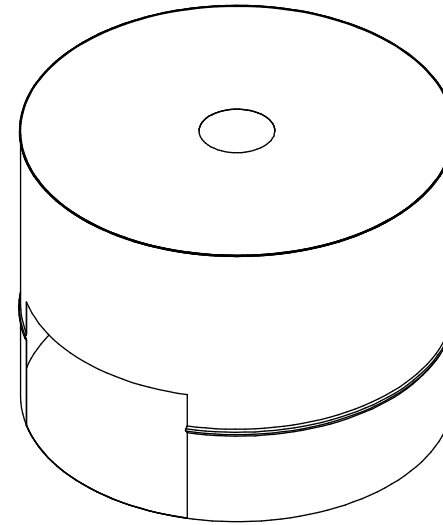
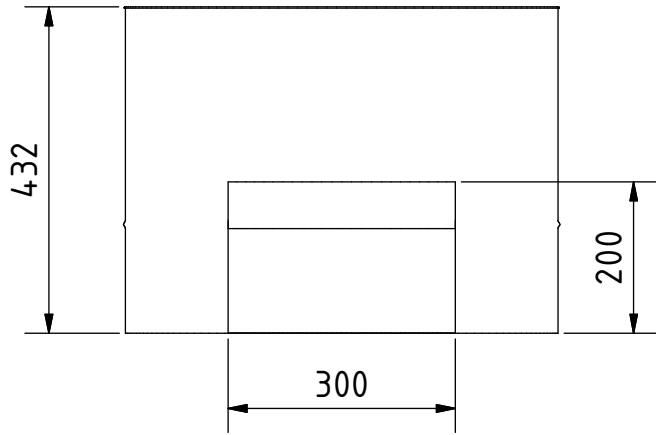

Hinweis: Alle einheiten in mm.

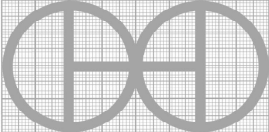
| | | | | |
|--|--|-----------------------------|--|------------------|
| PROJEKT Trommel Fischtrockner Räucherer | ERSTELLT VON J. Zeron | GENEHMIGT VON A. Morillo | DATE 08/06/2021 | VERSION 1.0 |
| TEIL-NAME Feuertrommel | DATEI-NAME Fire drum.ipt | | | TEIL-CODE 7 |
| ENTWICKELT VON INTERNATIONAL LABOUR OFFICE | UMGESTALTET VON  OHO e.V. | DOK. TYP PART | WERKSTOFF Schrottfässer aus Metall | MENGE 1 |
| | | LIZENZ CC-BY-SA 4.0 | SCALE 1:10 | SEITE 10 / 17 |

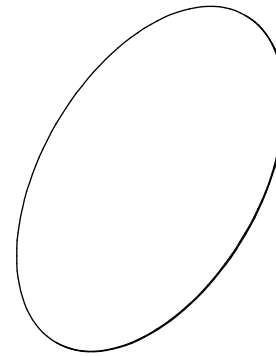
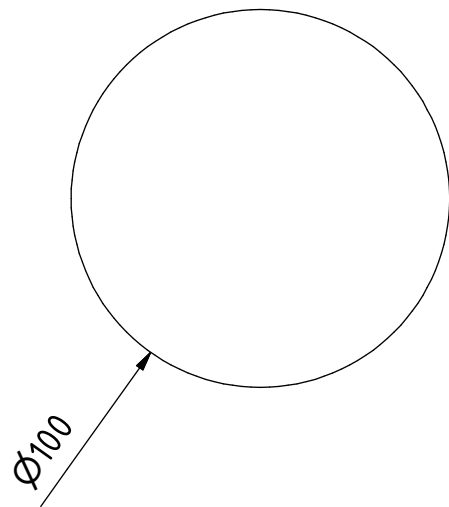

Hinweis: Alle einheiten in mm.

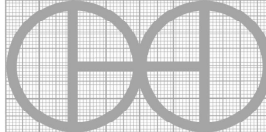
| | | | | |
|--|--|-----------------------------|--|-----------------|
| PROJEKT Trommel Fischtrockner Räucherer | ERSTELLT VON J. Zeron | GENEHMIGT VON A. Morillo | DATE 08/06/2021 | VERSION 1.0 |
| TEIL-NAME Obere Düse | DATEI-NAME Upper nozzle.ipt | | | TEIL-CODE 9 |
| ENTWICKELT VON INTERNATIONAL LABOUR OFFICE | UMGESTALTET VON  OHO e.V. | DOK. TYP PART | WERKSTOFF Schrottfässer aus Metall | MENGE 1 |
| | | LIZENZ CC-BY-SA 4.0 | SCALE 1:2 | SEITE 11 /17 |

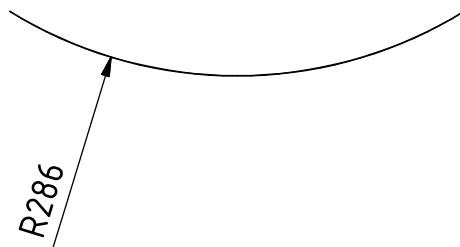
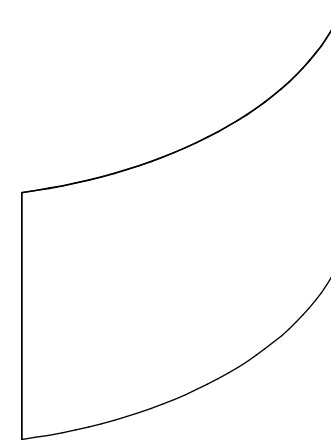
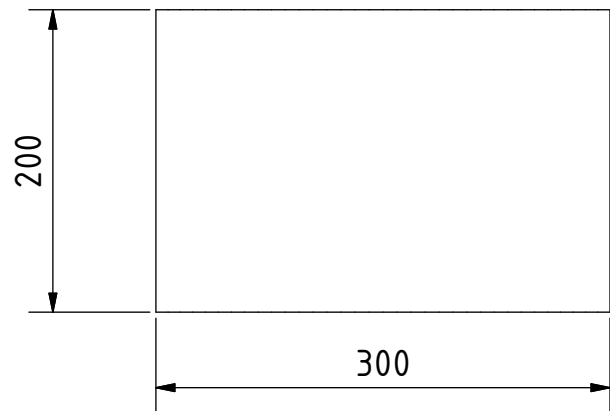

Hinweis: Alle einheiten in mm.

| | | | | |
|--|--|-----------------------------|--|------------------|
| PROJEKT Trommel Fischtrockner Räucherer | ERSTELLT VON J. Zeron | GENEHMIGT VON A. Morillo | DATE 08/06/2021 | VERSION 1.0 |
| TEIL-NAME Seitlicher Einlass | DATEI-NAME Side entrance.ipt | | | TEIL-CODE 10 |
| ENTWICKELT VON INTERNATIONAL LABOUR OFFICE | UMGESTALTET VON  OHO e.V. | DOK. TYP PART | WERKSTOFF Schrottfässer aus Metall | MENGE 1 |
| | | LIZENZ CC-BY-SA 4.0 | SCALE 1:5 | SEITE 12 / 17 |

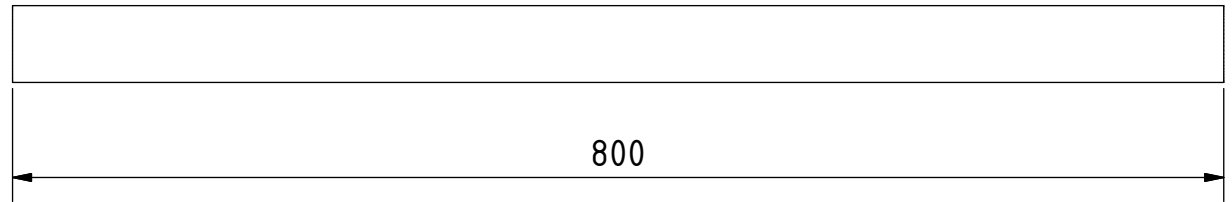
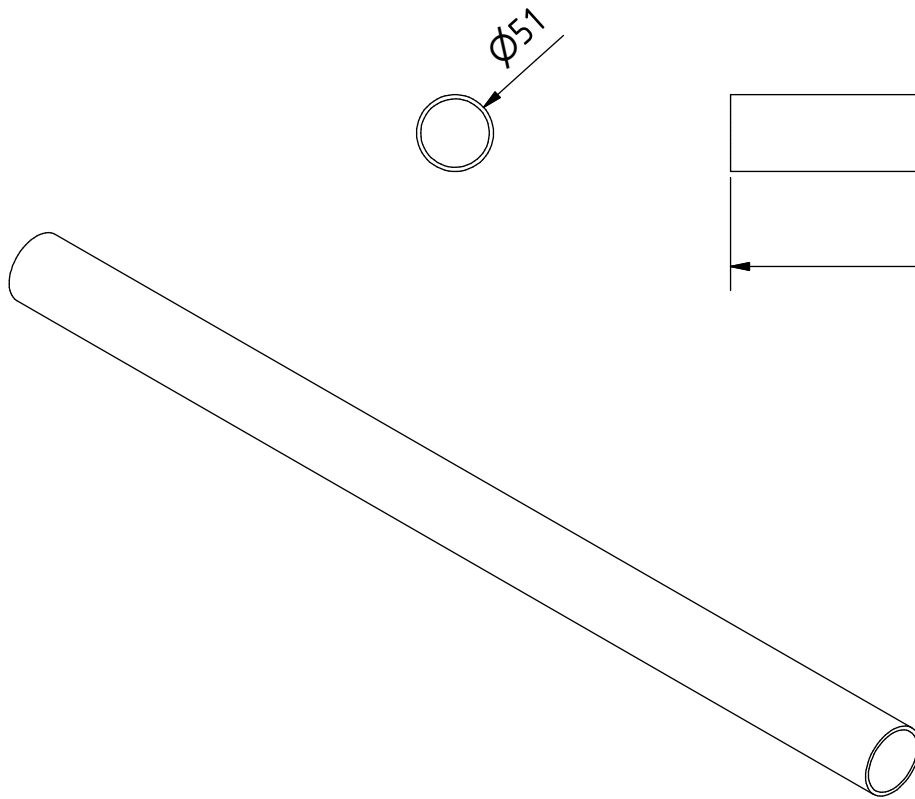

Hinweis: Alle einheiten in mm.

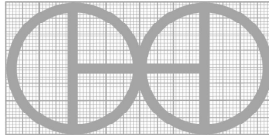
| | | | | |
|--|--|--|--|--------------------------------|
| PROJEKT Trommel Fischtrockner Räucherer | ERSTELLT VON J. Zeron | GENEHMIGT VON A. Morillo | DATE 08/06/2021 | VERSION 1.0 |
| TEIL-NAME Rohr A | DATEI-NAME Tube A.ipt | | | TEIL-CODE 11 |
| ENTWICKELT VON INTERNATIONAL LABOUR OFFICE | UMGESTALTET VON  OHO e.V. | DOK. TYP PART LIZENZ CC-BY-SA 4.0 | WERKSTOFF Schwarzes Eisen SCALE 1:5 | MENGE 1 SEITE 13 / 17 |

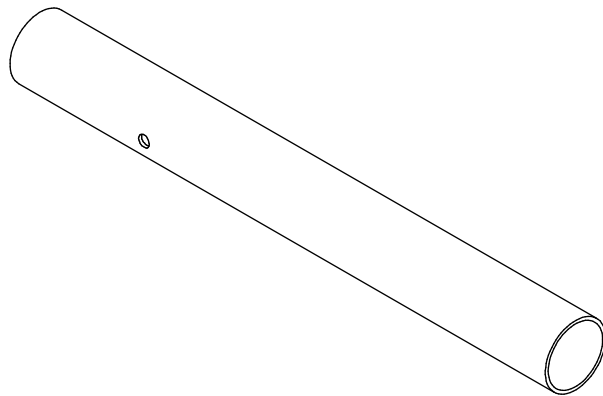
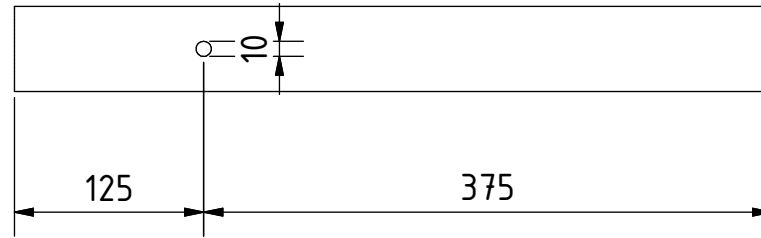
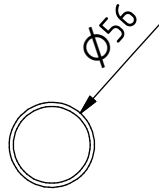

Hinweis: Alle einheiten in mm.

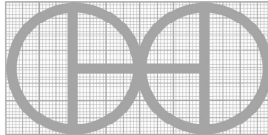
| | | | | |
|--|--|-----------------------------|------------------------------|------------------|
| PROJEKT Trommel Fischtrockner Räucherer | ERSTELLT VON J. Zeron | GENEHMIGT VON A. Morillo | DATE 08/06/2021 | VERSION 1.0 |
| TEIL-NAME Rohr B | DATEI-NAME Tube B.ipt | | | TEIL-CODE 12 |
| ENTWICKELT VON INTERNATIONAL LABOUR OFFICE | UMGESTALTET VON  OHO e.V. | DOK. TYP PART | WERKSTOFF Schwarzes Eisen | MENGE 1 |
| | | LIZENZ CC-BY-SA 4.0 | SCALE 1:5 | SEITE 14 / 17 |

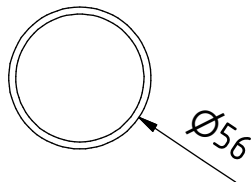
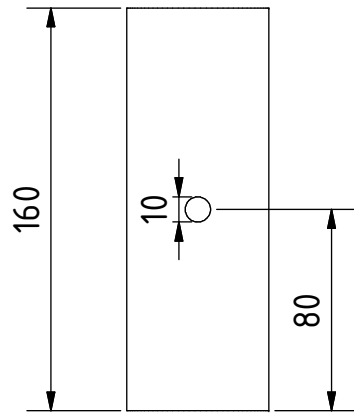

Hinweis: Alle einheiten in mm.

| | | | | |
|--|--|-----------------------------|------------------------------|------------------|
| PROJEKT Trommel Fischtrockner Räucherer | ERSTELLT VON J. Zeron | GENEHMIGT VON A. Morillo | DATE 08/06/2021 | VERSION 1.0 |
| TEIL-NAME Rohr C | DATEI-NAME Tube C.ipt | | | TEIL-CODE 13 |
| ENTWICKELT VON INTERNATIONAL LABOUR OFFICE | UMGESTALTET VON  OHO e.V. | DOK. TYP PART | WERKSTOFF Schwarzes Eisen | MENGE 1 |
| | | LIZENZ CC-BY-SA 4.0 | SCALE 1:3 | SEITE 15 / 17 |

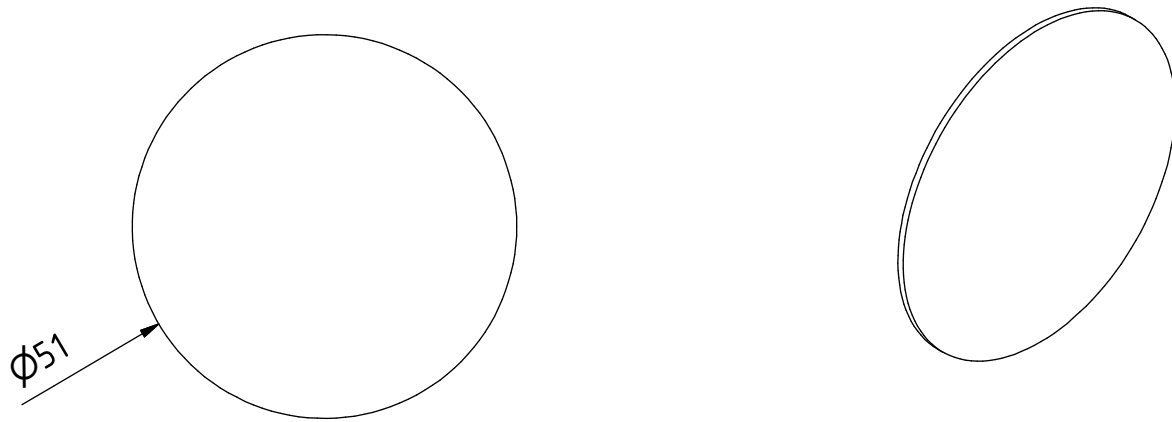

Hinweis: Alle einheiten in mm.

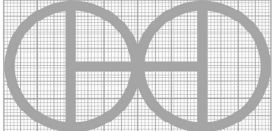
| | | | | |
|--|--|-----------------------------|---------------------|------------------|
| PROJEKT Trommel Fischtrockner Räucherer | ERSTELLT VON J. Zeron | GENEHMIGT VON A. Morillo | DATE 08/06/2021 | VERSION 1.0 |
| TEIL-NAME Düse | DATEI-NAME Nozzle.ipt | | | TEIL-CODE 14 |
| ENTWICKELT VON INTERNATIONAL LABOUR OFFICE | UMGESTALTET VON  OHO e.V. | DOK. TYP PART | WERKSTOFF Bleche | MENGE 2 |
| | | LIZENZ CC-BY-SA 4.0 | SCALE 1:1 | SEITE 16 / 17 |

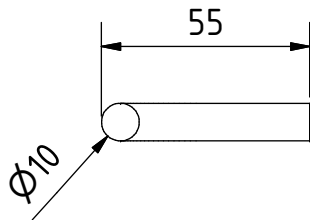
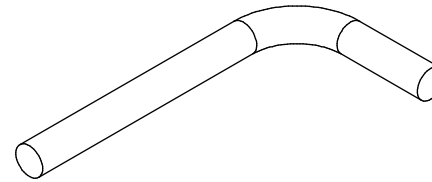
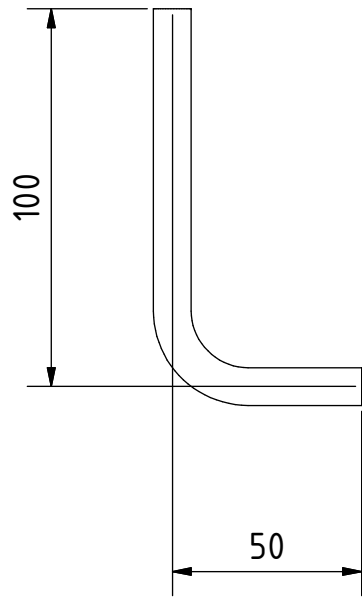

Hinweis: Alle einheiten in mm.

| | | | | |
|--|-----------------------------|-----------------------------|-------------------------|------------------|
| PROJEKT Trommel Fischtrockner Räucherer | ERSTELLT VON J. Zeron | GENEHMIGT VON A. Morillo | DATE 08/06/2021 | VERSION 1.0 |
| TEIL-NAME Bar | DATEI-NAME Bar.ipt | | | TEIL-CODE 15 |
| ENTWICKELT VON INTERNATIONAL LABOUR OFFICE | UMGESTALTET VON OHO e.V. | DOK. TYP PART | WERKSTOFF Flacheisen | MENGE 2 |
| | | LIZENZ CC-BY-SA 4.0 | SCALE 1:2 | SEITE 17 / 17 |