







PROJECT BEE HIVE	CREATED BY A. PARDO	APPROVED BY		
PART NAME BEE HIVE	PART CODE 1	DOCUMENT TYPE ASSEMBLY	MATERIAL WOOD	
 OPEN SOURCE ECOLOGY GERMANY	LICENSE 	FILE NAME BEE HIVE.iam	VERSION 1.0	QUANTITY 1
		SCALE 1 / 19	SHEET 1/30	DATE 25/9/2020

PARTS LIST						
POS.	POS. OLD	QTY	PART ANME	FILE NAME	PART TYPE	SPECIFICATIONS
1		1	BEE HIVE	BEE HIVE	ASSEMBLY	
1.1		1	PARTS LIST	BROOD CHAMBER.iam	ASSEMBLY	
1.2		1	BROOD CHAMBER	BROOD CHAMBER.iam	ASSEMBLY	
1.3		1	BROOD CHAMBER A	BROOD CHAMBER A.ipt	PART	
1.4		2	BROOD CHAMBER B	BROOD CHAMBER B.ipt	PART	
2		1	REVERSIBLE BOTTOM BOARD	REVERSIBLE BOTTOM BOARD.iam	ASSEMBLY	
2.1		1	REVERSIBLE BOTTOM BOARD A	REVERSIBLE BOTTOM BOARD A.ipt	PART	
2.2		1	REVERSIBLE BOTTOM BOARD B	REVERSIBLE BOTTOM BOARD B.ipt	PART	
2.3		1	REVERSIBLE BOTTOM BOARD C	REVERSIBLE BOTTOM BOARD C.ipt	PART	
2.4		1	REVERSIBLE BOTTOM BOARD D	REVERSIBLE BOTTOM BOARD D.ipt	PART	
2.5		1	REVERSIBLE BOTTOM BOARD E	REVERSIBLE BOTTOM BOARD E.ipt	PART	
3		1	OUTER COVER	OUTER COVER.iam	ASSEMBLY	
3.1		1	OUTER COVER A	OUTER COVER A.ipt	PART	
3.2		2	OUTER COVER B	OUTER COVER B.ipt	PART	
3.3		2	OUTER COVER C	OUTER COVER C.ipt	PART	
4		1	INNER COVER	INNER COVER.iam	ASSEMBLY	
4.1		2	INNER COVER A	INNER COVER A.ipt	PART	
4.2		2	INNER COVER B	INNER COVER B.ipt	PART	
4.3		1	INNER COVER C	INNER COVER C.ipt	PART	
5		1	SHALLOW SUPER	SHALLOW SUPER.iam	ASSEMBLY	
5.1		2	SHALLOW SUPER A	SHALLOW SUPER A.ipt	PART	
5.2		2	SHALLOW SUPER B	SHALLOW SUPER B.ipt	PART	
6		1	BROOD FRAME	BROOD FRAME.iam	ASSEMBLY	
6.1		1	BROOD FRAME A	BROOD FRAME A.ipt	PART	
6.2		2	BROOD FRAME B	BROOD FRAME B.ipt	PART	
6.3		1	BROOD FRAME C	BROOD FRAME C.ipt	PART	
7		1	SHALLOW SUPER FRAME	SHALLOW SUPER FRAME.iam	ASSEMBLY	
6.1		1	BROOD FRAME A	BROOD FRAME A	PART	
6.2		1	BROOD FRAME B	BROOD FRAME B	PART	
7.1		2	SHALLOW SUPER FRAME A	SHALLOW SUPER FRAME A.ipt	PART	

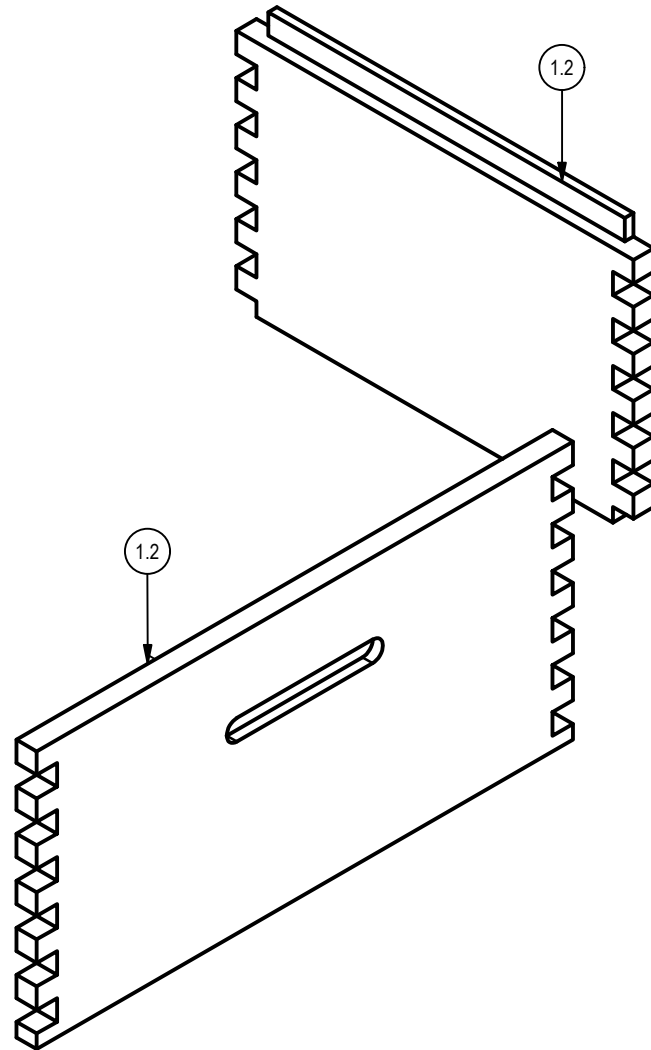
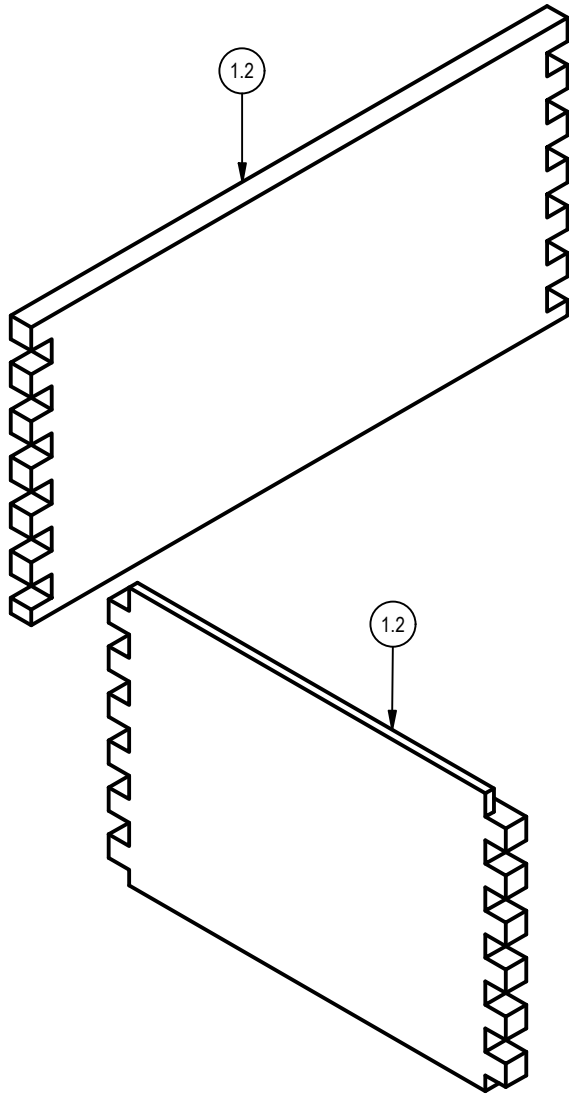

PROJECT BEE HIVE		CREATED BY A. PARDO		APPROVED BY	
PART NAME BEE HIVE		PART CODE 1.1		DOCUMENT TYPE PART LIST	
		LICENSE 		MATERIAL WOOD	
		FILE NAME PART LIST BEE HIVE.iam		VERSION 1.0	QUANTITY 1
		SCALE		SHEET 2/28	DATE 1/10/2020



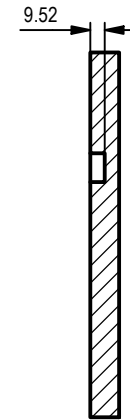
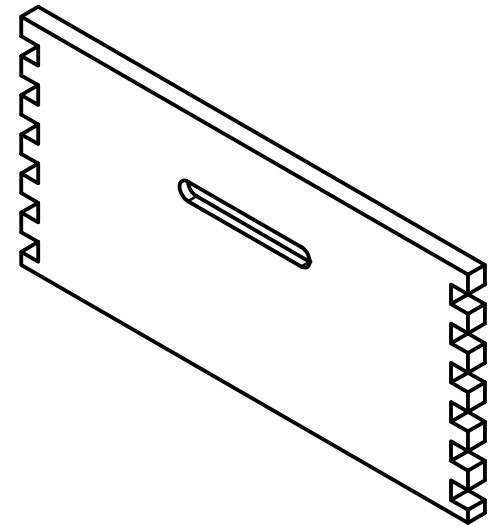
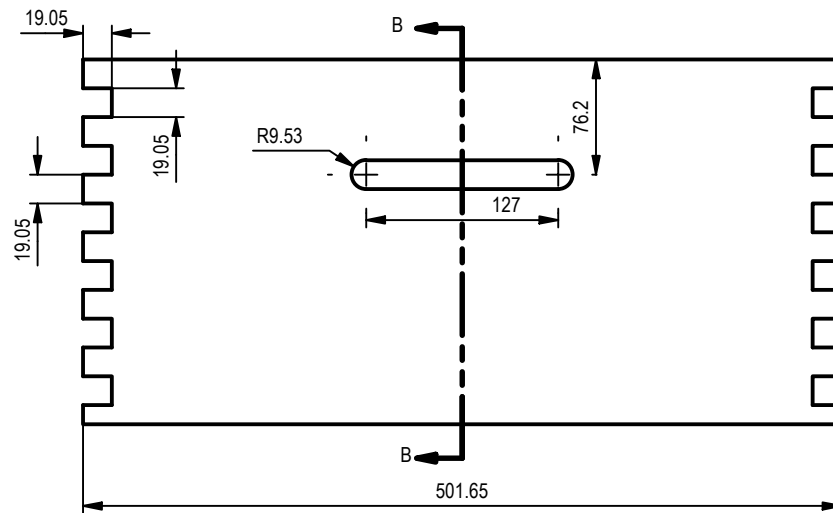
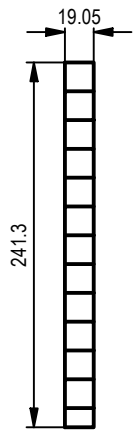

PROJECT BEE HIVE	CREATED BY A. PARDO	APPROVED BY		
PART NAME BROOD CHAMBER	PART CODE 1.2	DOCUMENT TYPE ASSEMBLY	MATERIAL WOOD	
 OPEN SOURCE ECOLOGY GERMANY	LICENSE 	FILE NAME BROOD CHAMBER.iam	VERSION 1.0	QUANTITY 1
		SCALE 1 : 5	SHEET 3/28	DATE 25/9/2020



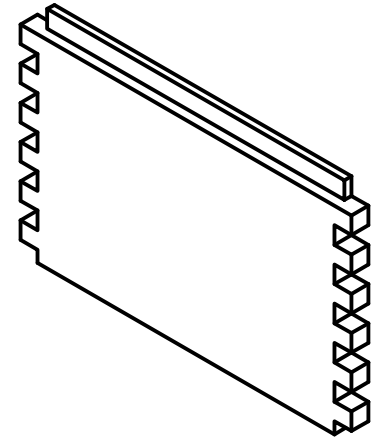
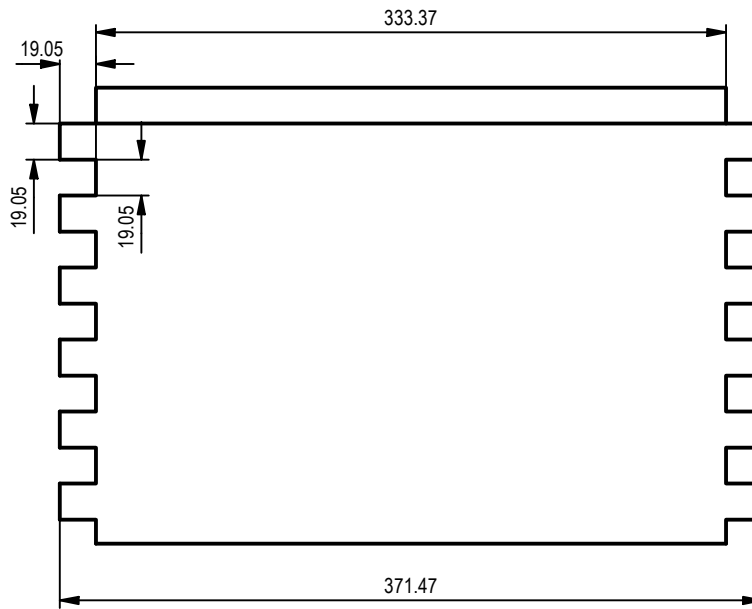
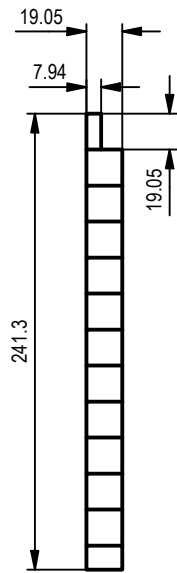

SECTION B-B
SCALE 1 / 5

PROJECT BEE HIVE	CREATED BY A. PARDO	APPROVED BY		
PART NAME BROOD CHAMBER A	PART CODE 1.3	DOCUMENT TYPE PART	MATERIAL WOOD	
 <p>OPEN SOURCE ECOLOGY GERMANY</p>	LICENSE 	FILE NAME BROOD CHAMBER A.ipt	VERSION 1.0	QUANTITY 1
		SCALE 1 / 5	SHEET 4/28	DATE 25/9/2020



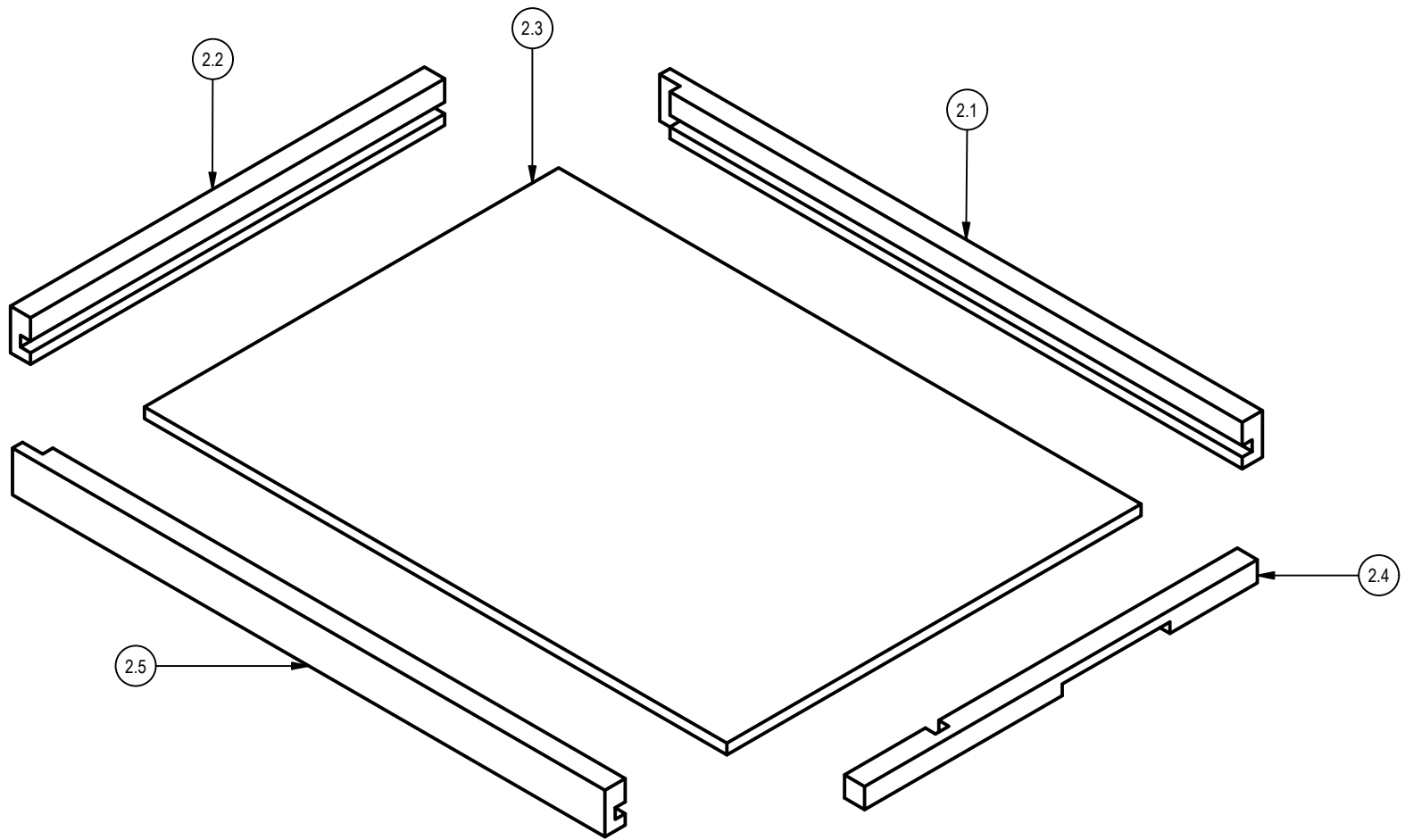

PROJECT BEE HIVE	CREATED BY A. PARDO	APPROVED BY		
PART NAME BROOD CHAMBER B	PART CODE 1.4	DOCUMENT TYPE PARTM	MATERIAL WOOD	
	LICENSE 	FILE NAME BROOD CHAMBER B.ipt	VERSION 1.0	QUANTITY 1
		SCALE 1 / 4	SHEET 5/30	DATE 25/9/2020



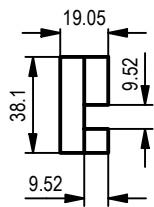
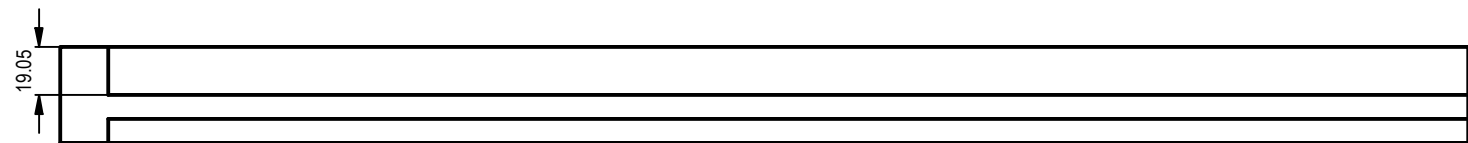
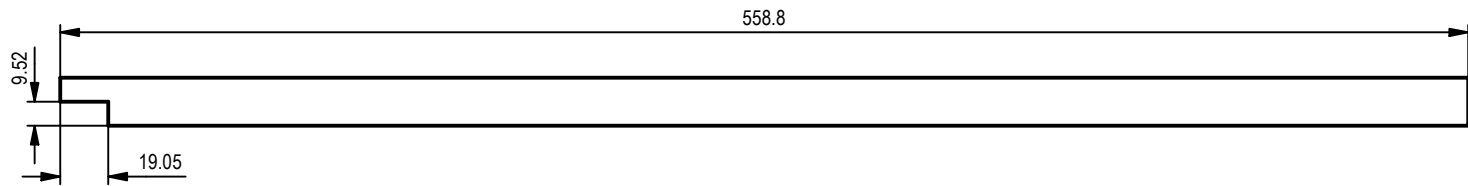
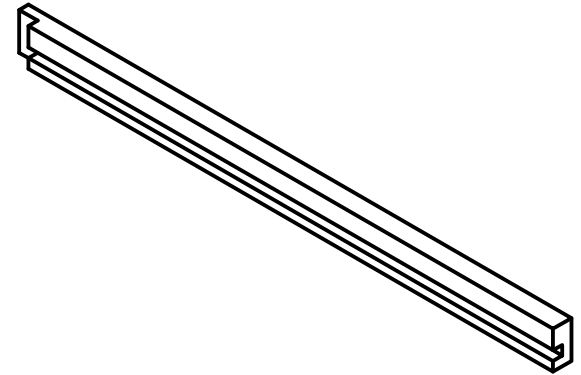

PROJECT BEE HIVE	CREATED BY A. PARDO	APPROVED BY		
PART NAME REVERSIBLE BOTTOM BOARD	PART CODE 2	DOCUMENT TYPE ASSEMBLY	MATERIAL WOOD	
	LICENSE 	FILE NAME REVERSIBLE BOTTOM BOARD.iam	VERSION 1.0	QUANTITY 1
		SCALE 1 / 4.5	SHEET 6/28	DATE 1/10/2020



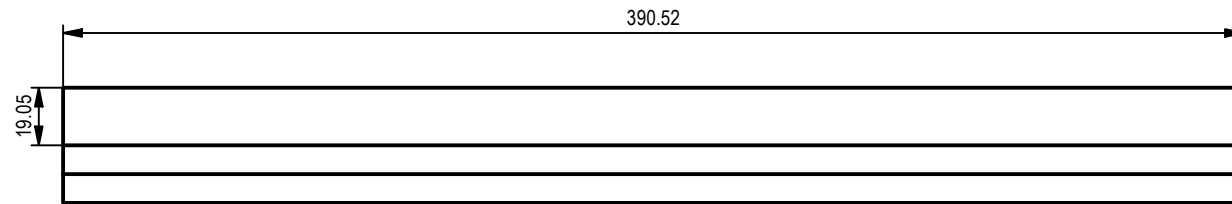
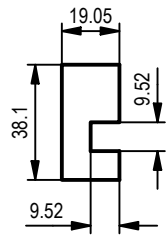
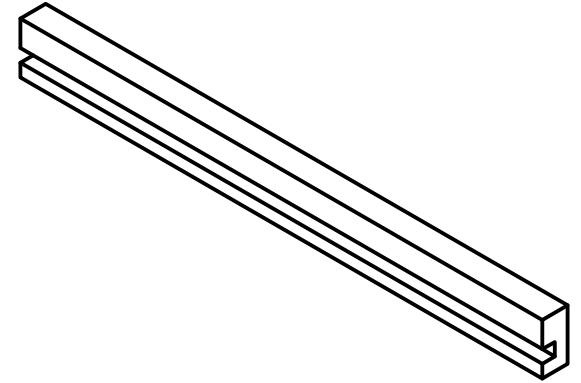

PROJECT BEE HIVE	CREATED BY A. PARDO	APPROVED BY		
PART NAME REVERSIBLE BOTTOM BOARD A	PART CODE 2.1	DOCUMENT TYPE PART	MATERIAL WOOD	
	LICENSE 	FILE NAME REVERSIBLE BOTTOM BOARD A.ipt	VERSION 1.0	QUANTITY 1
		SCALE 1 / 3	SHEET 7/28	DATE 25/9/2020



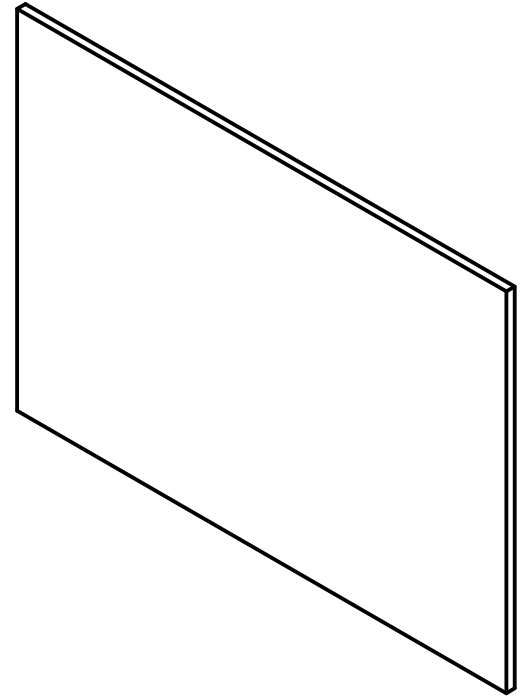
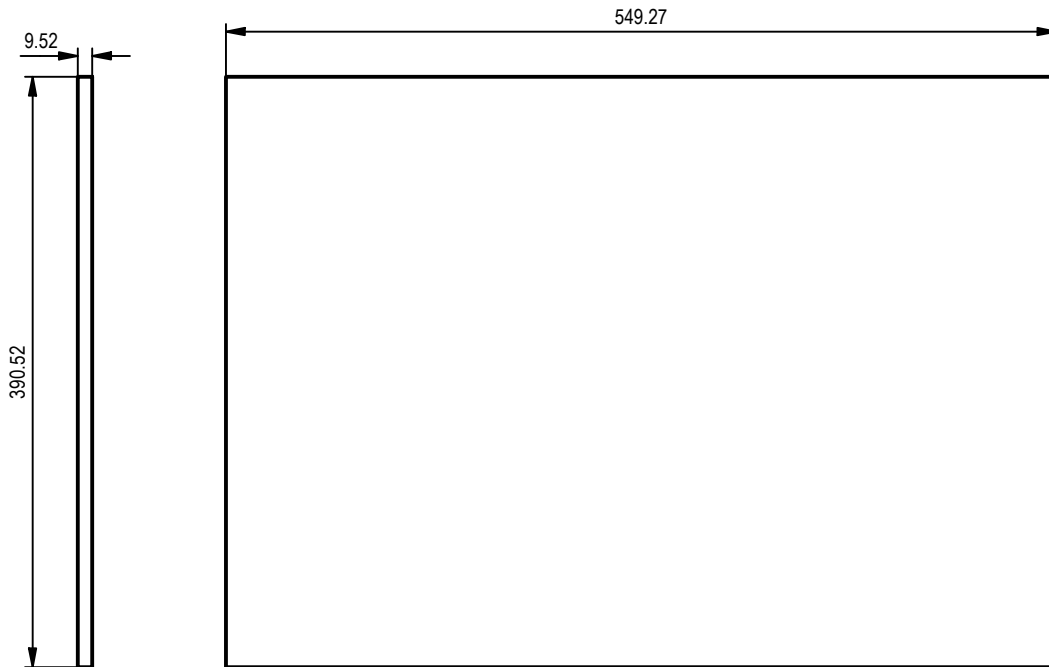

PROJECT BEE HIVE	CREATED BY A. PARDO	APPROVED BY		
PART NAME REVERSIBLE BOTTOM BOARD B	PART CODE 2.2	DOCUMENT TYPE PART	MATERIAL WOOD	
	LICENSE 	FILE NAME REVERSIBLE BOTTOM BOARD B.ipt	VERSION 1.0	QUANTITY 1
		SCALE 1 / 2.5	SHEET 8/28	DATE 25/9/2020



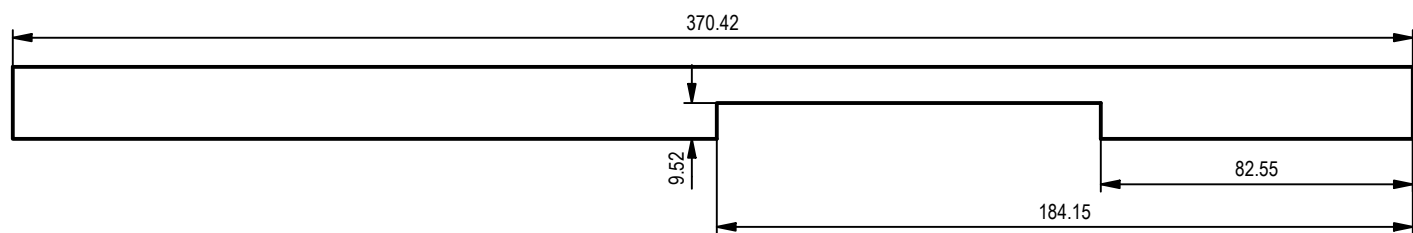
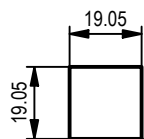
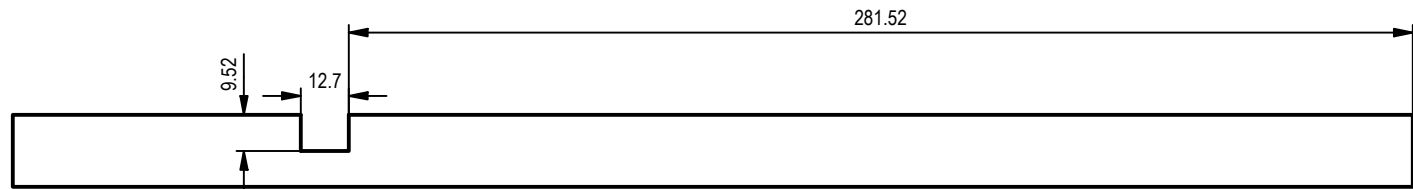
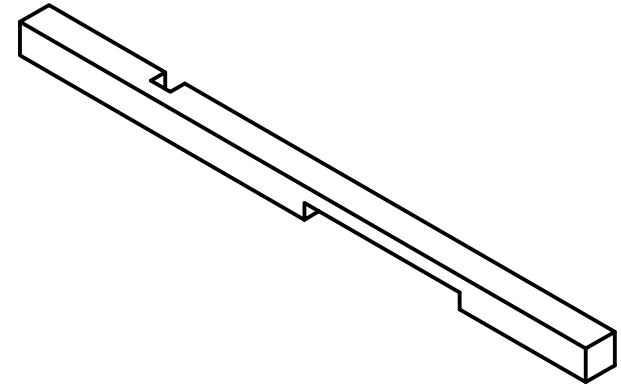

PROJECT BEE HIVE	CREATED BY A. PARDO	APPROVED BY		
PART NAME REVERSIBLE BOTTOM BOARD C	PART CODE 2.3	DOCUMENT TYPE PART	MATERIAL WOOD	
 <small>OPEN SOURCE ECOLOGY GERMANY</small>	LICENSE 	FILE NAME REVERSIBLE BOTTOM BOARD C.ipt	VERSION 1.0	QUANTITY 1
		SCALE 1 / 5	SHEET 9/28	DATE 25/9/2020



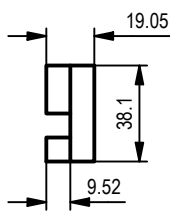
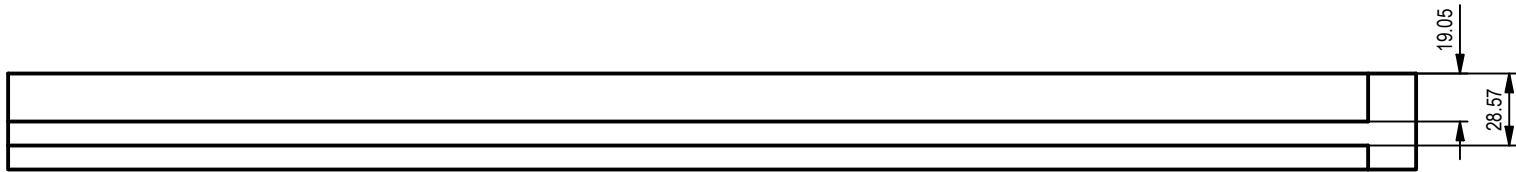
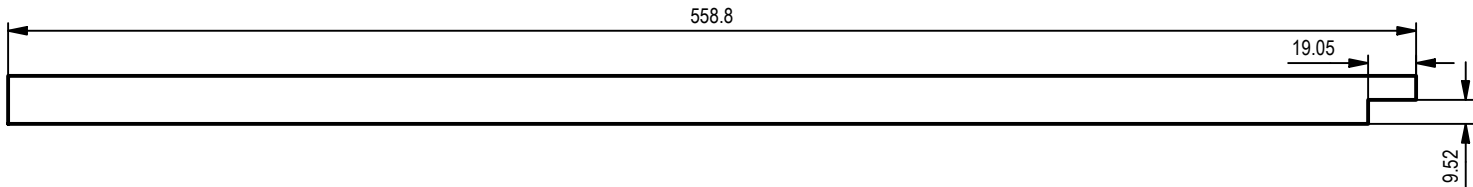
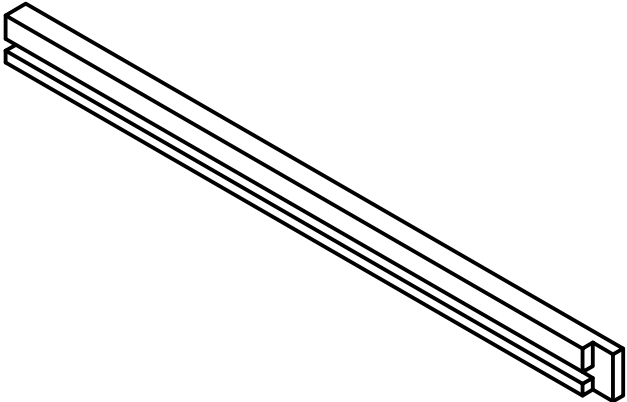

PROJECT BEE HIVE	CREATED BY A. PARDO	APPROVED BY		
PART NAME REVERSIBLE BOTTOM BOARD D	PART CODE 2.4	DOCUMENT TYPE PART	MATERIAL WOOD	
	LICENSE 	FILE NAME REVERSIBLE BOTTOM BOARD D.ipt	VERSION 1.0	QUANTITY 1
		SCALE 1 / 2	SHEET 10/28	DATE 25/9/2020



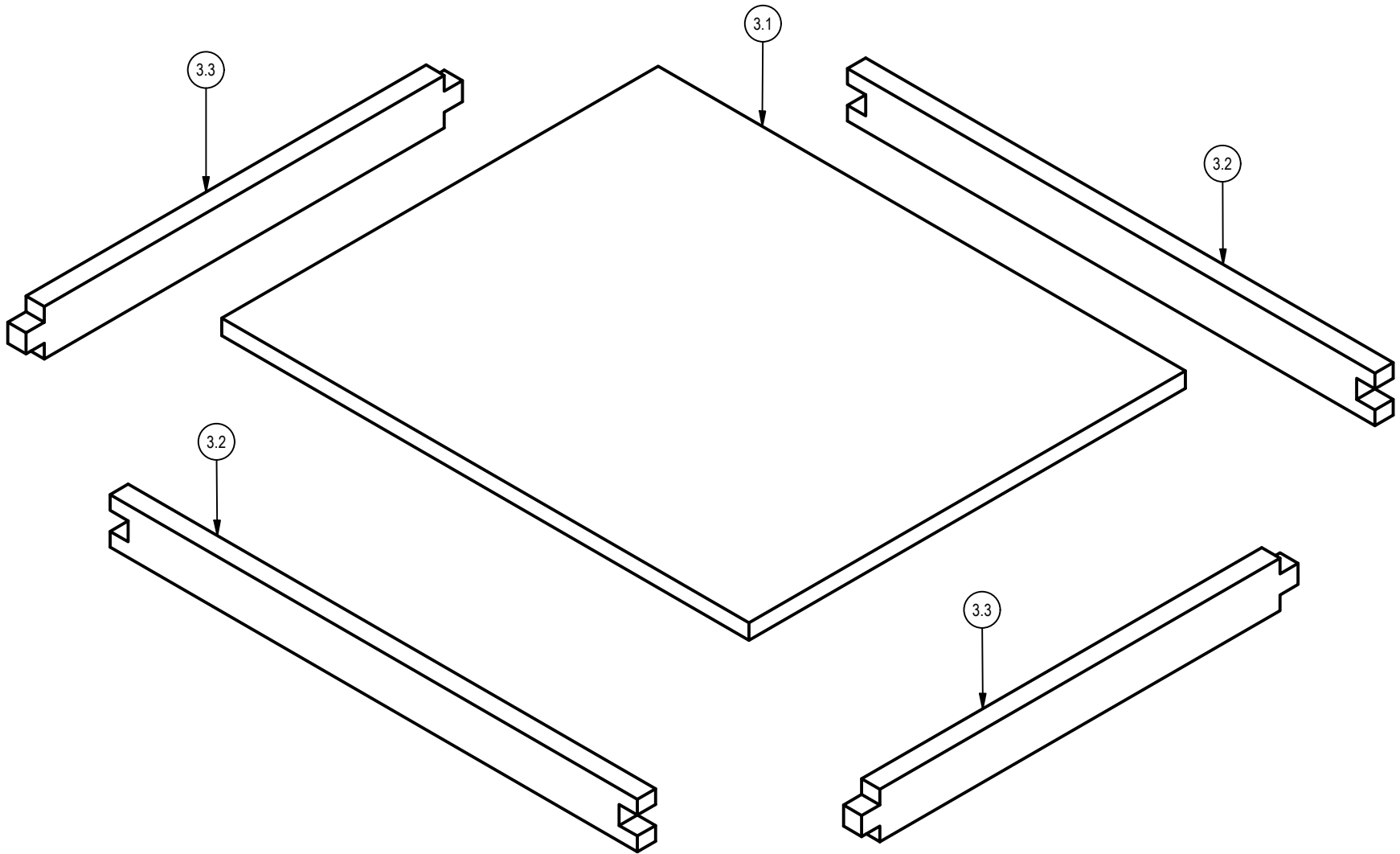

PROJECT BEE HIVE		CREATED BY A. PARDO		APPROVED BY	
PART NAME REVERSIBLE BOTTOM BOARD E		PART CODE 2.5		DOCUMENT TYPE PART	
		LICENSE 		MATERIAL WOOD	
		FILE NAME REVERSIBLE BOTTOM BOARD E.jst		VERSION 1.0	
		SCALE 1 / 3		QUANTITY 1	
		SHEET 11/28		DATE 25/9/2020	



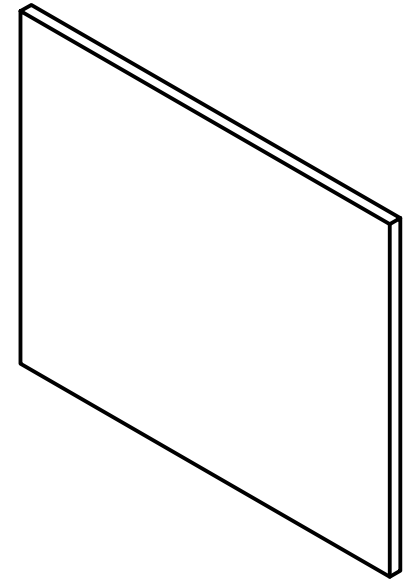
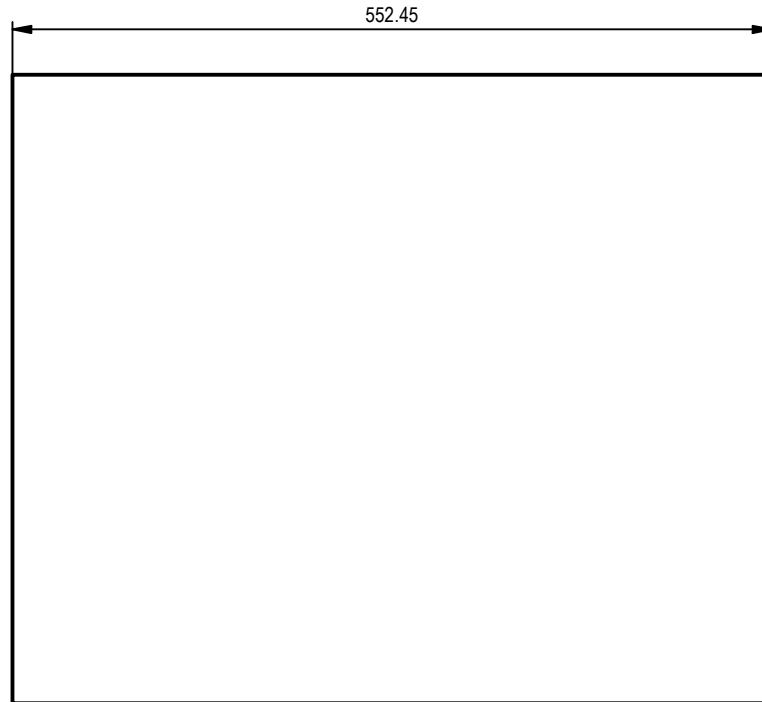
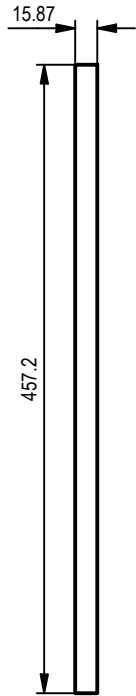

PROJECT BEE HIVE		CREATED BY A. PARDO		APPROVED BY	
PART NAME OUTER COVER		PART CODE 3		DOCUMENT TYPE ASSEMBLY	
 OPEN SOURCE ECOLOGY GERMANY		LICENSE 		MATERIAL WOOD	
		FILE NAME OUTER COVER.iam		VERSION 1.0	QUANTITY 1
		SCALE 1 / 4.5	SHEET 12/28	DATE 25/9/2020	



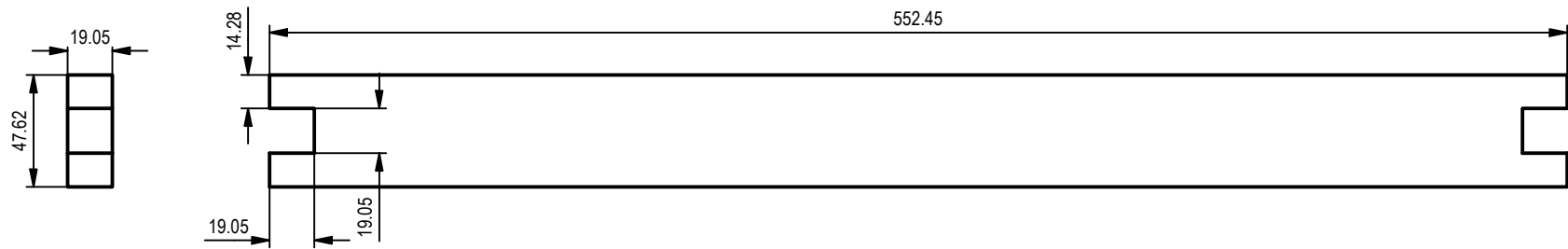
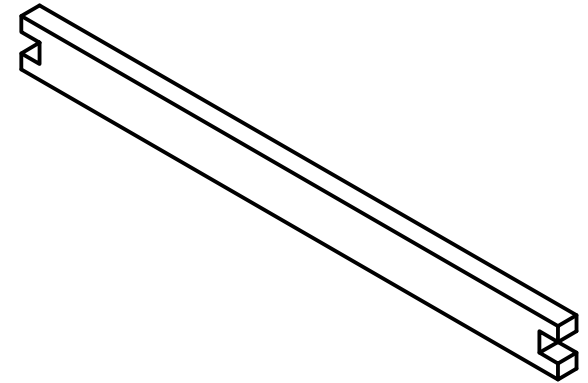

PROJECT BEE HIVE	CREATED BY A. PARDO	APPROVED BY		
PART NAME OUTER COVER A	PART CODE 3.1	DOCUMENT TYPE PART	MATERIAL WOOD	
 <small>OPEN SOURCE ECOLOGY GERMANY</small>	LICENSE 	FILE NAME OUTER COVER A.ipt	VERSION 1.0	QUANTITY 1
		SCALE 1 / 5.5	SHEET 13/28	DATE 25/9/2020



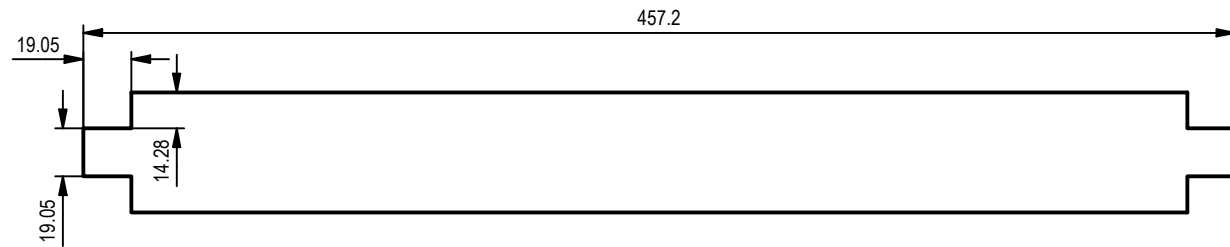
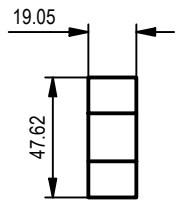
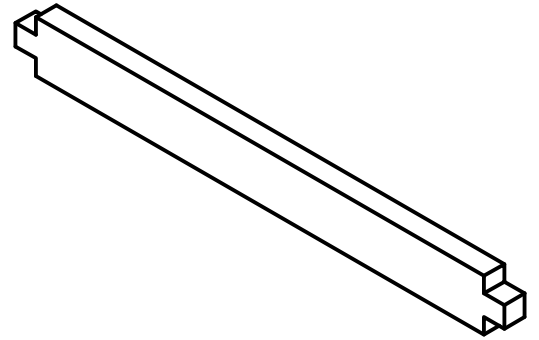

PROJECT BEE HIVE	CREATED BY A. PARDO	APPROVED BY		
PART NAME OUTER COVER B	PART CODE 3.2	DOCUMENT TYPE PART	MATERIAL WOOD	
	LICENSE 	FILE NAME OUTER COVER B.ipt	VERSION 1.0	QUANTITY 1
		SCALE 1 / 3	SHEET 14/28	DATE 25/9/2020



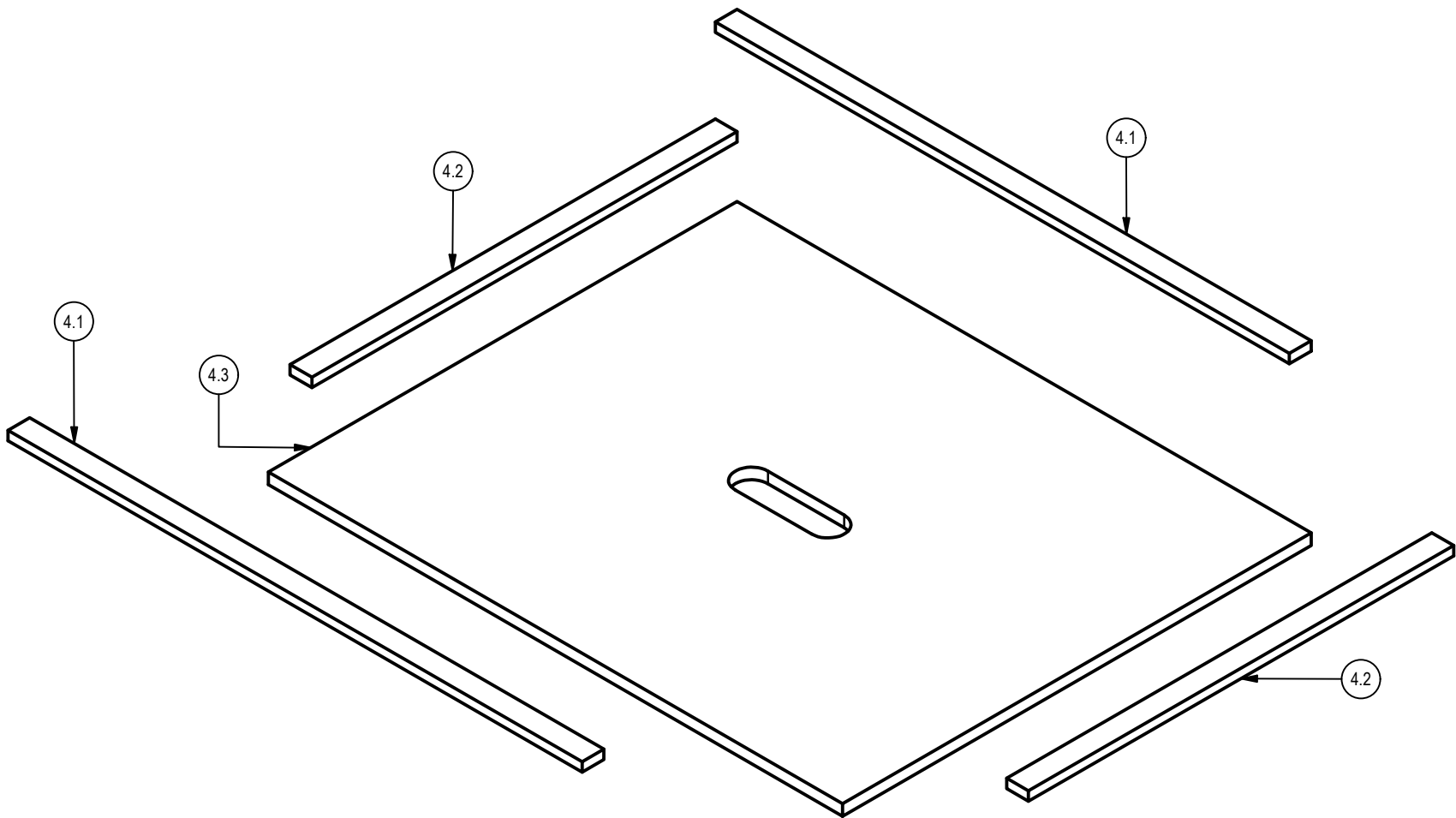

PROJECT BEE HIVE	CREATED BY A. PARDO	APPROVED BY		
PART NAME OUTER COVER C	PART CODE 3.3	DOCUMENT TYPE PART	MATERIAL WOOD	
 OPEN SOURCE ECOLOGY GERMANY	LICENSE 	FILE NAME OUTER COVER C.ipt	VERSION 1.0	QUANTITY 1
		SCALE 1 / 3	SHEET 15/28	DATE 25/9/2020



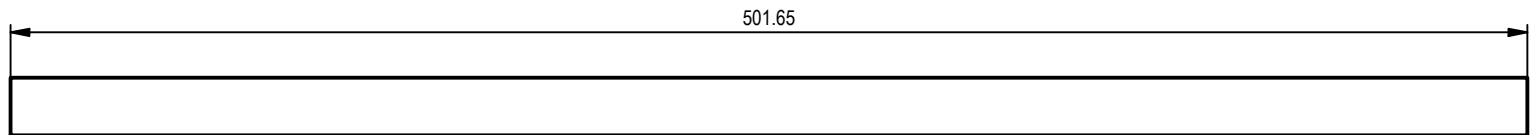
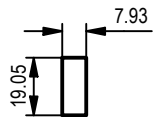
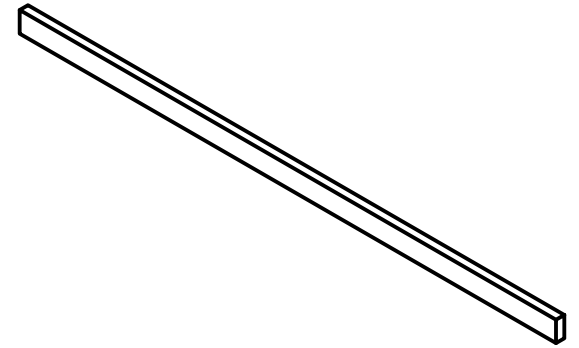

PROJECT BEE HIVE		CREATED BY A. PARDO		APPROVED BY	
PART NAME INNER COVER		PART CODE 4		DOCUMENT TYPE ASSEMBLY	
 OPEN SOURCE ECOLOGY GERMANY		LICENSE 		MATERIAL WOOD	
		FILE NAME INNER COVER.iam		VERSION 1.0	QUANTITY 1
		SCALE 1/4	SHEET 16/28	DATE 25/9/2020	



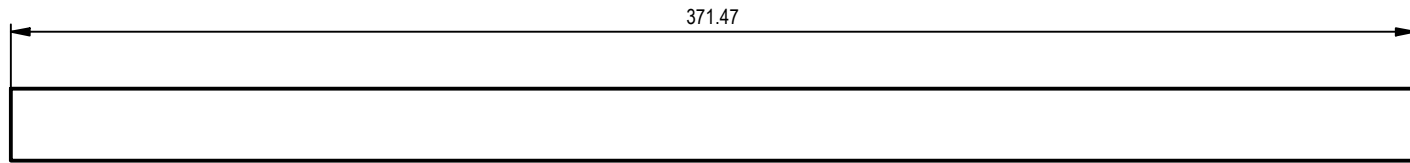
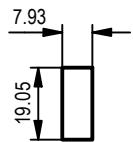
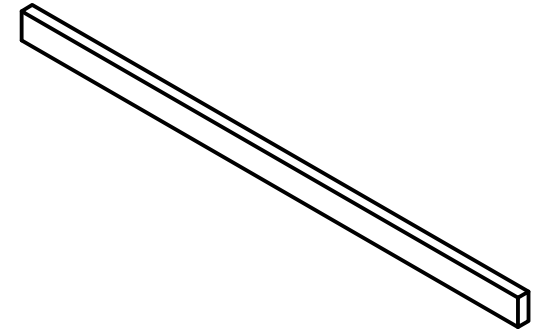

PROJECT BEE HIVE	CREATED BY A. PARDO	APPROVED BY		
PART NAME INNER COVER A	PART CODE 4.1	DOCUMENT TYPE PART	MATERIAL WOOD	
	LICENSE 	FILE NAME INNER COVER A.ipt	VERSION 1.0	QUANTITY 1
		SCALE 1 / 2.5	SHEET 17/28	DATE 25/9/2020



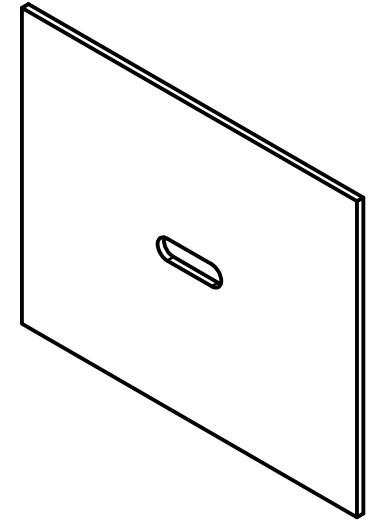
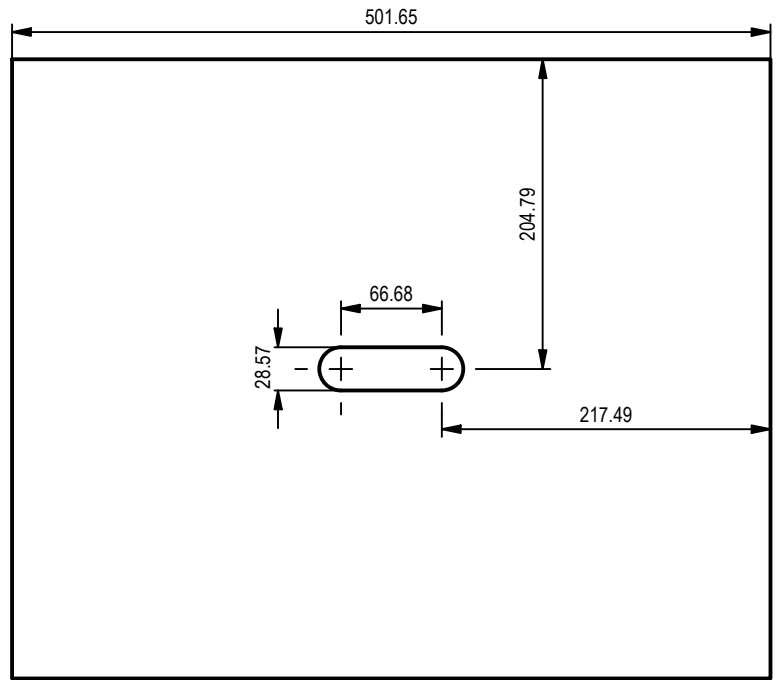
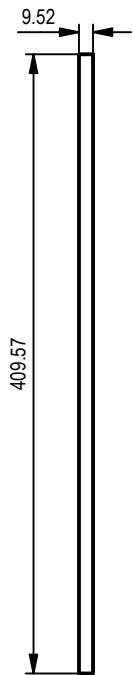

PROJECT BEE HIVE	CREATED BY A. PARDO	APPROVED BY		
PART NAME INNER COVER B	PART CODE 4.2	DOCUMENT TYPE PART	MATERIAL WOOD	
 OPEN SOURCE ECOLOGY GERMANY	LICENSE 	FILE NAME INNER COVER B.ipt	VERSION 1.0	QUANTITY 1
		SCALE 1 / 2	SHEET 18/28	DATE 25/9/2020



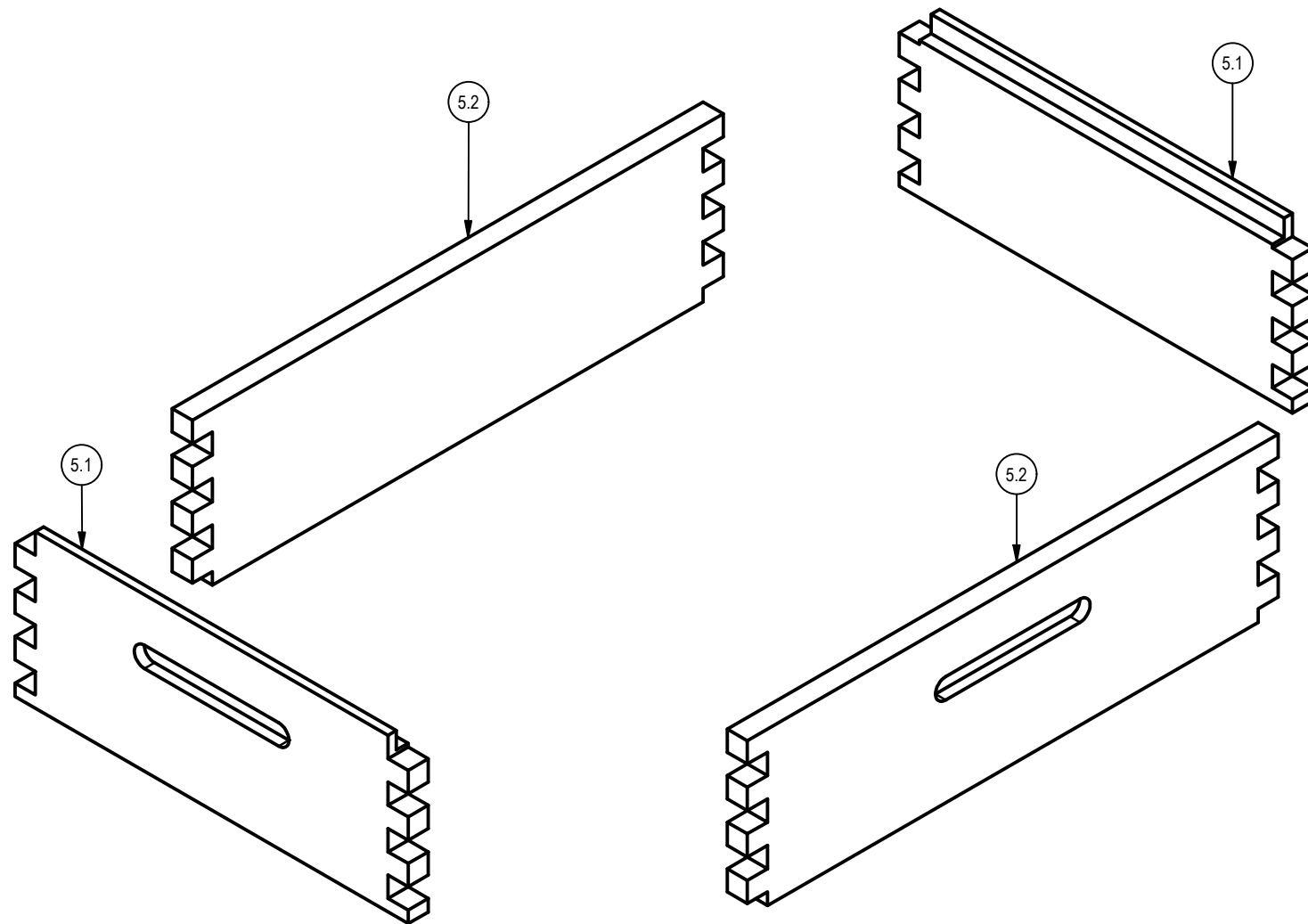

PROJECT BEE HIVE	CREATED BY A. PARDO	APPROVED BY		
PART NAME INNER COVER C	PART CODE 4.3	DOCUMENT TYPE PART	MATERIAL WOOD	
	LICENSE 	FILE NAME INNER COVER C.ipt	VERSION 1.0	QUANTITY 1
		SCALE 1 / 5	SHEET 19/28	DATE 25/9/2020



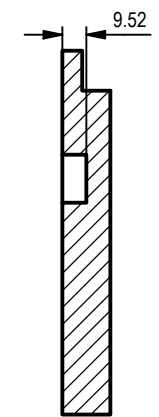
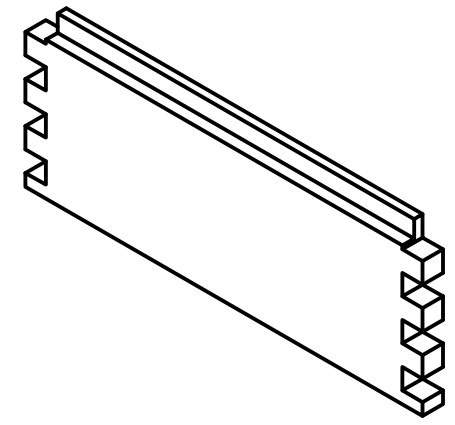
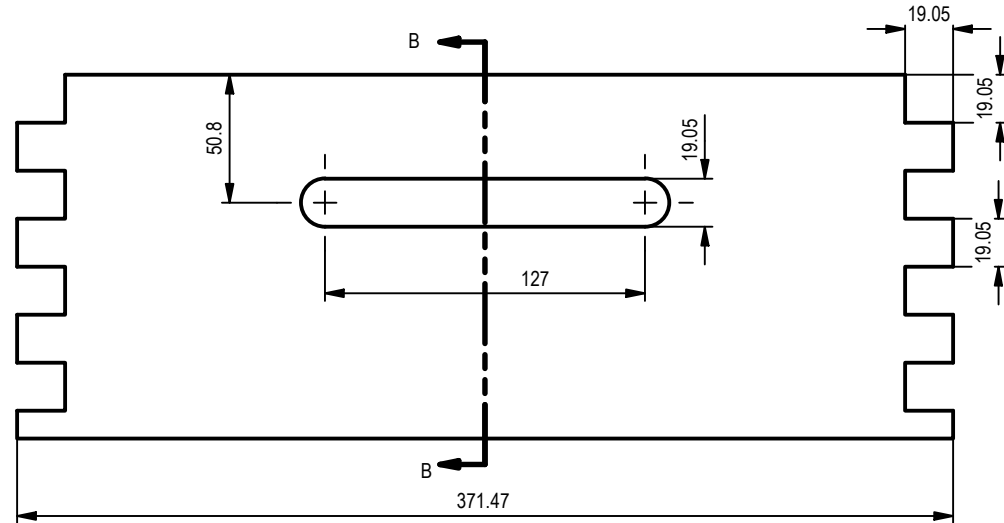
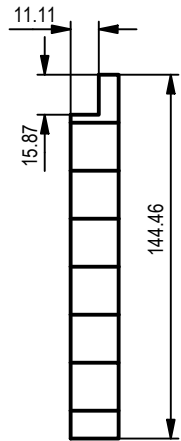

PROJECT BEE HIVE	CREATED BY A. PARDO	APPROVED BY		
PART NAME SHALLOW SUPER	PART CODE 5	DOCUMENT TYPE ASSEMBLY	MATERIAL WOOD	
 OPEN SOURCE ECOLOGY GERMANY	LICENSE 	FILE NAME SHALLOW SUPER.iam	VERSION 1.0	QUANTITY 1
		SCALE 1 : 4.5	SHEET 20/28	DATE 25/9/2020



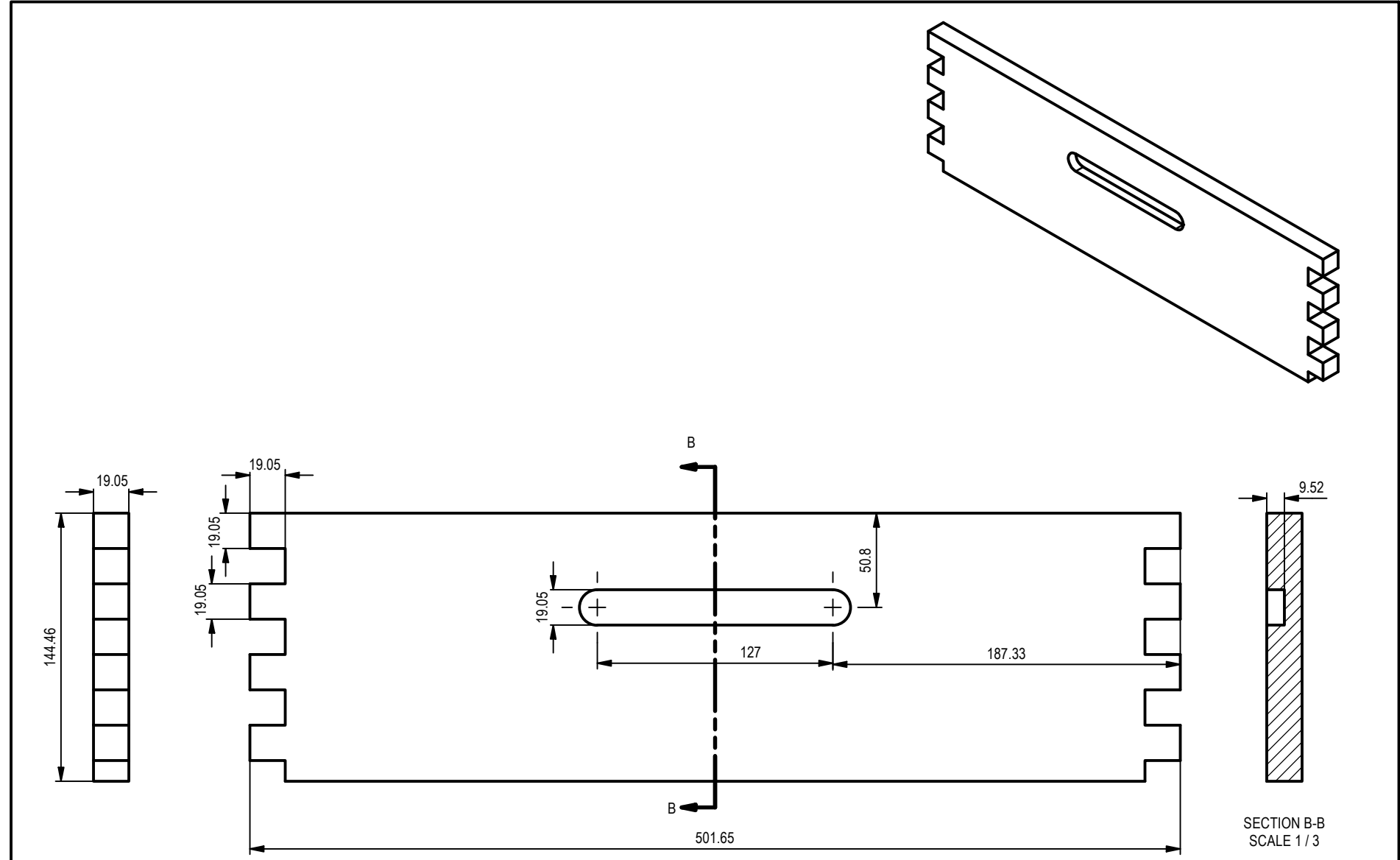

SECTION MD-MD
SCALE 1 / 3

PROJECT BEE HIVE	CREATED BY A. PARDO	APPROVED BY		
PART NAME SHALLOW SUPER A	PART CODE 5.1	DOCUMENT TYPE PART	MATERIAL WOOD	
	LICENSE 	FILE NAME SHALLOW SUPER A.ipt	VERSION 1.0	QUANTITY 1
		SCALE 1 / 3	SHEET 21/28	DATE 25/9/2020



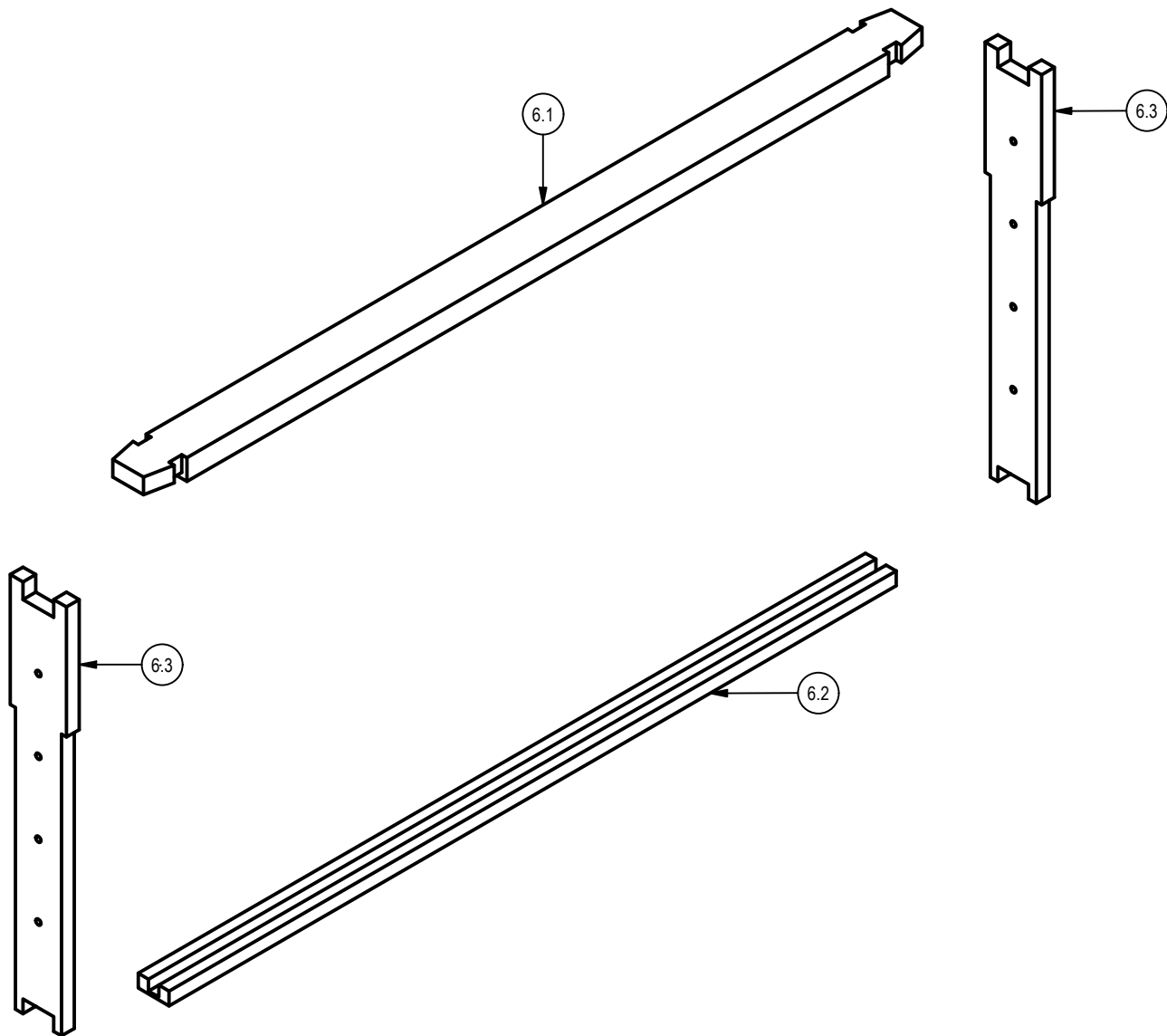

PROJECT BEE HIVE		CREATED BY A. PARDO		APPROVED BY	
PART NAME SHALLOW SUPER B		PART CODE 5.2		DOCUMENT TYPE PART	
		LICENSE 		MATERIAL WOOD	
		FILE NAME SHALLOW SUPER B.ipt		VERSION 1.0	QUANTITY 1
		SCALE 1 / 3	SHEET 22/28	DATE 25/9/2020	



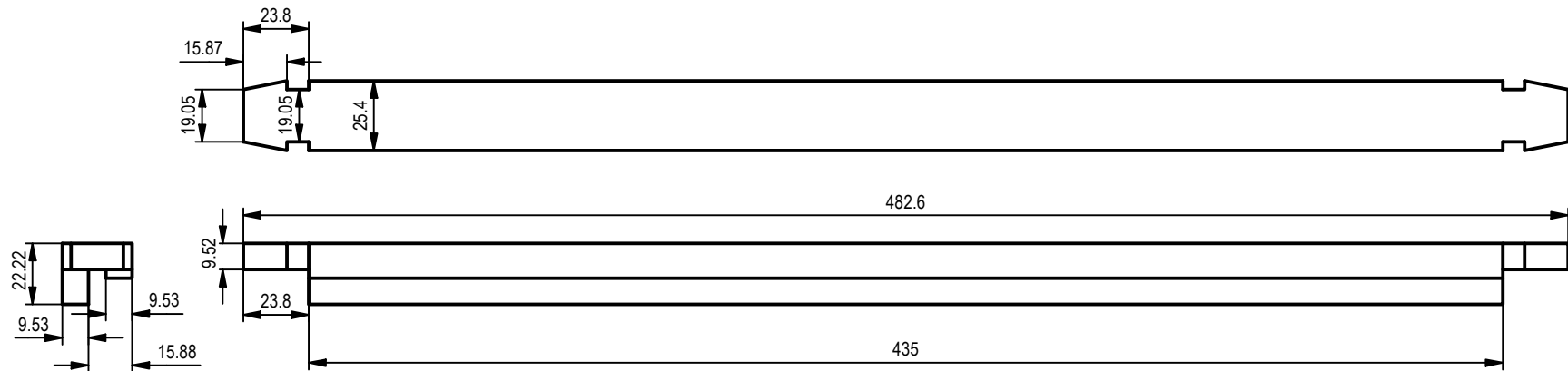
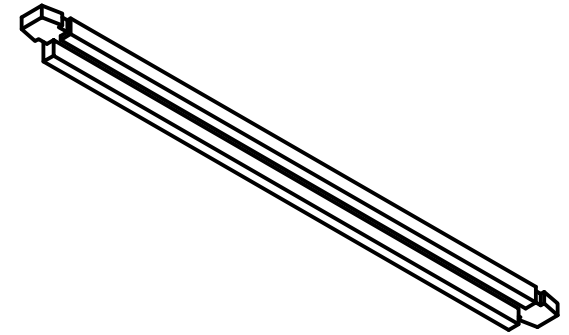

PROJECT BEE HIVE	CREATED BY A. PARDO	APPROVED BY		
PART NAME BROOD FRAME	PART CODE 6	DOCUMENT TYPE ASSEMBLY	MATERIAL WOOD	
 OPEN SOURCE ECOLOGY GERMANY	LICENSE 	FILE NAME BROOD FRAME.iam	VERSION 1.0	QUANTITY 1
		SCALE 1 : 3	SHEET 23/28	DATE 25/9/2020

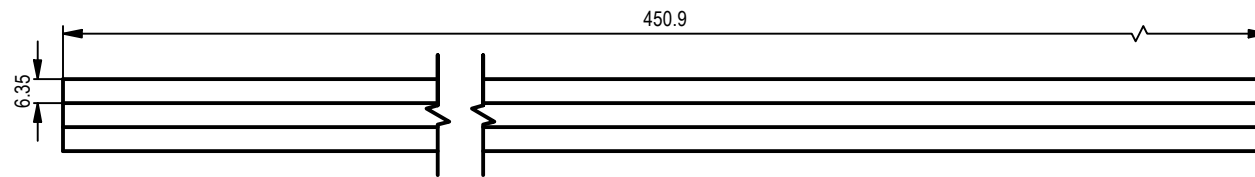
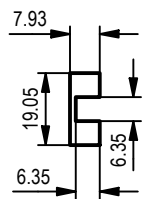
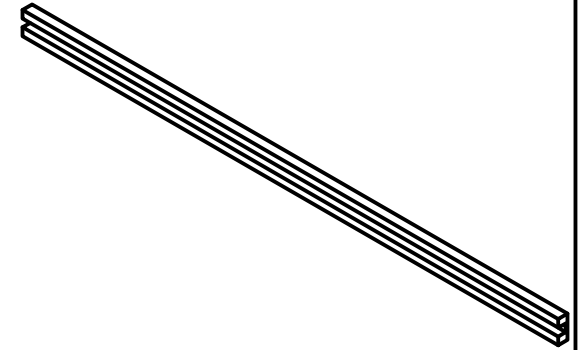

PROJECT BEE HIVE		CREATED BY A. PARDO		APPROVED BY	
PART NAME BROOD FRAME A		PART CODE 6.1	DOCUMENT TYPE PART		MATERIAL WOOD
		LICENSE 	FILE NAME BROOD FRAME A.ipt	VERSION 1.0	QUANTITY 1
			SCALE 1 / 2.5	SHEET 24/28	DATE 25/9/2020



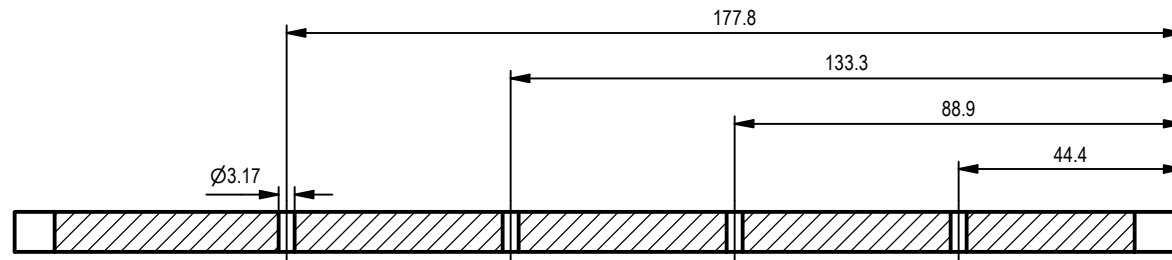
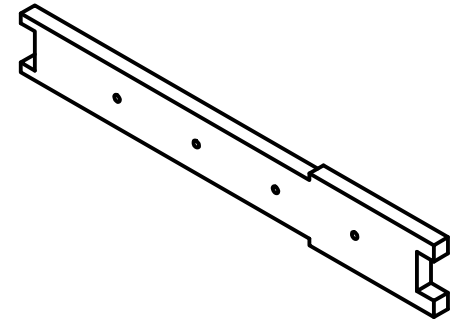

PROJECT BEE HIVE		CREATED BY A. PARDO		APPROVED BY	
PART NAME BROOD FRAME B		PART CODE 6.2	DOCUMENT TYPE PART		MATERIAL WOOD
 OPEN SOURCE ECOLOGY GERMANY		LICENSE 	FILE NAME BROOD FRAME B.ipt	VERSION 1.0	QUANTITY 1
			SCALE 1 / 2	SHEET 25/28	DATE 25/9/2020



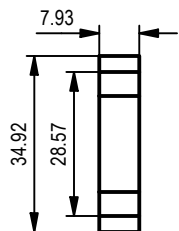
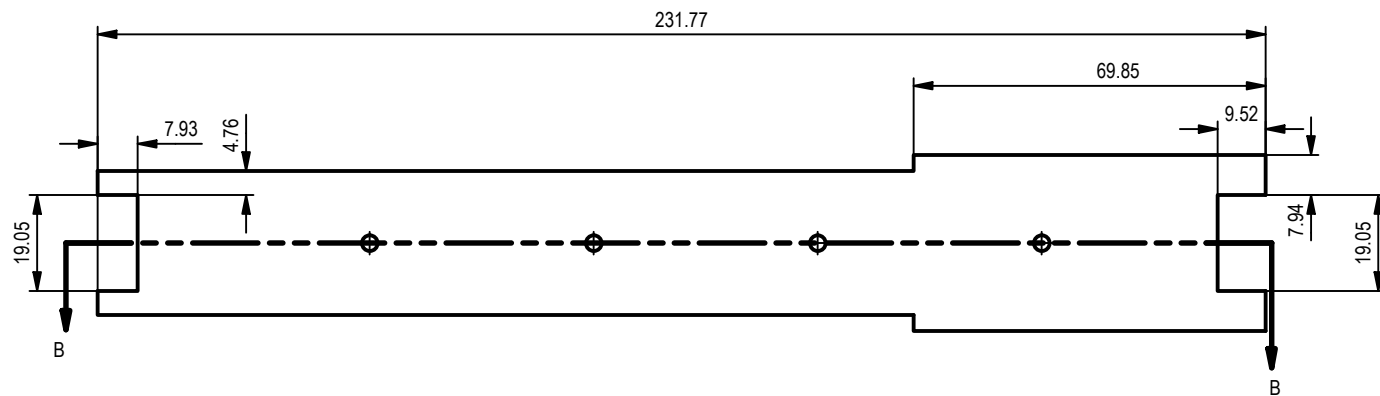

SECTION B-B
SCALE 1 / 1.5



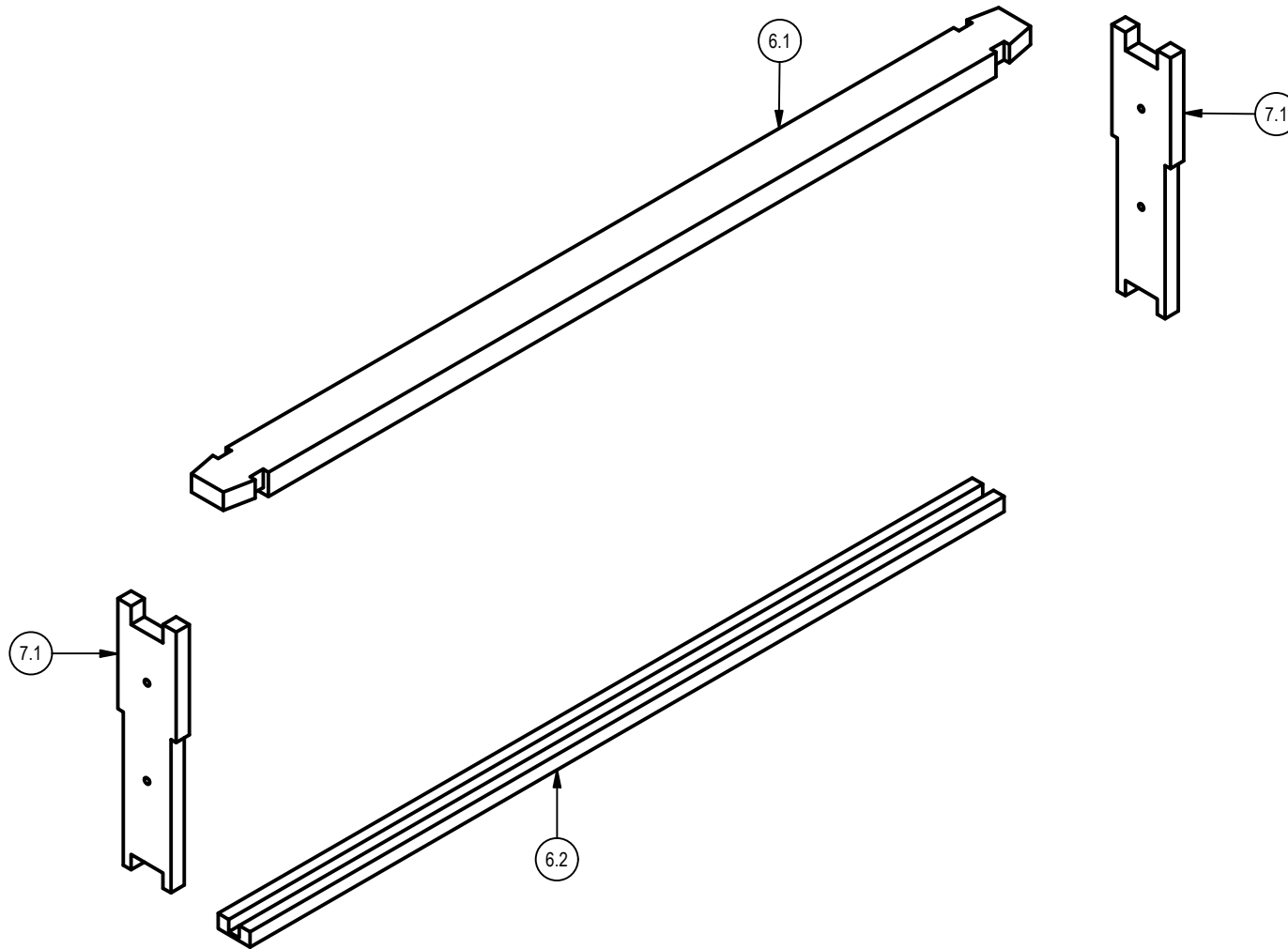

PROJECT BEE HIVE	CREATED BY A. PARDO	APPROVED BY		
PART NAME BROOD FRAME C	PART CODE 6.3	DOCUMENT TYPE PART	MATERIAL WOOD	
 OPEN SOURCE ECOLOGY GERMANY	LICENSE 	FILE NAME BROOD FRAME C.ipt	VERSION 1.0	QUANTITY 1
		SCALE 1 / 1.5	SHEET 26/28	DATE 25/9/2020

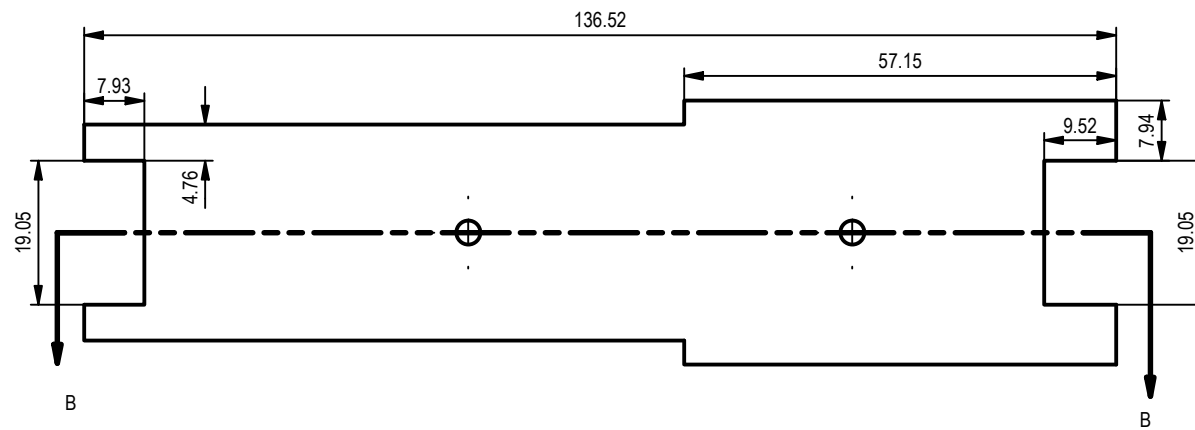
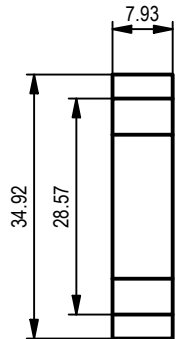
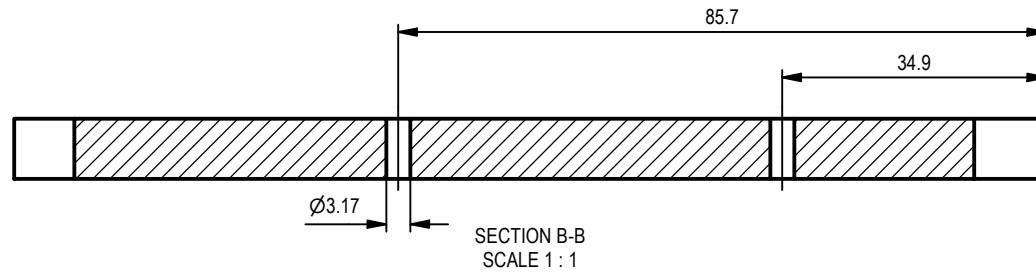
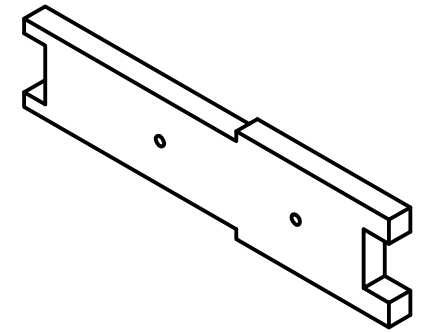

PROJECT BEE HIVE	CREATED BY A. PARDO	APPROVED BY		
PART NAME SHALLOW SUPER FRAME	PART CODE 7	DOCUMENT TYPE ASSEMBLY	MATERIAL WOOD	
 OPEN SOURCE ECOLOGY GERMANY	LICENSE 	FILE NAME SHALLOW SUPER FRAME.iam	VERSION 1.0	QUANTITY 1
		SCALE 1 / 3	SHEET 27/28	DATE 25/9/2020



PROJECT BEE HIVE	CREATED BY A. PARDO	APPROVED BY		
PART NAME SHALLOW SUPER FRAME A	PART CODE 7.1	DOCUMENT TYPE PART	MATERIAL WOOD	
	LICENSE 	FILE NAME SHALLOW SUPER FRAME A.ipt	VERSION 1.0	QUANTITY 1
		SCALE 1 : 1	SHEET 28/28	DATE 25/9/2020