

Hinweis: Alle einheiten in mm.

PROJEKT	ERSTELLT VON	GENEHMIGT VON	DATE	VERSION
DIY-Verbundmikroskop	E. Ceballos	A. Morillo	11/06/2021	1.0
TEIL-NAME	DATEI-NAME			TEIL-CODE
3d-Ansichten	DIY compound microscope.iam			A1
ENTWICKELT VON	UMGESTALTET VON	DOK. TYP	WERKSTOFF	MENGE
		Assembly		1
AMERICAN PEACE CORPS	OHO e.V.	LIZENZ	SCALE	SEITE
		CC-BY-SA 4.0	1:4	1 / 12

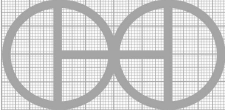
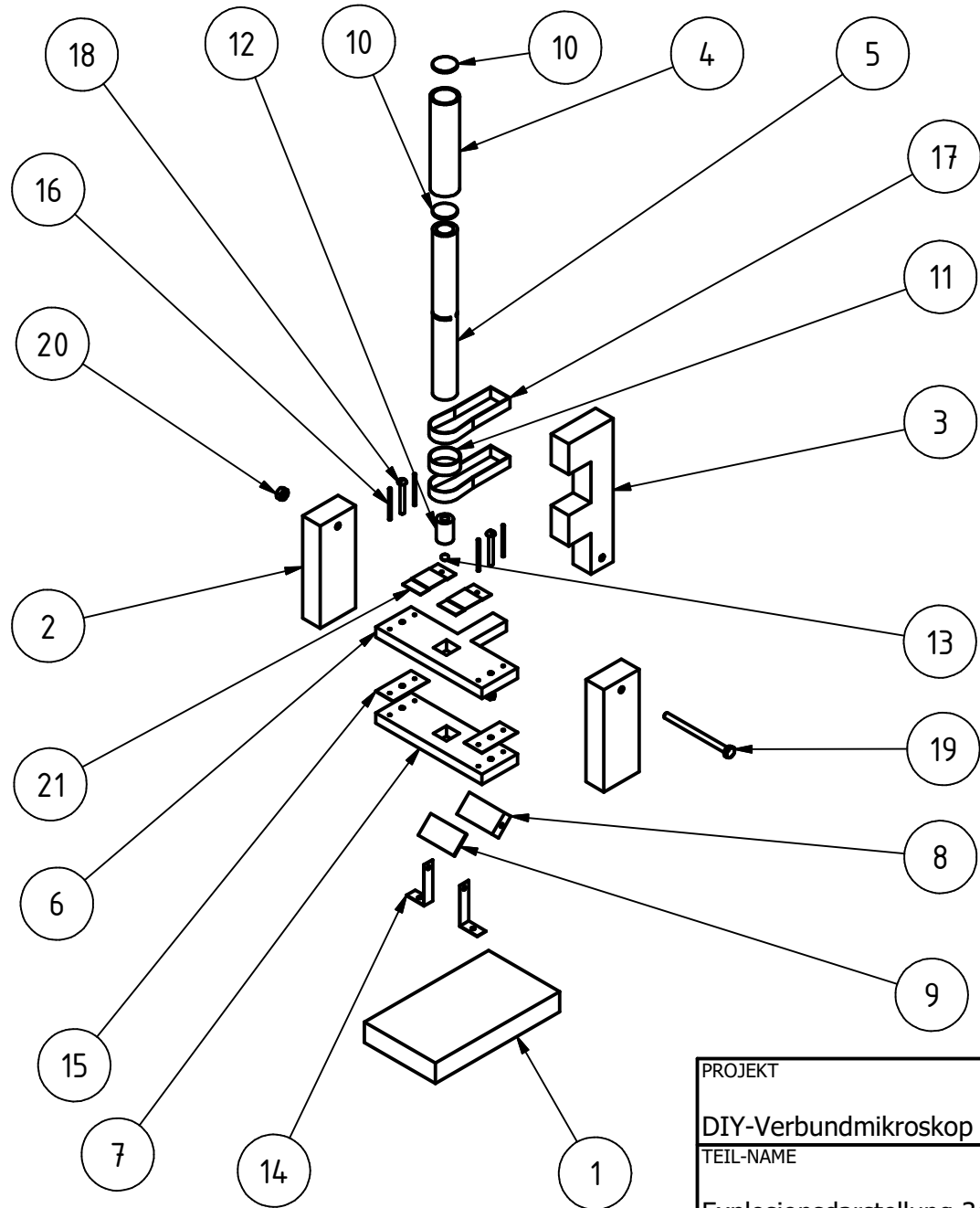
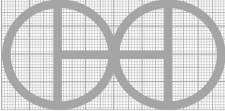

Hinweis: Alle einheiten in mm.

PROJEKT	ERSTELLT VON	GENEHMIGT VON	DATE	VERSION
DIY-Verbundmikroskop	E. Ceballos	A. Morillo	11/06/2021	1.0
TEIL-NAME	DATEI-NAME			TEIL-CODE
Explosionsdarstellung 3d	DIY compound microscope.ipn			A2
ENTWICKELT VON	UMGESTALTET VON	DOK. TYP	WERKSTOFF	MENGE
		Assembly		1
AMERICAN PEACE CORPS	OHO e.V.	LIZENZ	SCALE	SEITE
		CC-BY-SA 4.0	1:7	2 /12

Parts list

POS	QTY	TEIL NAME	DATEI-NAME	TEIL-TYP	SPEZIFIKATIONEN	SEITE
A1	1	3d-Ansichten	DIY compound microscope.iam			1
A2	1	Explosionsdarstellung 3d	DIY compound microscope.ipn			2
B1	1	Teileliste	part list.csv			3
C1	1	Technische Hinweise				4
1	1	Grundplatte	base board.ipt	Production	Getrocknetes Holz	5
2	2	Vertikale Stütze	vertical support.ipt	Production	Getrocknetes Holz	6
3	1	Zylinderhalterung	cylinder support.ipt	Production	Getrocknetes Holz	7
4	1	Karton-Zylinder	cardboard cylinder.ipt	Production	Karton	8
5	1	PVC-Zylinder	PVC cylinder.ipt	Production	PVC-Kunststoff	9
6	1	Plattform	platform.ipt	Production	Getrocknetes Holz	10
7	1	Plattform B	platform B.ipt	Production	Getrocknetes Holz	11
8	1	Spiegelhalterung	mirror support.ipt	Production	Getrocknetes Holz	12
9	1	Spiegel	mirror.ipt	Buy	Spiegel, 25,4 mm x 50,8 mm	
10	2	Okular	lens.ipt	Buy	Okularlinse 25,4 mm	
11	1	Isolierband	insulating tape B.ipt	Buy	Isolierband	
12	1	Kork	cork.ipt	Buy	Kork 25,4 mm	
13	1	Glühbirne	bulb.ipt	Buy	Glühbirne 8-10 mm	
14	2	Umreifungsband	strapping.ipt	Buy	Stahl, ASTM 1045 / DIN C45, 25,4 mm	
15	2	Umreifungsband B	strapping B.ipt	Buy	Stahl, ASTM 1045 / DIN C45, 25,4 mm	
16	10	Nagel 1 1/2"	1_2 nail.ipt	Buy	Stahl, ASTM F-1667	
17	2	Isolierband B	insulating tape B.ipt	Buy	Isolierband	
18	2	Schraube ANSI B18.6.3	screws.ipt	Standard	ANSI B18.6.3 - 10 - 24 x 1 1/2 SR HMS	
19	1	Schraube AS 2465	screw B.ipt	Standard	AS 2465 - 1/4 UNC	
20	1	Mutter B	nut B.ipt	Standard	AS 2465 - 1/4 UNC	
21	2	Umreifungsband C	strapping C.ipt	Buy	Stahl, ASTM 1045 / DIN C45, 25,4 mm	
22	2	Mutter	nut.ipt	Standard	UNI 5590 - A M5	

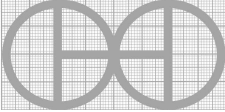
PROJEKT	ERSTELLT VON	GENEHMIGT VON	DATE	VERSION
DIY-Verbundmikroskop	E. Ceballos	A. Morillo	11/06/2021	1.0
TEIL-NAME	DATEI-NAME	TEIL-CODE		
Teileliste	part list.csv	B1		
ENTWICKELT VON	UMGESTALTET VON	DOK. TYP	WERKSTOFF	MENGE
		Parts list		
AMERICAN PEACE CORPS	OHO e.V.	LIZENZ	SCALE	SEITE
		CC-BY-SA 4.0		3 / 12

TECHNICAL NOTES

ANMERKUNGEN	INHALT
ALLGEMEINE ANMERKUNGEN	
Abstand zwischen der Objektivlinse	<p>Der Abstand zwischen der Objektivlinse und der ersten Linse des Okulars ist ein fester und unveränderlicher Abstand, dessen Länge durch die folgende Formel ermittelt werden kann:</p> $D = S + F$ <p>Dabei ist S definiert durch:</p> $1/S = -1/(f+1f) + 1/f \quad \text{oder} \quad S = 11 f$ <p>wobei f die Brennweite der Objektivlinse und F die Brennweite der ersten Linse des Okulars ist.</p>

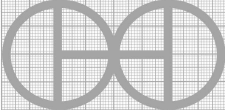
PROJEKT	ERSTELLT VON	GENEHMIGT VON	DATE	VERSION
DIY-Verbundmikroskop	E. Ceballos	A. Morillo	11/06/2021	1.0
TEIL-NAME	DATEI-NAME			TEIL-CODE
Technische Hinweise				C1
ENTWICKELT VON	UMGESTALTET VON	DOK. TYP	WERKSTOFF	MENGE
		Technical notes		
AMERICAN PEACE CORPS	OHO e.V.	LIZENZ	SCALE	SEITE
		CC-BY-SA 4.0		4 /12

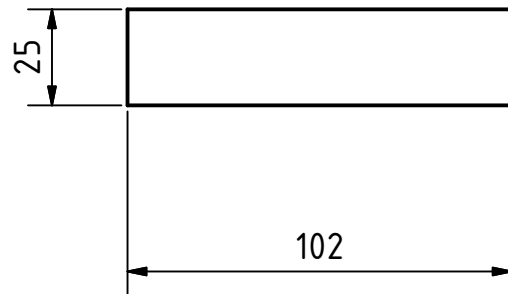
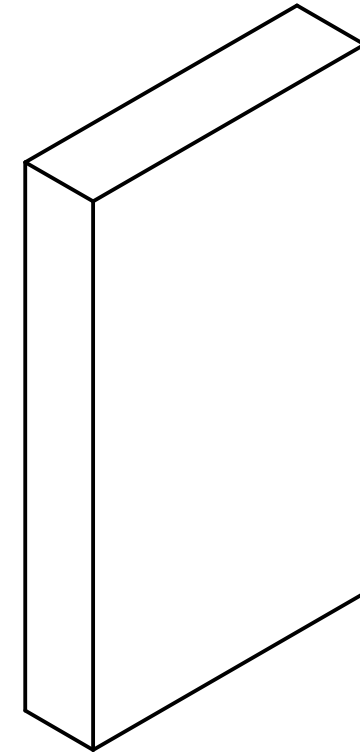
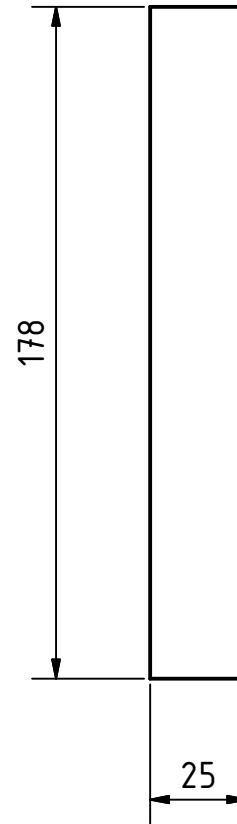
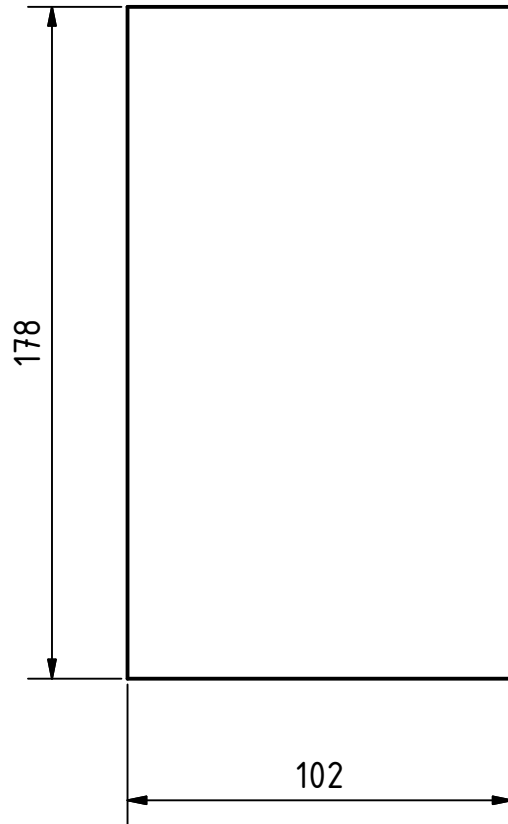

Hinweis: Alle einheiten in mm.

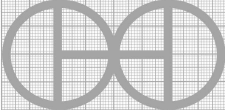
PROJEKT	ERSTELLT VON	GENEHMIGT VON	DATE	VERSION
DIY-Verbundmikroskop	E. Ceballos	A. Morillo	11/06/2021	1.0
TEIL-NAME	DATEI-NAME			TEIL-CODE
Grundplatte	base board.ipt			1.0
ENTWICKELT VON	UMGESTALTET VON	DOK. TYP	WERKSTOFF	MENGE
		Assembly	Getrocknetes Holz	1
AMERICAN PEACE CORPS	OHO e.V.	LIZENZ	SCALE	SEITE
		CC-BY-SA 4.0	1:2	5 /12

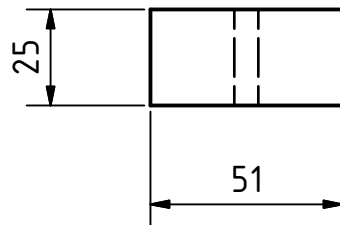
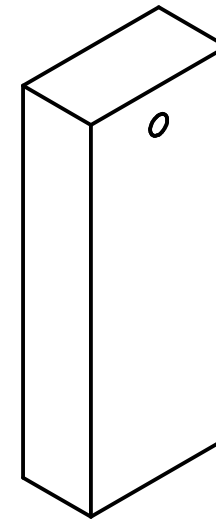
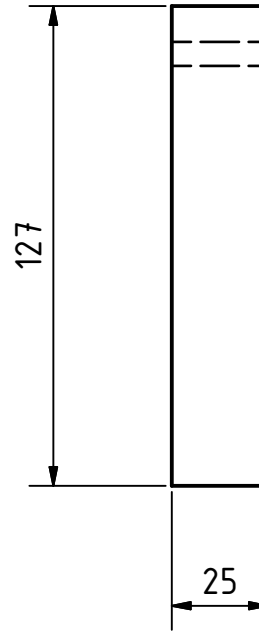
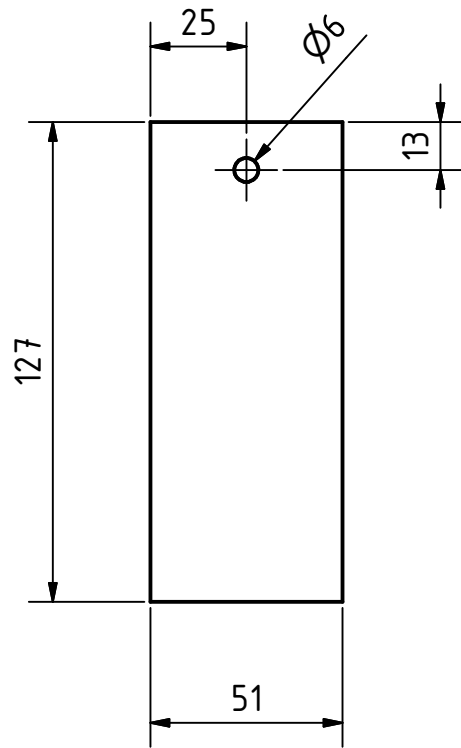

Hinweis: Alle einheiten in mm.

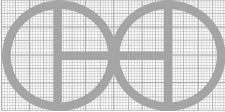
PROJEKT	ERSTELLT VON	GENEHMIGT VON	DATE	VERSION
DIY-Verbundmikroskop	E. Ceballos	A. Morillo	11/06/2021	1.0
TEIL-NAME	DATEI-NAME			TEIL-CODE
Vertikale Stütze	vertical support.ipt			2
ENTWICKELT VON	UMGESTALTET VON	DOK. TYP	WERKSTOFF	MENGE
		PART	Getrocknetes Holz	2
AMERICAN PEACE CORPS	OHO e.V.	LIZENZ	SCALE	SEITE
		CC-BY-SA 4.0	1:2	6 /12

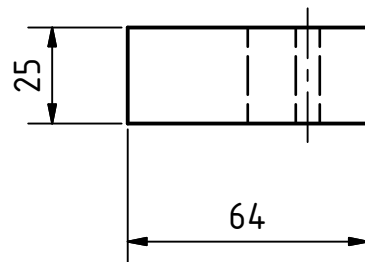
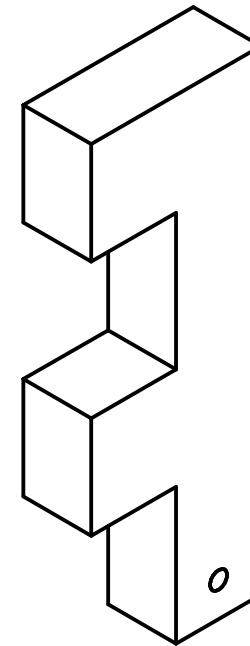
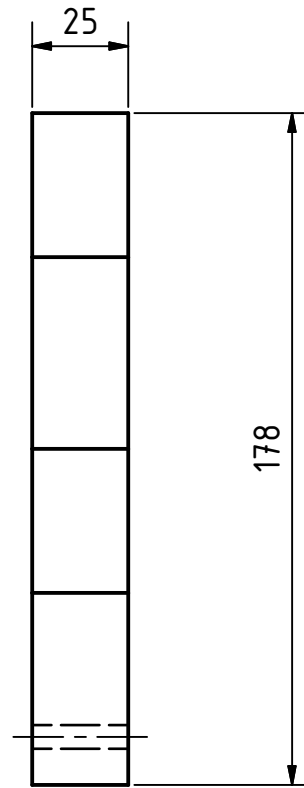
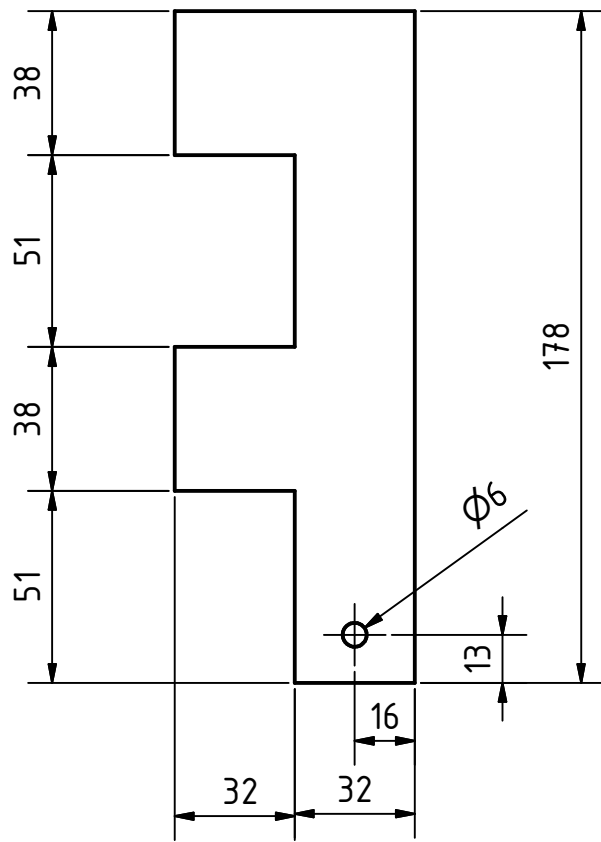

Hinweis: Alle einheiten in mm.

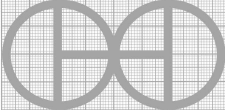
PROJEKT	ERSTELLT VON	GENEHMIGT VON	DATE	VERSION
DIY-Verbundmikroskop	E. Ceballos	A. Morillo	11/06/2021	1.0
TEIL-NAME	DATEI-NAME			TEIL-CODE
Zylinderhalterung	cylinder support.ipt			3
ENTWICKELT VON	UMGESTALTET VON	DOK. TYP	WERKSTOFF	MENGE
		PART	Getrocknetes Holz	1
AMERICAN PEACE CORPS	OHO e.V.	LIZENZ	SCALE	SEITE
		CC-BY-SA 4.0	1:2	7 /12

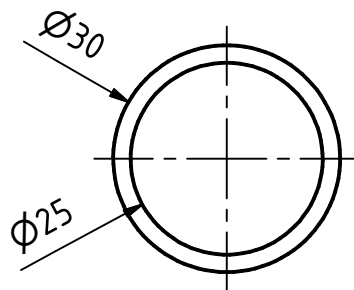
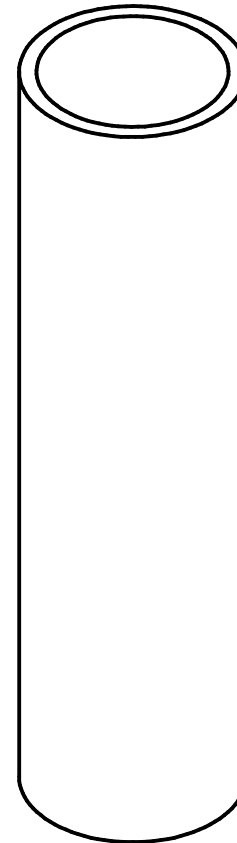
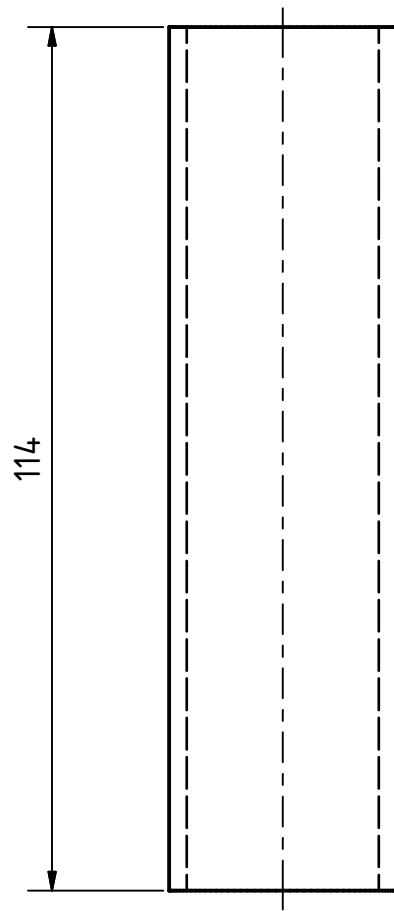

Hinweis: Alle einheiten in mm.

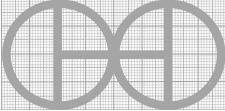
PROJEKT	ERSTELLT VON	GENEHMIGT VON	DATE	VERSION
DIY-Verbundmikroskop	E. Ceballos	A. Morillo	11/06/2021	1.0
TEIL-NAME	DATEI-NAME			TEIL-CODE
Karton-Zylinder	cardboard cylinder.ipt			4
ENTWICKELT VON	UMGESTALTET VON	DOK. TYP	WERKSTOFF	MENGE
		PART	Karton	1
AMERICAN PEACE CORPS	OHO e.V.	LIZENZ	SCALE	SEITE
		CC-BY-SA 4.0	1:1	8 /12

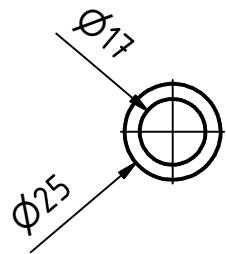
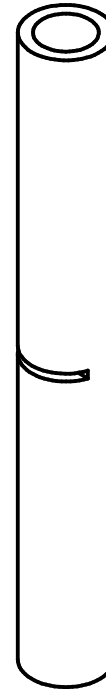
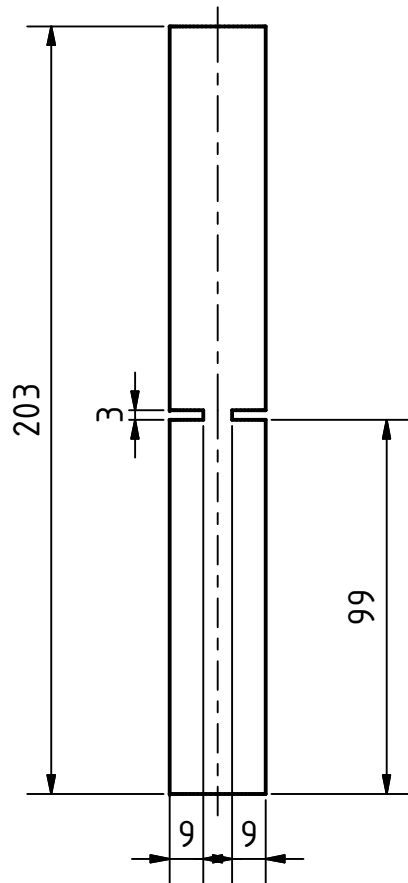

Hinweis: Alle einheiten in mm.

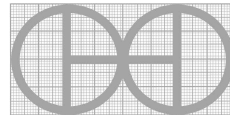
PROJEKT	ERSTELLT VON	GENEHMIGT VON	DATE	VERSION
DIY-Verbundmikroskop	E. Ceballos	A. Morillo	11/06/2021	1.0
TEIL-NAME	DATEI-NAME			TEIL-CODE
PVC-Zylinder	PVC cylinder.ipt			5
ENTWICKELT VON	UMGESTALTET VON	DOK. TYP	WERKSTOFF	MENGE
		PART	PVC-Kunststoff	1
AMERICAN PEACE CORPS	OHO e.V.	LIZENZ	SCALE	SEITE
		CC-BY-SA 4.0	1:2	9 /12

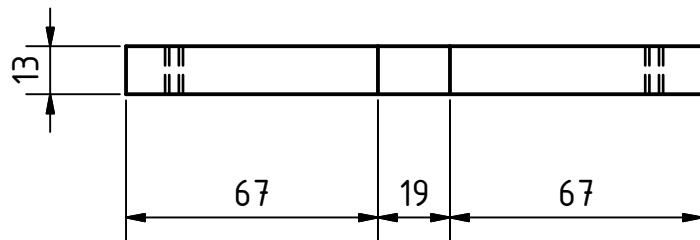
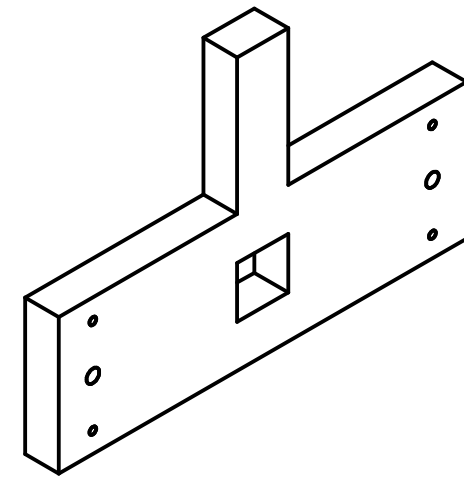
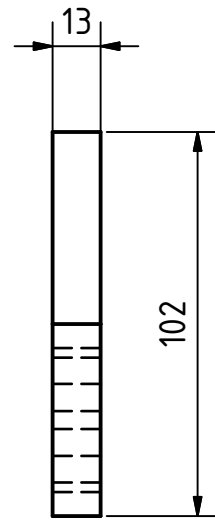
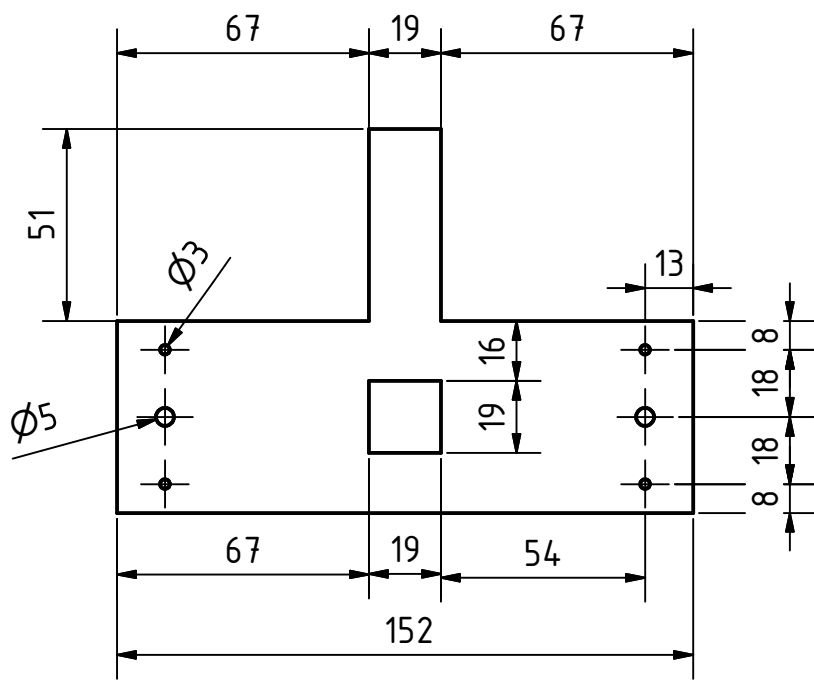

Hinweis: Alle einheiten in mm.

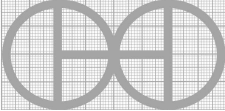
PROJEKT	ERSTELLT VON	GENEHMIGT VON	DATE	VERSION
DIY-Verbundmikroskop	E. Ceballos	A. Morillo	11/06/2021	1.0
TEIL-NAME	DATEI-NAME			TEIL-CODE
Plattform	platform.ipt			6
ENTWICKELT VON	UMGESTALTET VON	DOK. TYP	WERKSTOFF	MENGE
		PART	Getrocknetes Holz	1
AMERICAN PEACE CORPS	OHO e.V.	LIZENZ	SCALE	SEITE
		CC-BY-SA 4.0	1:2	10 /12

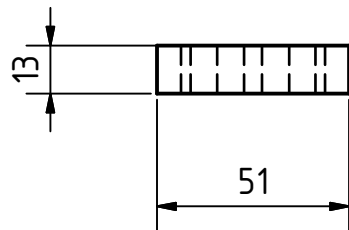
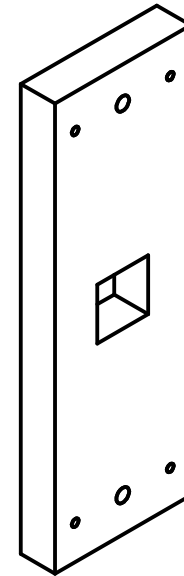
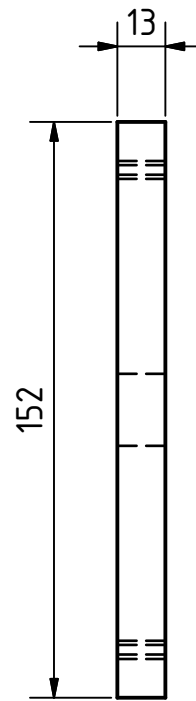
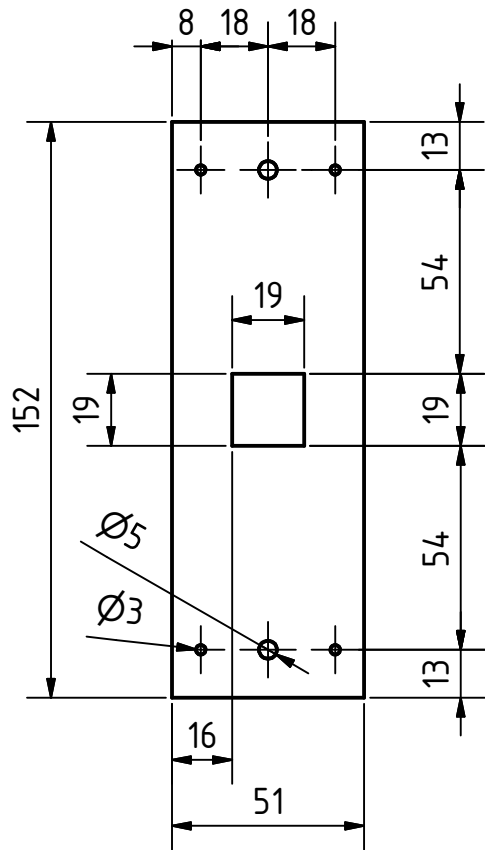

Hinweis: Alle einheiten in mm.

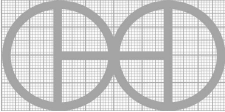
PROJEKT	ERSTELLT VON	GENEHMIGT VON	DATE	VERSION
DIY-Verbundmikroskop	E. Ceballos	A. Morillo	11/06/2021	1.0
TEIL-NAME	DATEI-NAME			TEIL-CODE
Plattform B	platform B.ipt			7
ENTWICKELT VON	UMGESTALTET VON	DOK. TYP	WERKSTOFF	MENGE
		PART	Getrocknetes Holz	1
AMERICAN PEACE CORPS	OHO e.V.	LIZENZ	SCALE	SEITE
		CC-BY-SA 4.0	1:2	11 /12

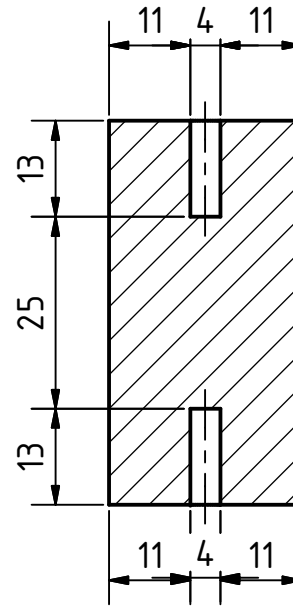
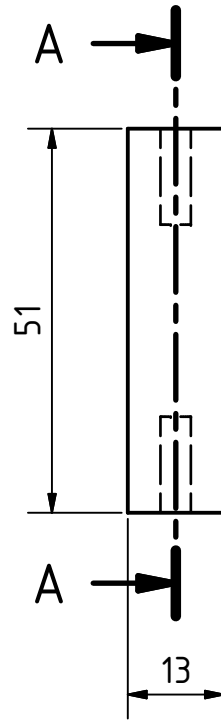
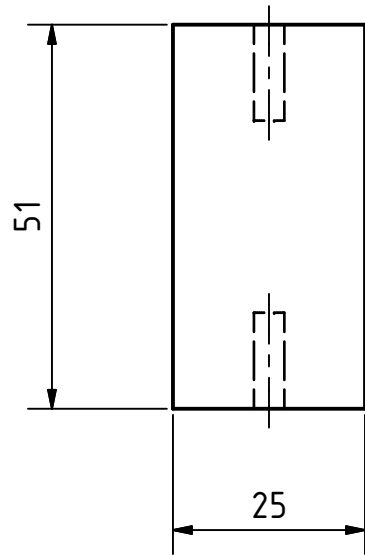

A-A (1 : 1)

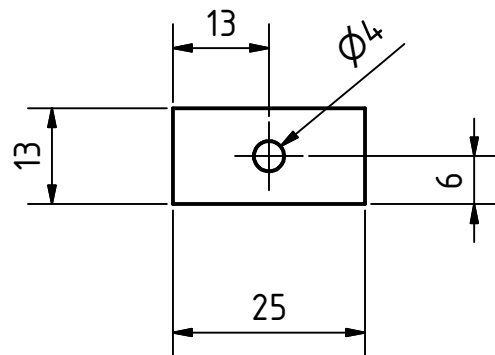
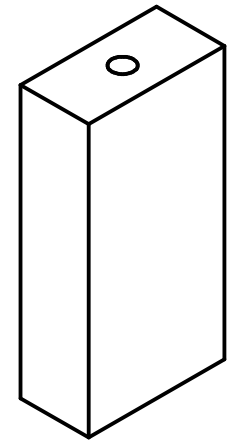

Hinweis: Alle einheiten in mm.

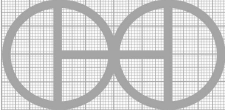
PROJEKT	ERSTELLT VON	GENEHMIGT VON	DATE	VERSION
DIY-Verbundmikroskop	E. Ceballos	A. Morillo	11/06/2021	1.0
TEIL-NAME	DATEI-NAME			TEIL-CODE
Spiegelhalterung	mirror support.ipt			8
ENTWICKELT VON	UMGESTALTET VON	DOK. TYP	WERKSTOFF	MENGE
		PART	Getrocknetes Holz	1
AMERICAN PEACE CORPS	OHO e.V.	LIZENZ	SCALE	SEITE
		CC-BY-SA 4.0	1:1	12 /12