

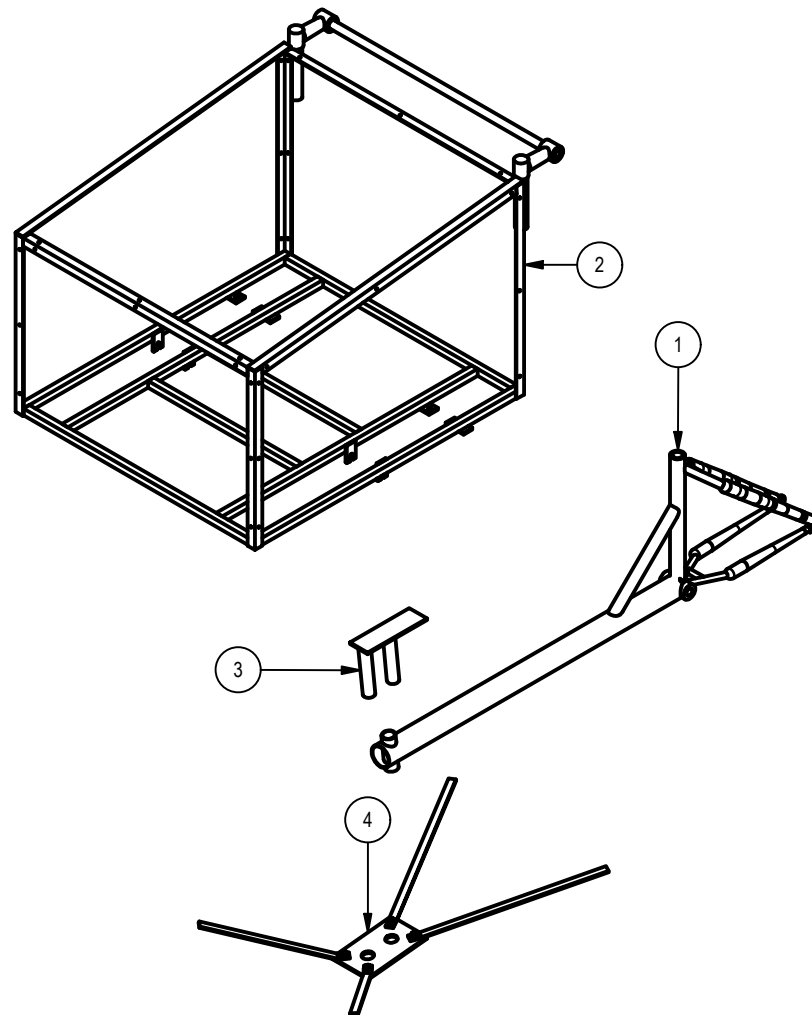



PROJECT TRICYCLE CARGO BIKE		CREATED BY A. PARDO		APPROVED BY D. Jaeger	
PART NAME tricycle cargo bike B		PART CODE A1		DOCUMENT TYPE ASSEMBLY	
 Open Source Ecology e.V. Knobelsdorffstr. 22 14059 Berlin www.ose-germany.de +49 (0) 30 / 92282426		LICENSE CERN-OHL		FILE NAME tricycle cargo bike B.iam	
		SCALE 1 / 15		MATERIAL	
		VERSION 1.0		QUANTITY	
		SHEET 1		DATE 12/1/2021	



PROJECT TRICYCLE CARGO BIKE		CREATED BY A. PARDO		APPROVED BY D. Jaeger	
PART NAME tricycle cargo bike B		PART CODE A2		DOCUMENT TYPE ASSEMBLY	
		LICENSE CERN-OHL		FILE NAME tricycle cargo bike B.iam	
		SCALE 1 / 18		VERSION 1.0	
		SHEET 2		QUANTITY	
		DATE 12/1/2021			

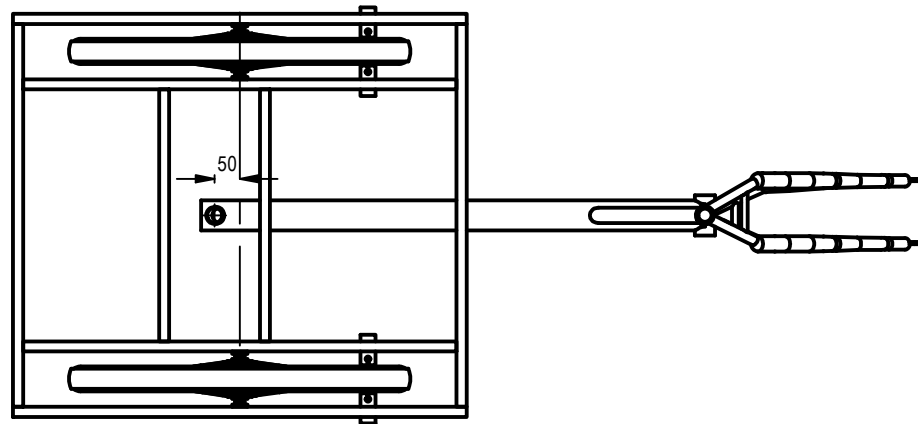
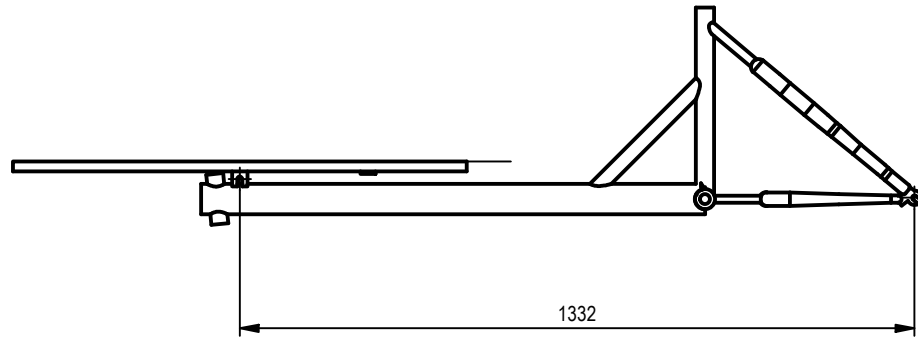

PROJECT TRICYCLE CARGO BIKE		CREATED BY A. PARDO		APPROVED BY D. Jaeger	
PART NAME tricycle cargo bike B		PART CODE A3		DOCUMENT TYPE ASSEMBLY	
 <p>Open Source Ecology e.V. Knobelsdorffstr. 22 14059 Berlin www.ose-germany.de +49 (0) 30 / 92282426</p>		LICENSE CERN-OHL		FILE NAME tricycle cargo bike B.iam	
		SCALE 1 / 15		VERSION 1.0	
		SHEET 3		QUANTITY DATE 12/1/2021	

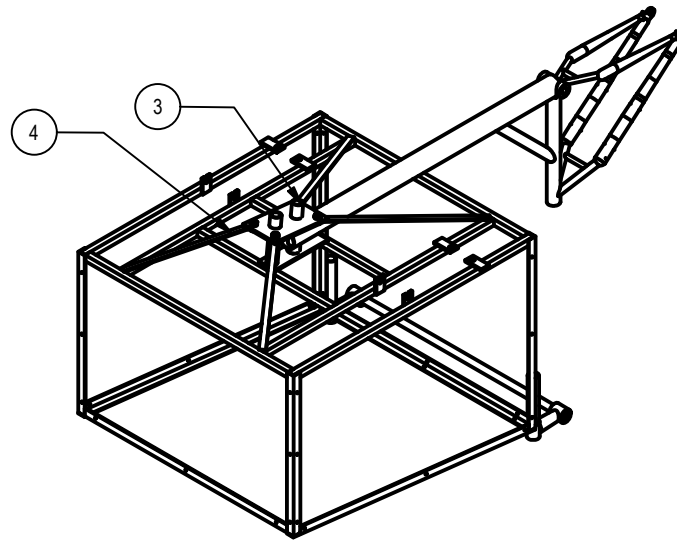
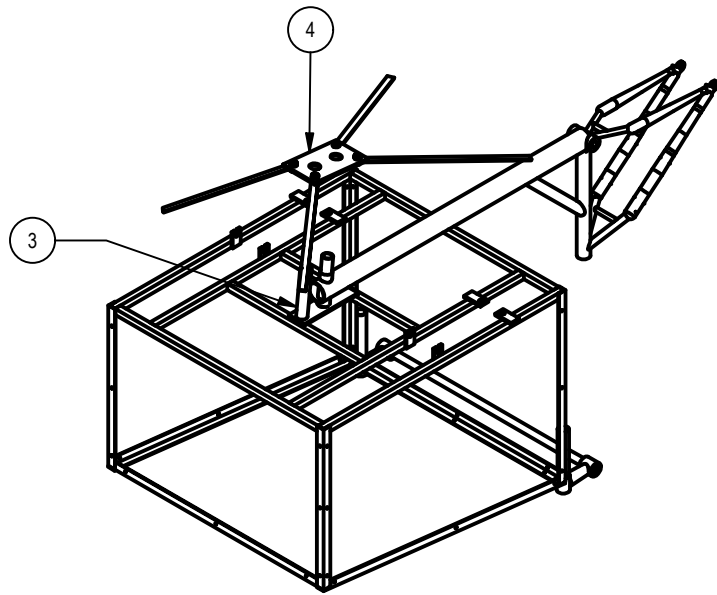

PROJECT TRICYCLE CARGO BIKE		CREATED BY A. PARDO		APPROVED BY D. Jaeger	
PART NAME tricycle cargo bike B		PART CODE A4		DOCUMENT TYPE ASSEMBLY	
 <p>Open Source Ecology e.V. Knobelsdorffstr. 22 14059 Berlin www.ose-germany.de +49 (0) 30 / 92282426</p> <p>OPEN SOURCE ECOLOGY GERMANY</p>		LICENSE CERN-OHL		FILE NAME tricycle cargo bike B.iam	
		SCALE 1 / 20		VERSION 1.0	
				SHEET 4	
				DATE 12/1/2021	

PARTS LIST							
POS.	POS. OLD	QTY	PART NUMBER	FILE NAME	PART TYPE	SPECIFICATION	SHEET
A1		1	tricycle cargo bike B	tricycle cargo bike B.iam	ASSEMBLY		1
A2		1	tricycle cargo bike B	tricycle cargo bike B.iam	ASSEMBLY		2
A3		1	tricycle cargo bike B	tricycle cargo bike B.iam	ASSEMBLY		3
A4		1	tricycle cargo bike B	tricycle cargo bike B.iam	ASSEMBLY		4
B1		1	parts-tricycle cargo bike B	parts-tricycle cargo bike B.iam	ASSEMBLY		5
1		1	Assembly1-tricycle cargo bike B	Assembly1-tricycle cargo bike B.iam	ASSEMBLY		6
1.1	1	1	wl_lacb_1.1_Down-tube	wl_lacb_1.1_Down-tube.ipt	Production	A36	7
1.2	2	1	wl_lacb_1.2_Head-tube	wl_lacb_1.2_Head-tube.ipt	Production	A36	8
1.3	3	1	wl_lacb_1.3_Angle-profile-box	wl_lacb_1.3_Old-frame-rear-part.ipt	Standard		
1.4	2	1	wl_lacb_1.4_Reinforcement-pipe	wl_lacb_1.4_Reinforcement-pipe.ipt	Standard		
2		1	Assembly2-tricycle cargo bike B	Assembly2-tricycle cargo bike B.iam	ASSEMBLY		
2.1		1	Assembly2-tricycle cargo bike B	Assembly2-tricycle cargo bike B.iam	ASSEMBLY		10
2.2	9	2	wl_lacb_2.2_Parts-box-bottom	wl_lacb_2.2_Parts-box-bottom.ipt	Production	A36	11
2.3	10	4	wl_lacb_2.3_Wheel-mount	wl_lacb_2.3_Wheel-mount.ipt	Production	A36	12
2.4	11	4	wl_lacb_2.4_Brake-holder	wl_lacb_2.4_Brake-holder.ipt	Production	A36	13
2.5	13	2	wl_lacb_2.5_Angle-profile-box	wl_lacb_2.5_Angle-profile-box.ipt	Production	A36	14
2.6	14	2	wl_lacb_2.6_Stem-mounting	wl_lacb_2.6_Stem-mounting.ipt	Standard		
2.7	15	1	wl_lacb_2.7_Steering-handle	wl_lacb_2.7_Steering-handle.ipt	Production	A36	15
2.8	16	2	wl_lacb_2.8_Wall-plate-holder	wl_lacb_2.8_Wall-plate-holder.ipt	Production	A36	16
2.9	9	2	wl_lacb_2.9_Parts-box-bottom	wl_lacb_2.9_Parts-box-bottom.ipt	Production	A36	17
2.10	9	2	wl_lacb_2.10_Parts-box-bottom	wl_lacb_2.10_Parts-box-bottom.ipt	Production	A36	18
2.11	9	2	wl_lacb_2.11_Parts-box-bottom	wl_lacb_2.11_Parts-box-bottom.ipt	Production	A36	19
2.12	13	2	wl_lacb_2.12_Angle-profile-box	wl_lacb_2.12_Angle-profile-box.ipt	Production	A36	20
2.13	13	2	wl_lacb_2.13_Angle-profile-box	wl_lacb_2.13_Angle-profile-box.ipt	Production	A36	21
2.14	13	2	wl_lacb_2.14_Angle-profile-box	wl_lacb_2.14_Angle-profile-box.ipt	Production	A36	22
3		1	Assembly3-tricycle cargo bike B	Assembly3-tricycle cargo bike B.iam	ASSEMBLY		23
3.1	5	1	wl_lacb_3.1_Head tube-plate	wl_lacb_3.1_Head tube-plate.ipt	Production	A36	24
3.2	3	1	wl_lacb_3.2_Handlebar	wl_lacb_3.2_Handlebar.ipt	Standard		
3.3	4	1	wl_lacb_3.3_Security tube	wl_lacb_3.3_Security tube.ipt	Standard		
4		1	Assembly4-tricycle cargo bike B	Assembly4-tricycle cargo bike B.iam	ASSEMBLY		25
4.1	8	1	wl_lacb_4.1_Security-plate	wl_lacb_4.1_Security-plate.ipt	Production	A36	26
4.2	12	2	wl_lacb_4.2_Strut	wl_lacb_4.2_Strut.ipt	Production	A36	27
4.3	12	2	wl_lacb_4.3_Strut	wl_lacb_4.3_Strut.ipt	Production	A36	28
4.4		4	ASME B18.21.2M - 10, LWSHHSLW	ASME B18.21.2M - 10B.ipt	Standard	ASME B18.21.2M - 10B	
4.5		4	ANSI B18.2.4.5M - M10 x 1.5	ANSI B18.2.4.5M - M10 x 1.5 - 16.ipt	Standard	ANSI B18.2.4.5M - M10 x 1.5 - 16	
4.6		4	ANSI B18.2.3.5M - M10 x 1,5 x 20	ANSI B18.2.3.5M - M10 x 1,5 x 20.ipt	Standard	ANSI B18.2.3.5M - M10 x 1,5 x 20	

PROJECT TRICYCLE CARGO BIKE		CREATED BY A. PARDO	APPROVED BY D. Jaeger			
PART NAME parts-tricycle cargo bike B		PART CODE B1	DOCUMENT TYPE PART LIST		MATERIAL	
 <p>Open Source Ecology e.V Knobelsdorffstr. 22 14059 Berlin www.ose-germany.de +49 (0) 30 / 92282426</p>	LICENSE CERN-OHL		FILE NAME parts-tricycle cargo bike B.iam		VERSION 1.0	QUANTITY
			SCALE 1 / 50	SHEET 5	DATE 12/1/2021	

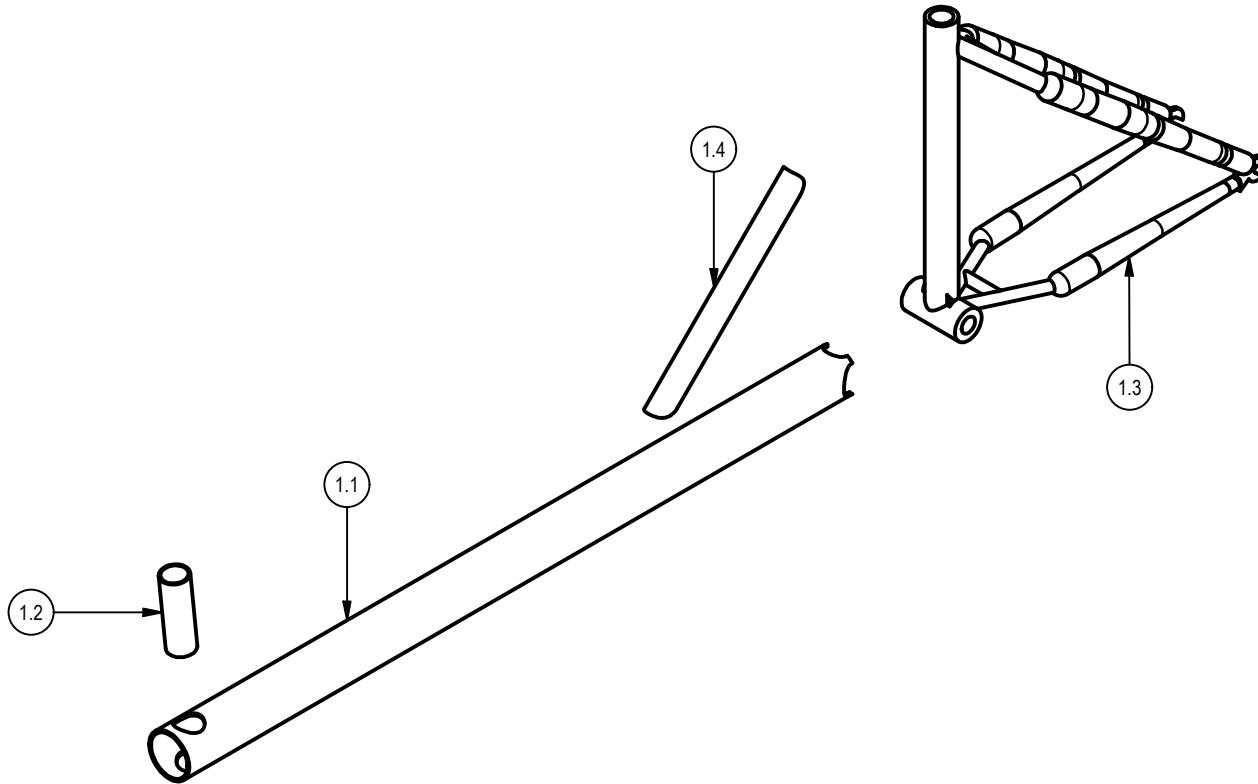

PROJECT TRICYCLE CARGO BIKE		CREATED BY A. PARDO		APPROVED BY D. Jaeger	
PART NAME Assembly1-tricycle cargo bike B		PART CODE 1.01		DOCUMENT TYPE	
 <p>Open Source Ecology e.V Knobelsdorffstr. 22 14059 Berlin www.ose-germany.de +49 (0) 30 / 92282426</p>		LICENSE CERN-OHL		FILE NAME Assembly1-tricycle cargo bike B.iam	
		SCALE 1 / 8		VERSION 1.0	
		SHEET 4		QUANTITY	
		DATE 12/1/2021			

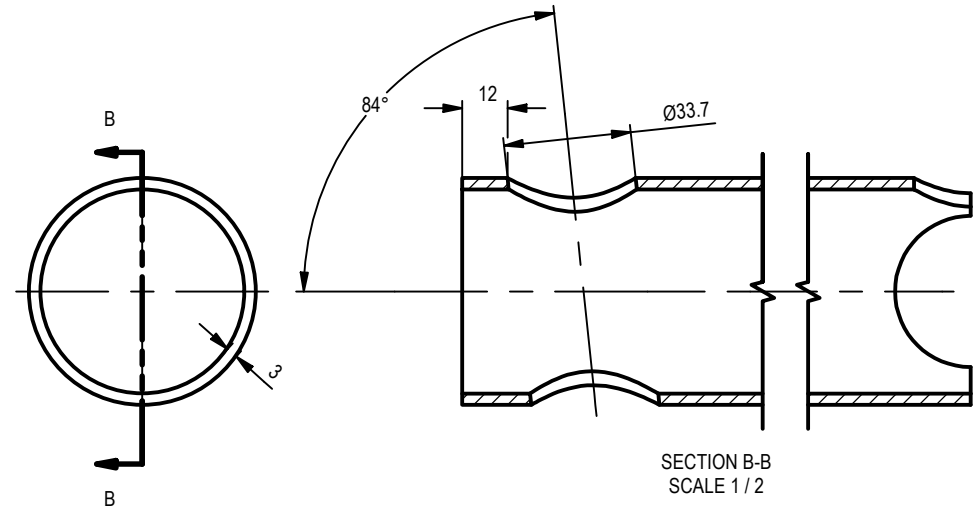
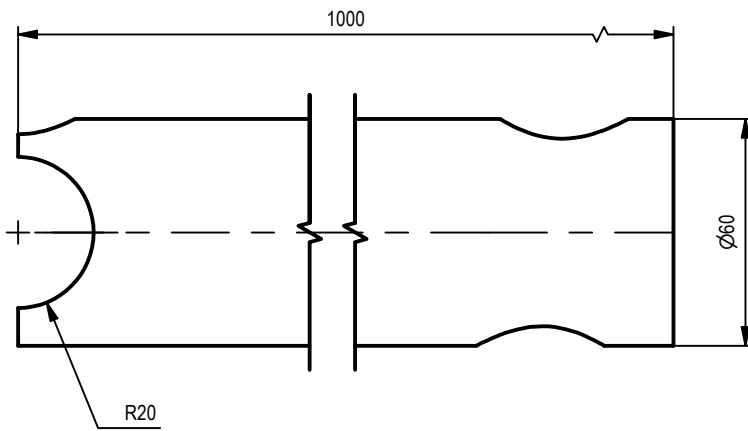
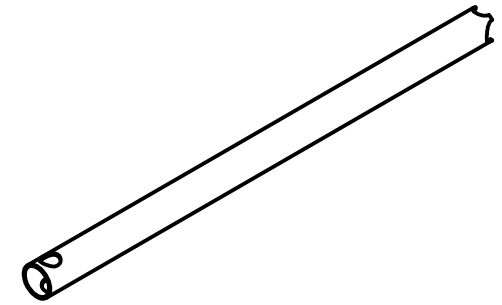
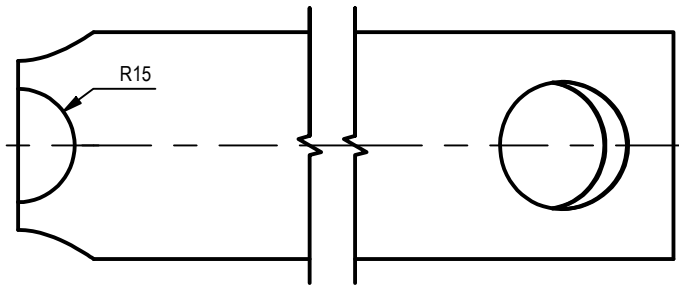

PROJECT TRICYCLE CARGO BIKE		CREATED BY A. PARDO		APPROVED BY D. Jaeger	
PART NAME wl_lacb_1.1_Down-tube		PART CODE 1.1		DOCUMENT TYPE Production	
 <p>Open Source Ecology e.V. Knobelsdorffstr. 22 14059 Berlin www.ose-germany.de +49 (0) 30 / 92282426</p>		LICENSE CERN-OHL		MATERIAL A36	
		FILE NAME wl_lacb_1.1_Down-tube.ipt		VERSION 1.0	
		SCALE 1/2		SHEET 7	
				DATE 11/1/2021	

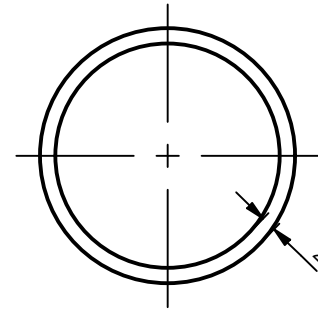
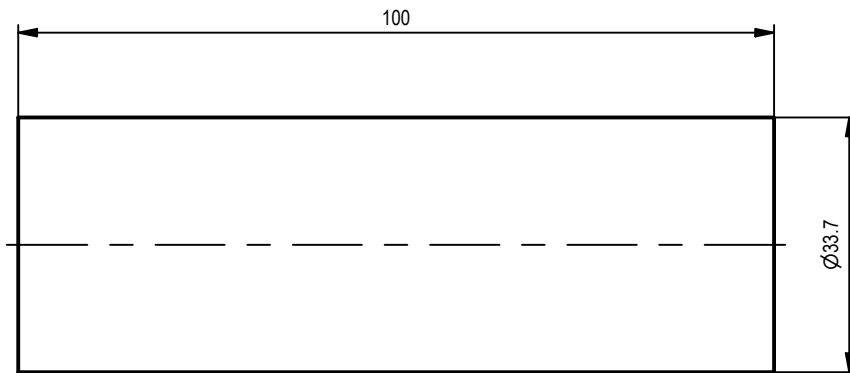
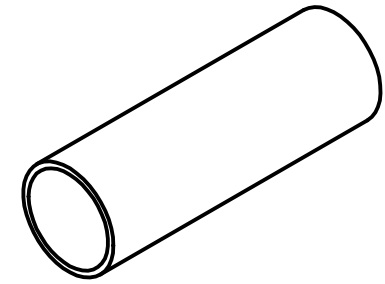

PROJECT TRICYCLE CARGO BIKE		CREATED BY A. PARDO		APPROVED BY D. Jaeger	
PART NAME wl_lacb_1.2_Head-tube		PART CODE 1.2		DOCUMENT TYPE Production	
 Open Source Ecology e.V. Knobelsdorffstr. 22 14059 Berlin www.ose-germany.de +49 (0) 30 / 92282426		LICENSE CERN-OHL		FILE NAME wl_lacb_1.2_Head-tube.ipt	
				SCALE 1 : 1	
		MATERIAL A36		VERSION 1.0	
		SHEET 8		QUANTITY 1	
				DATE 11/1/2021	

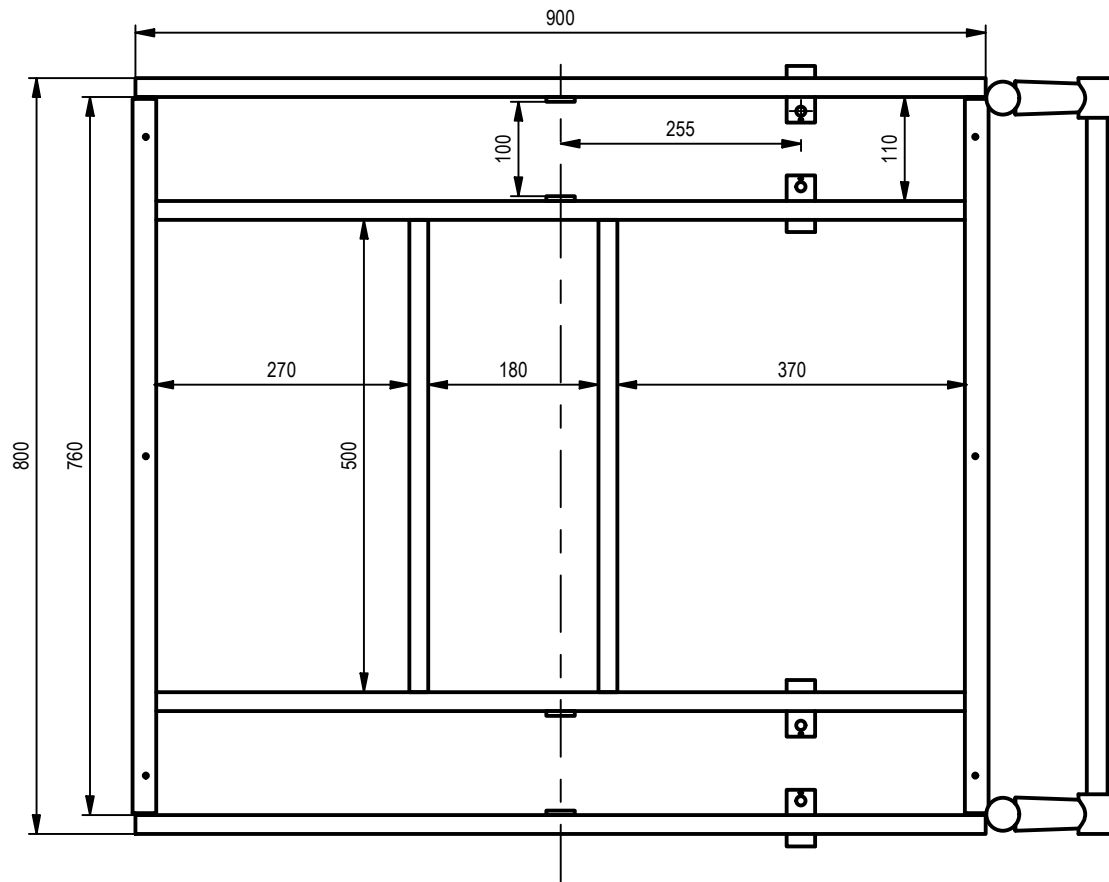

PROJECT	CREATED BY A. PARDO	APPROVED BY		
PART NAME	PART CODE	DOCUMENT TYPE	MATERIAL	
 Open Source Ecology e.V. Knobelsdorffstr. 22 14059 Berlin www.ose-germany.de +49 (0) 30 / 92282426	LICENSE CERN-OHL	FILE NAME Assembly2-tricycle cargo bike B.iam	VERSION	QUANTITY
		SCALE 1 / 8	SHEET 10	DATE

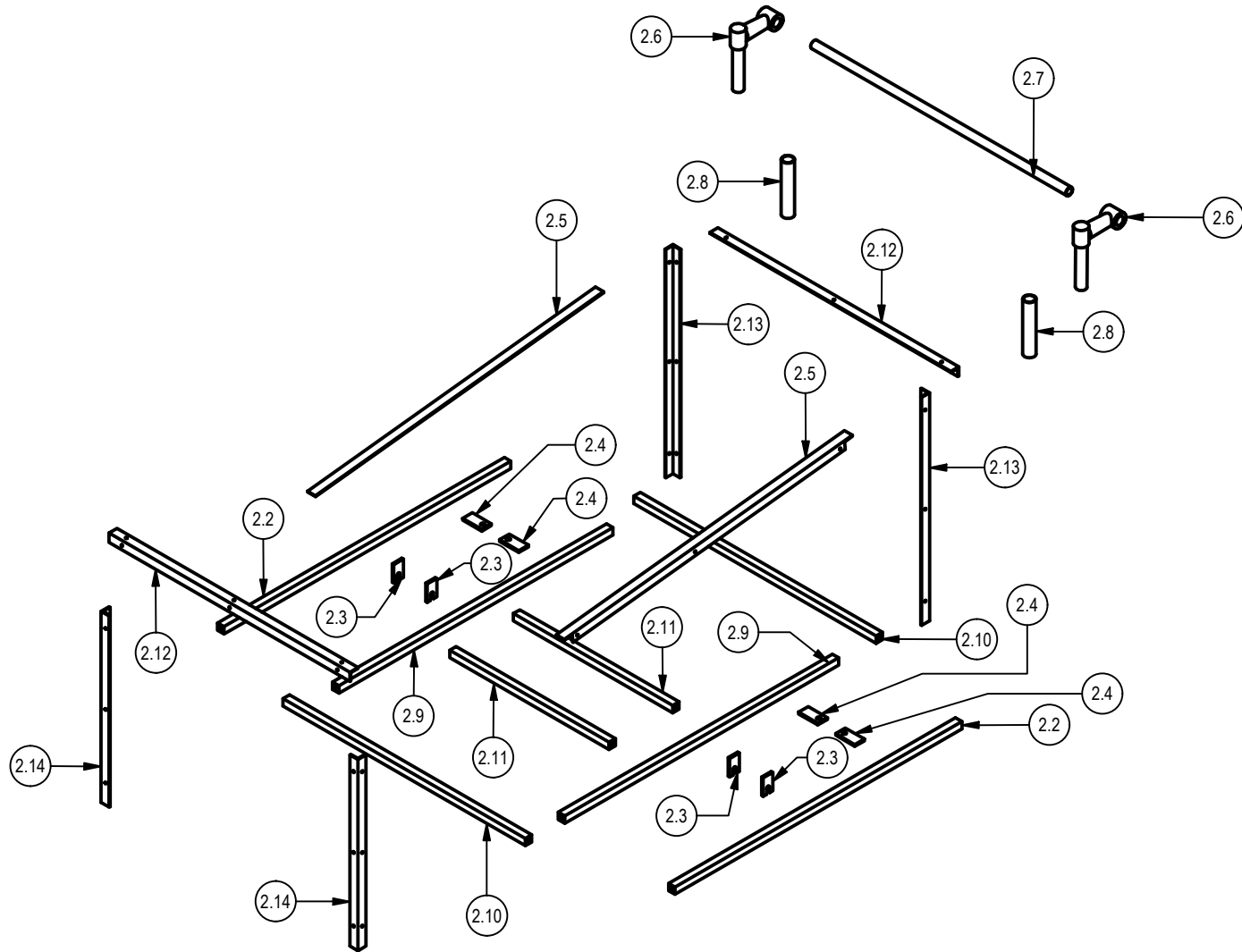

PROJECT TRICYCLE CARGO BIKE		CREATED BY A. PARDO		APPROVED BY D. Jaeger	
PART NAME Assembly2-tricycle cargo bike B		PART CODE 2		DOCUMENT TYPE ASSEMBLY	
 <p>Open Source Ecology e.V. Knobelsdorffstr. 22 14059 Berlin www.ose-germany.de +49 (0) 30 / 92282426</p>		LICENSE CERN-OHL		FILE NAME Assembly2-tricycle cargo bike B.iam	
		SCALE 1 / 15		VERSION 1.0	
		SHEET 9		QUANTITY DATE 12/1/2021	

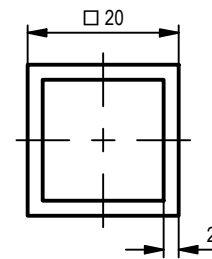
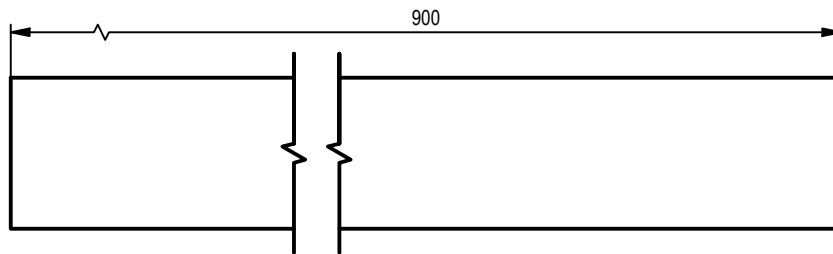
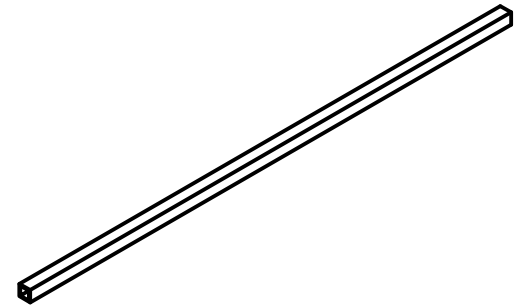

PROJECT TRICYCLE CARGO BIKE		CREATED BY A. PARDO		APPROVED BY D. Jaeger	
PART NAME wl_lacb_2.2_Parts-box-bottom		PART CODE 2.2		DOCUMENT TYPE Production	
 Open Source Ecology e.V. Knobelsdorffstr. 22 14059 Berlin www.ose-germany.de +49 (0) 30 / 92282426		LICENSE CERN-OHL		FILE NAME wl_lacb_2.2_Parts-box-bottom.ipt	
		SCALE 1 : 1		VERSION 1.0	
		SHEET 11		QUANTITY 1	
		DATE 12/1/2021			

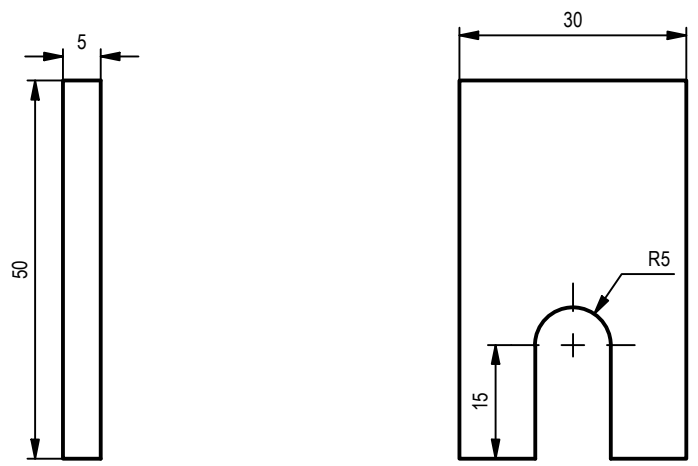
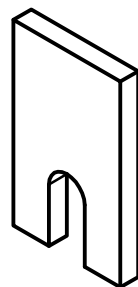

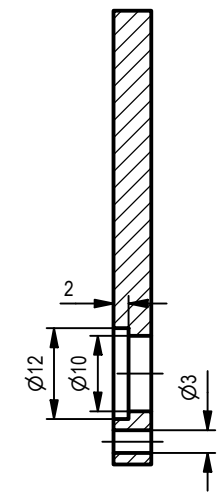
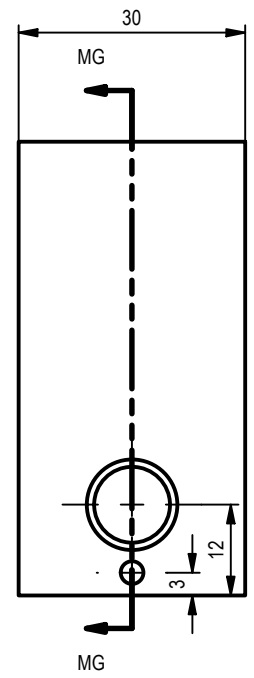
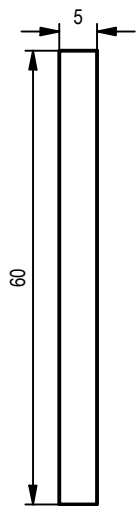
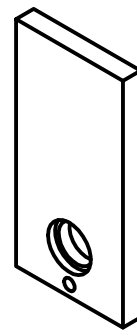

PROJECT TRICYCLE CARGO BIKE		CREATED BY A. PARDO		APPROVED BY D. Jaeger	
PART NAME wl_lacb_2.3_Wheel-mount		PART CODE 2.3		DOCUMENT TYPE Production	
 <p>Open Source Ecology e.V Knobelsdorffstr. 22 14059 Berlin www.ose-germany.de +49 (0) 30 / 92282426</p> <p>OPEN SOURCE ECOLOGY GERMANY</p>		LICENSE CERN-OHL		FILE NAME wl_lacb_2.3_Wheel-mount.ipt	
		SCALE 1 : 1		MATERIAL A36	
		VERSION 1.0		QUANTITY 1	
		SHEET 12		DATE 12/1/2021	



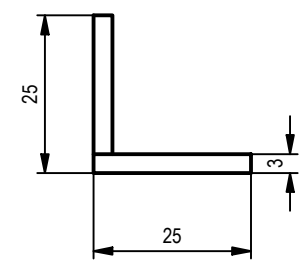
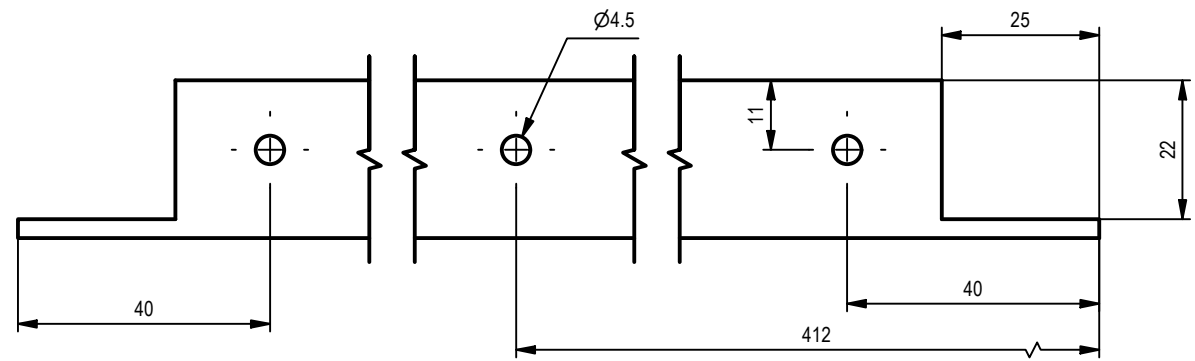
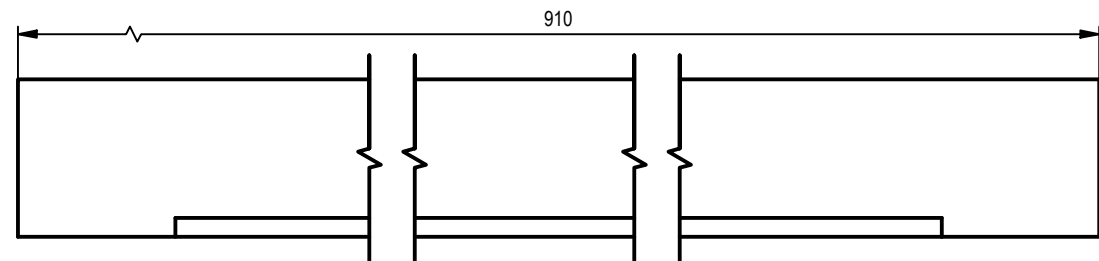
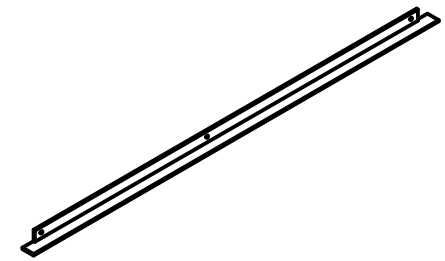

SECTION MG-MG
SCALE 1 : 1

PROJECT TRICYCLE CARGO BIKE		CREATED BY A. PARDO		APPROVED BY D. Jaeger	
PART NAME wl_lacb_2.4 Brake-holder		PART CODE 2.4		DOCUMENT TYPE Production	
 <p>Open Source Ecology e.V Knobelsdorffstr. 22 14059 Berlin www.ose-germany.de +49 (0) 30 / 92282426</p> <p>OPEN SOURCE ECOLOGY GERMANY</p>		LICENSE CERN-OHL		FILE NAME wl_lacb_2.4_Brake-holder.ipt	
		SCALE 1 : 1		MATERIAL A36	
		VERSION 1.0		QUANTITY 1	
		SHEET 13		DATE 12/1/2021	

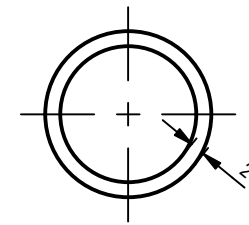
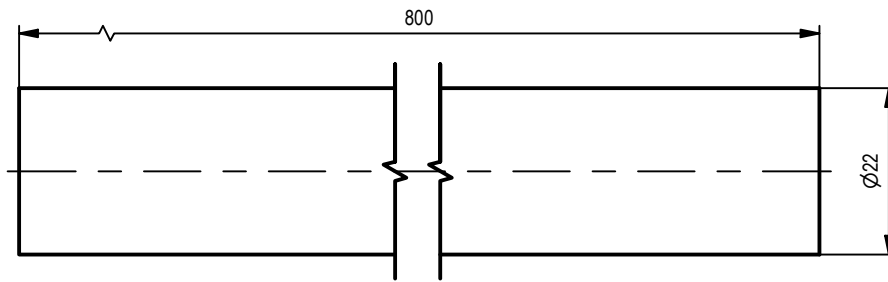
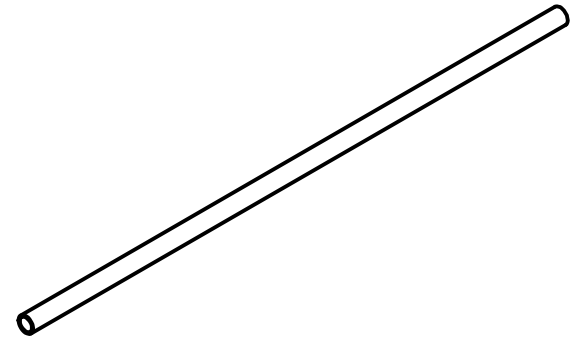

PROJECT TRICYCLE CARGO BIKE		CREATED BY A. PARDO		APPROVED BY D. Jaeger	
PART NAME wl_lacb_2.5_Angle-profile-box		PART CODE 2.5		DOCUMENT TYPE Production	
 Open Source Ecology e.V. Knobelsdorffstr. 22 14059 Berlin www.ose-germany.de +49 (0) 30 / 92282426		LICENSE CERN-OHL		FILE NAME wl_lacb_2.5_Angle-profile-box.ipt	
		SCALE 1 : 1.2		MATERIAL A36	
		VERSION 1.0		QUANTITY 1	
		SHEET 14		DATE 12/1/2021	



PROJECT TRICYCLE CARGO BIKE		CREATED BY A. PARDO		APPROVED BY D. Jaeger	
PART NAME wl_lacb_2.7_Steering-handle		PART CODE 2.7		DOCUMENT TYPE Production	
 Open Source Ecology e.V. Knobelsdorffstr. 22 14059 Berlin www.ose-germany.de +49 (0) 30 / 92282426		LICENSE CERN-OHL		MATERIAL A36	
		FILE NAME wl_lacb_2.7_Steering-handle.ipt		VERSION 1.0	
		SCALE 1 : 1		SHEET 15	
				DATE 12/1/2021	

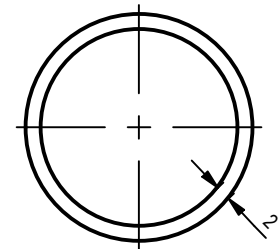
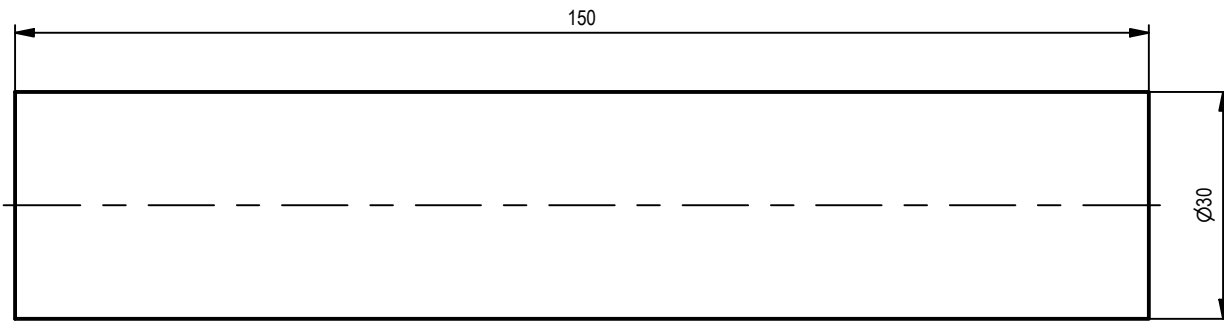
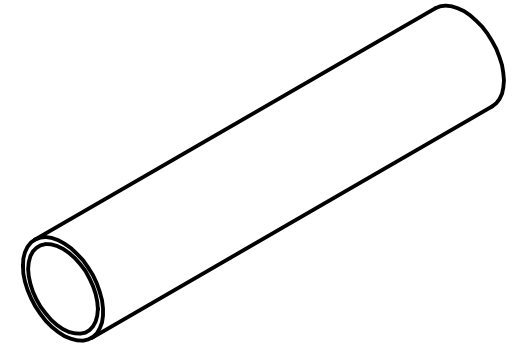

PROJECT TRICYCLE CARGO BIKE		CREATED BY A. PARDO		APPROVED BY D. Jaeger	
PART NAME wl_lacb_2.8_Wall-plate-holder		PART CODE 2.8		DOCUMENT TYPE Production	
 Open Source Ecology e.V. Knobelsdorffstr. 22 14059 Berlin www.ose-germany.de +49 (0) 30 / 92282426		LICENSE CERN-OHL		FILE NAME wl_lacb_2.8_Wall-plate-holder.ipt	
		SCALE 1 : 1		VERSION 1.0	
				SHEET 16	
				DATE 12/1/2021	

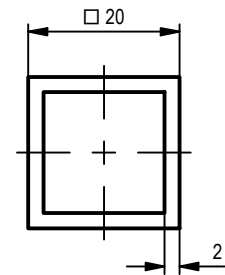
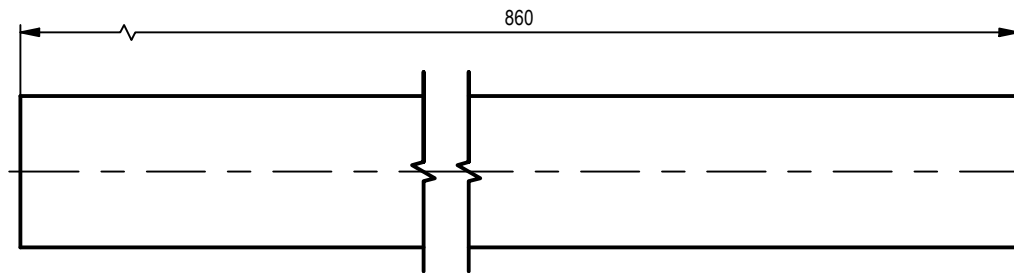
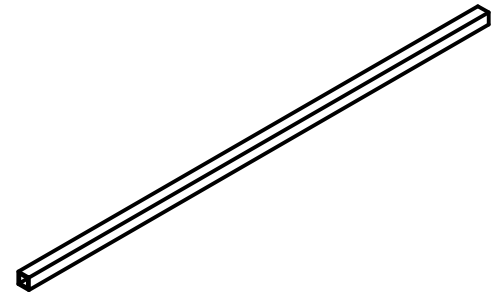

PROJECT TRICYCLE CARGO BIKE		CREATED BY A. PARDO		APPROVED BY D. Jaeger	
PART NAME wl_lacb_2.9_Parts-box-bottom		PART CODE 2.9		DOCUMENT TYPE Production	
 Open Source Ecology e.V. Knobelsdorffstr. 22 14059 Berlin www.ose-germany.de +49 (0) 30 / 92282426		LICENSE CERN-OHL		FILE NAME wl_lacb_2.9_Parts-box-bottom.ipt	
		SCALE 1 : 1		VERSION 1.0	
		SHEET 17		QUANTITY 1	
		DATE 12/1/2021			

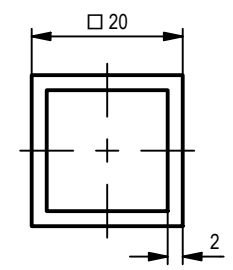
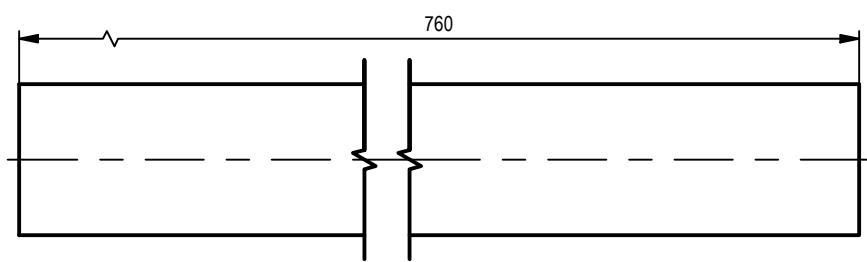
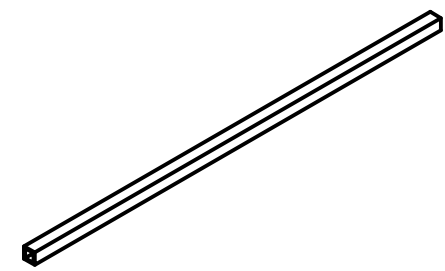

PROJECT TRICYCLE CARGO BIKE		CREATED BY A. PARDO		APPROVED BY D. Jaeger	
PART NAME wl_lacb_2.10_Parts-box-bottom		PART CODE 2.10		DOCUMENT TYPE Production	
 <p>Open Source Ecology e.V. Knobelsdorffstr. 22 14059 Berlin www.ose-germany.de +49 (0) 30 / 92282426</p>		LICENSE CERN-OHL		FILE NAME wl_lacb_2.10_Parts-box-bottom .ipt	
				SCALE 1 : 1	
		MATERIAL A36		VERSION 1.0	
		QUANTITY 1		DATE 12/1/2021	
		SHEET 18			

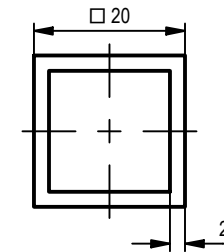
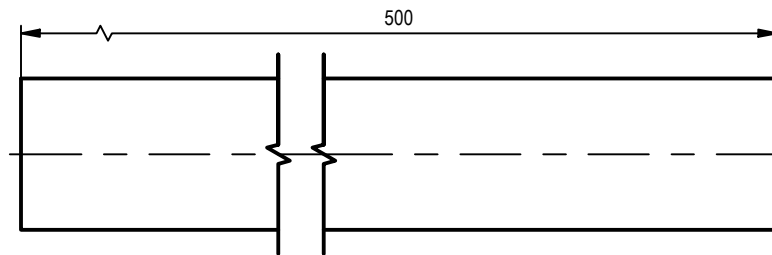
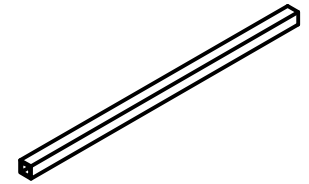

PROJECT TRICYCLE CARGO BIKE		CREATED BY A. PARDO		APPROVED BY D. Jaeger	
PART NAME wl_lacb_2.11_Parts-box-bottom		PART CODE 2.11		DOCUMENT TYPE Production	
 <p>Open Source Ecology e.V Knobelsdorffstr. 22 14059 Berlin www.ose-germany.de +49 (0) 30 / 92282426</p>		LICENSE CERN-OHL		MATERIAL A36	
		FILE NAME wl_lacb_2.11_Parts-box-bottom.ipt		VERSION 1.0	
		SCALE 1 : 1		SHEET 19	
				DATE 12/1/2021	

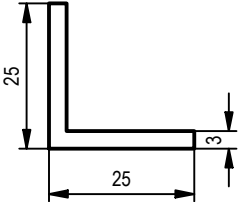
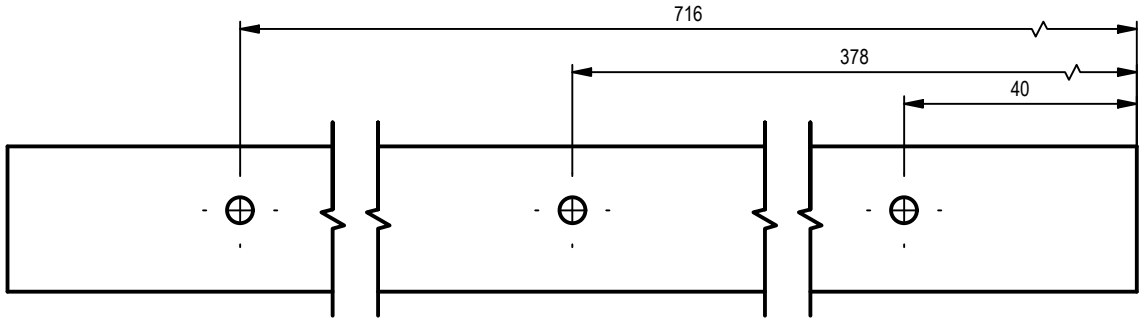
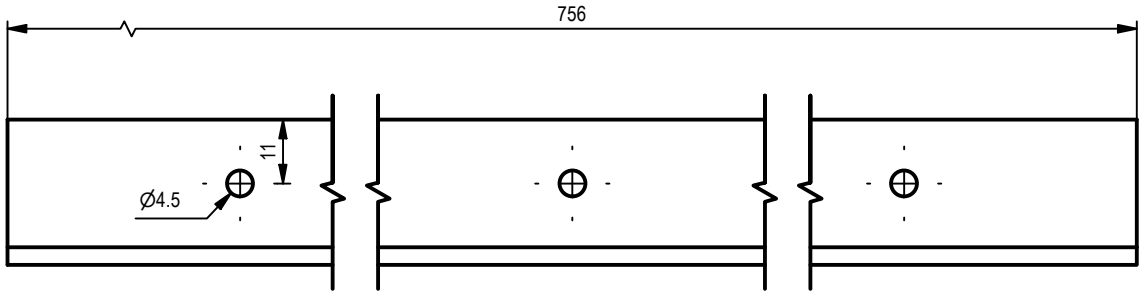
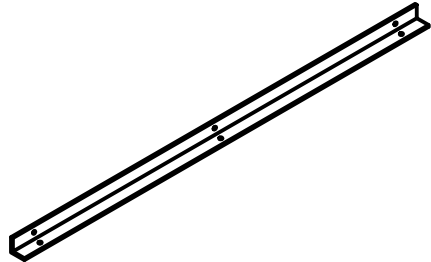

PROJECT TRICYCLE CARGO BIKE		CREATED BY A. PARDO		APPROVED BY D. Jaeger	
PART NAME wl_lacb_2.12_Angle-profile-box		PART CODE 2.12		DOCUMENT TYPE Production	
 Open Source Ecology e.V. Knobelsdorffstr. 22 14059 Berlin www.ose-germany.de +49 (0) 30 / 92282426		LICENSE CERN-OHL		FILE NAME wl_lacb_2.12_Angle-profile-box.ipt	
		SCALE 1 : 1.3		MATERIAL A36	
		VERSION 1.0		QUANTITY 1	
		SHEET 20		DATE 12/1/2021	

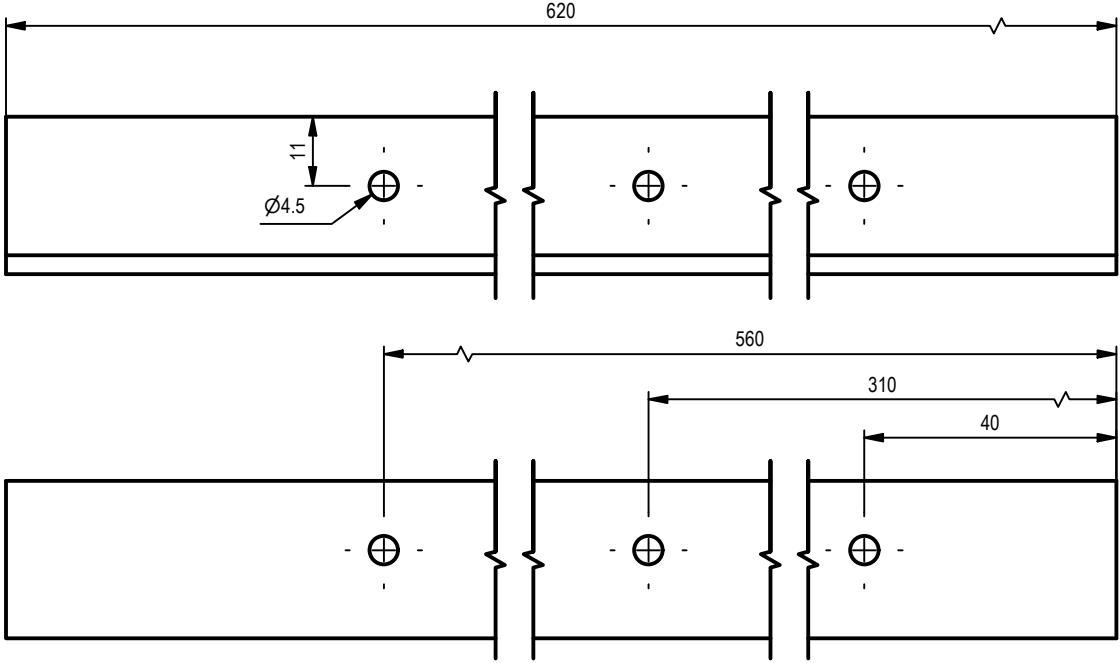
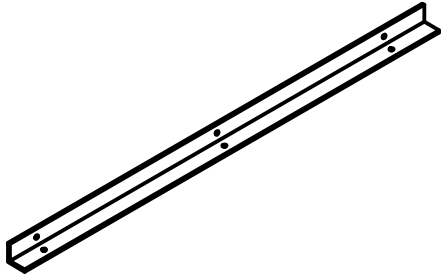

PROJECT TRICYCLE CARGO BIKE		CREATED BY A. PARDO		APPROVED BY D. Jaeger	
PART NAME wl_lacb_2.13_Angle-profile-box		PART CODE 2.13		DOCUMENT TYPE Production	
 <p>Open Source Ecology e.V. Knobelsdorffstr. 22 14059 Berlin www.ose-germany.de +49 (0) 30 / 92282426</p>		LICENSE CERN-OHL		FILE NAME wl_lacb_2.13_Angle-profile-box.ipt	
		SCALE 1 : 1.2		MATERIAL A36	
		VERSION 1.0		QUANTITY 1	
		SHEET 21		DATE 12/1/2021	

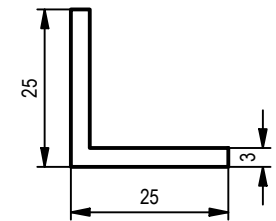
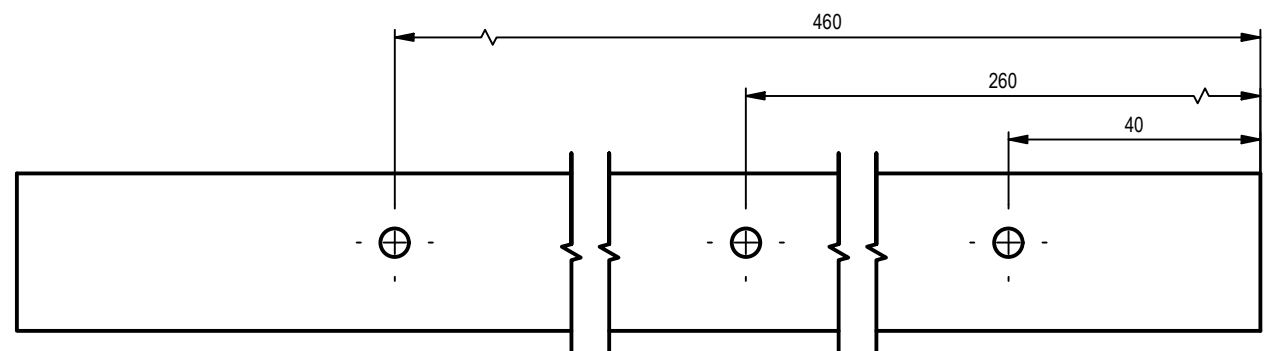
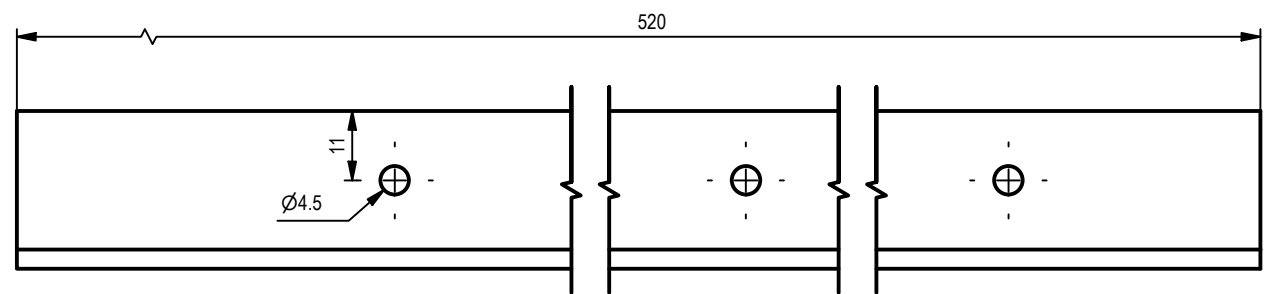
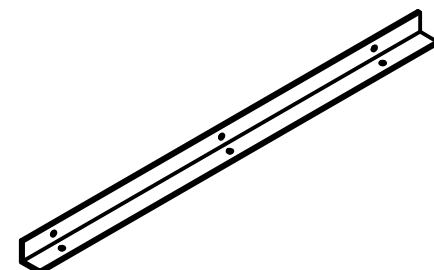

PROJECT TRICYCLE CARGO BIKE		CREATED BY A. PARDO		APPROVED BY D. Jaeger	
PART NAME wl_lacb_2.14_Angle-profile-box		PART CODE 2.14		DOCUMENT TYPE Production	
 Open Source Ecology e.V. Knobelsdorffstr. 22 14059 Berlin www.ose-germany.de +49 (0) 30 / 92282426		LICENSE CERN-OHL		FILE NAME wl_lacb_2.14_Angle-profile-box.ipt	
		SCALE 1 : 1.2		MATERIAL A36	
		VERSION 1.0		QUANTITY 1	
		SHEET 22		DATE 12/1/2021	

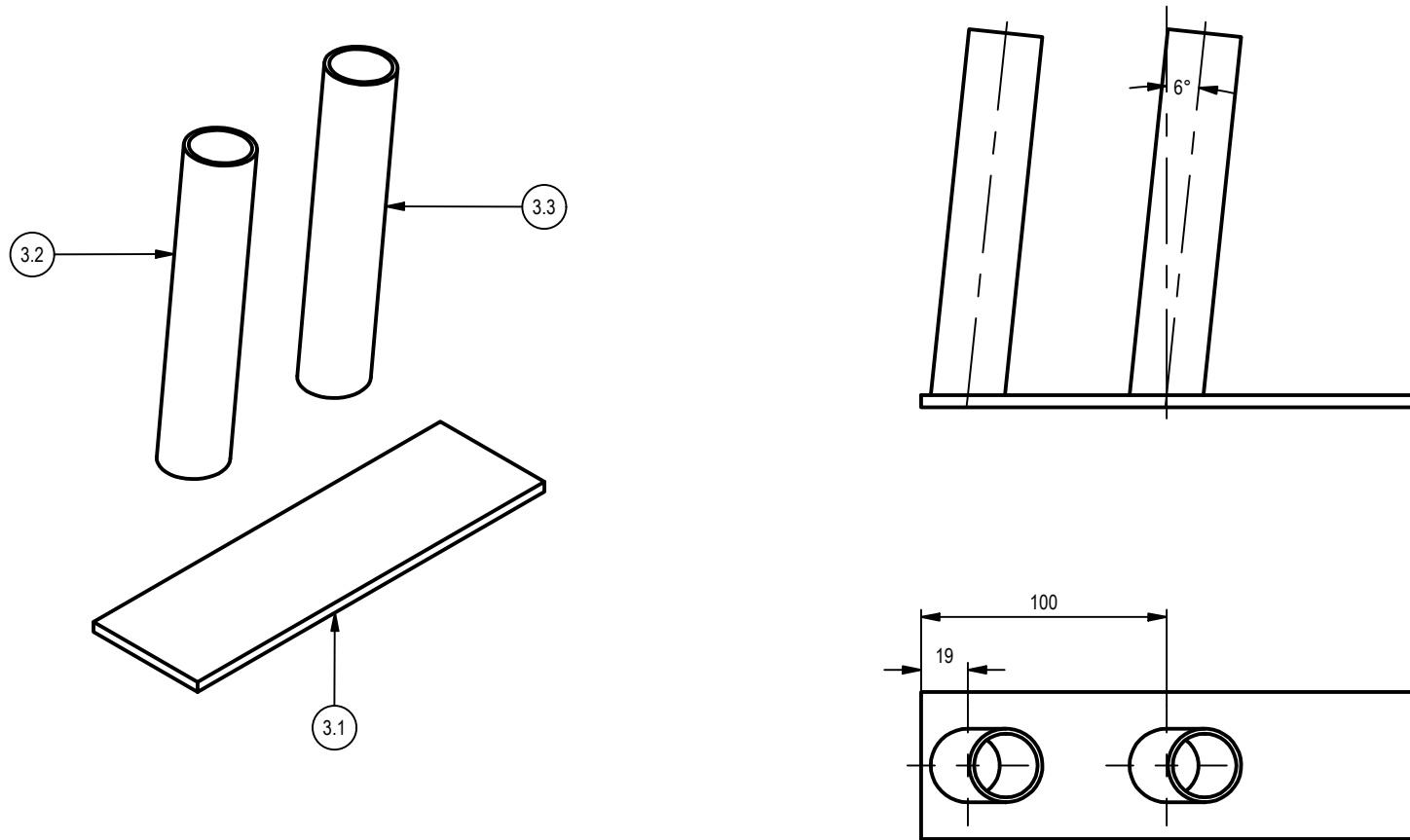

PROJECT TRICYCLE CARGO BIKE		CREATED BY A. PARDO		APPROVED BY D. Jaeger	
PART NAME Assembly3-tricycle cargo bike B		PART CODE 3.0		DOCUMENT TYPE ASSEMBLY	
 <p>Open Source Ecology e.V. Knobelsdorffstr. 22 14059 Berlin www.ose-germany.de +49 (0) 30 / 92282426</p>		LICENSE CERN-OHL		FILE NAME Assembly3-tricycle cargo bike B.iam	
		SCALE 1 / 3		VERSION 1.0	
		SHEET 23		QUANTITY DATE 15/1/2021	

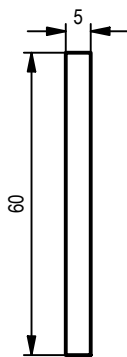
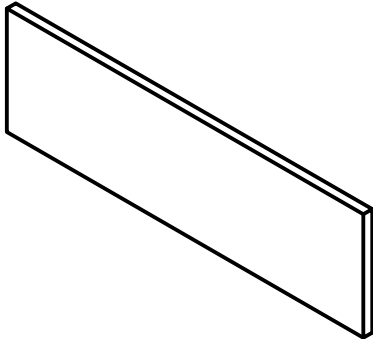

PROJECT TRICYCLE CARGO BIKE		CREATED BY A. PARDO		APPROVED BY D. Jaeger	
PART NAME wl_lacb_3.1_Head tube-plate		PART CODE 3.1		DOCUMENT TYPE Production	
 Open Source Ecology e.V. Knobelsdorffstr. 22 14059 Berlin www.ose-germany.de +49 (0) 30 / 92282426		LICENSE CERN-OHL		FILE NAME wl_lacb_3.1_Head tube-plate.ipt	
		SCALE 1 / 1.5		MATERIAL A36	
		VERSION 1.0		QUANTITY 1	
		SHEET 24		DATE 11/1/2021	

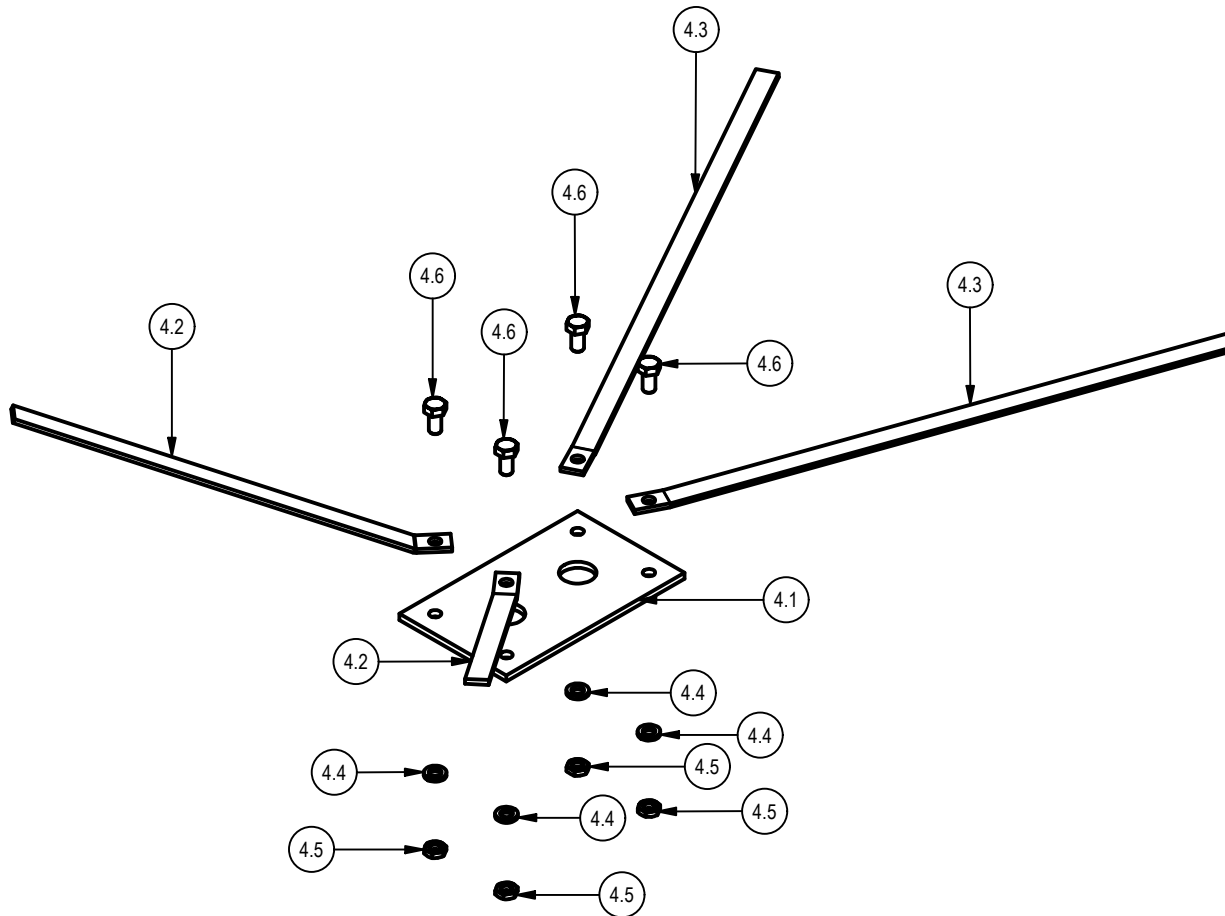

PROJECT TRICYCLE CARGO BIKE		CREATED BY A. PARDO		APPROVED BY D. Jaeger	
PART NAME Assembly4-tricycle cargo bike B		PART CODE 4.0		DOCUMENT TYPE ASSEMBLY	
 <p>Open Source Ecology e.V Knobelsdorffstr. 22 14059 Berlin www.ose-germany.de +49 (0) 30 / 92282426</p>		LICENSE CERN-OHL		FILE NAME Assembly4-tricycle cargo bike B.iam	
		SCALE 1 / 6		VERSION 1.0	
				SHEET 25	
				DATE 15/1/2021	

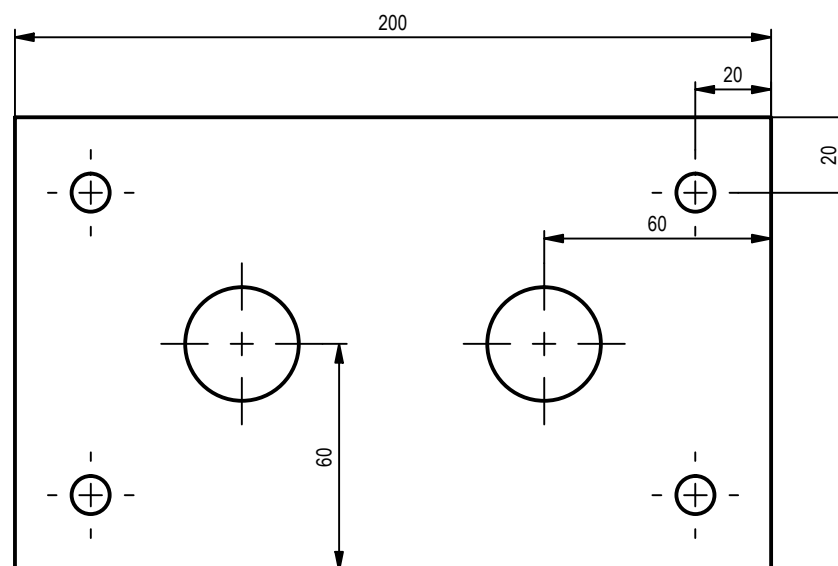
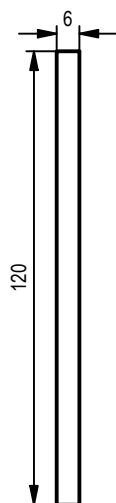
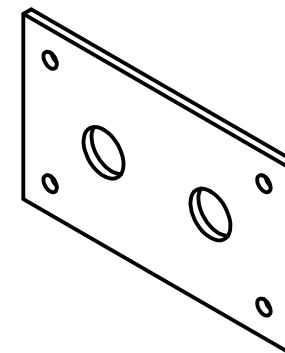

PROJECT TRICYCLE CARGO BIKE		CREATED BY A. PARDO		APPROVED BY D. Jaeger	
PART NAME wl_lacb_4.1_Security-plate		PART CODE 4.1		DOCUMENT TYPE Production	
 Open Source Ecology e.V. Knobelsdorffstr. 22 14059 Berlin www.ose-germany.de +49 (0) 30 / 92282426		LICENSE CERN-OHL		FILE NAME wl_lacb_4.1_Security-plate.ipt	
		SCALE 1 / 2		MATERIAL A36	
		VERSION 1.0		QUANTITY 1	
		SHEET 26		DATE 11/1/2021	

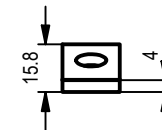
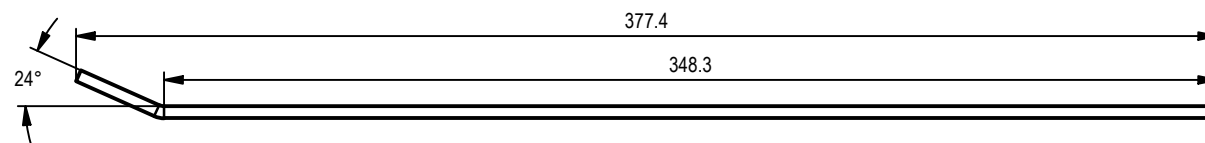
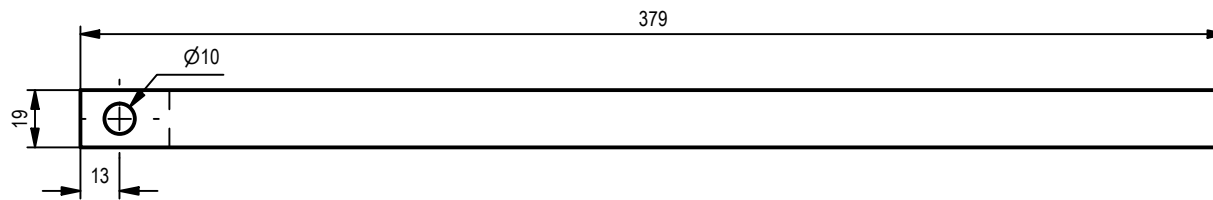
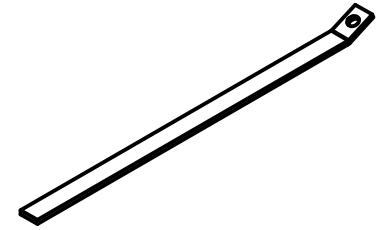

PROJECT TRICYCLE CARGO BIKE		CREATED BY A. PARDO		APPROVED BY D. Jaeger	
PART NAME wl_lacb_4.2_Stru		PART CODE 4.2		DOCUMENT TYPE Production	
 Open Source Ecology e.V. Knobelsdorffstr. 22 14059 Berlin www.ose-germany.de +49 (0) 30 / 92282426		LICENSE CERN-OHL		FILE NAME wl_lacb_4.2_Strut.ipt	
		SCALE 1 / 2.5		MATERIAL A36	
		VERSION 1.0		QUANTITY 1	
		SHEET 27		DATE 11/1/2021	

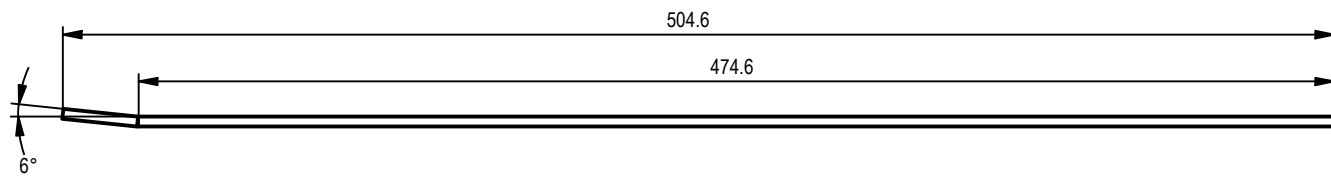
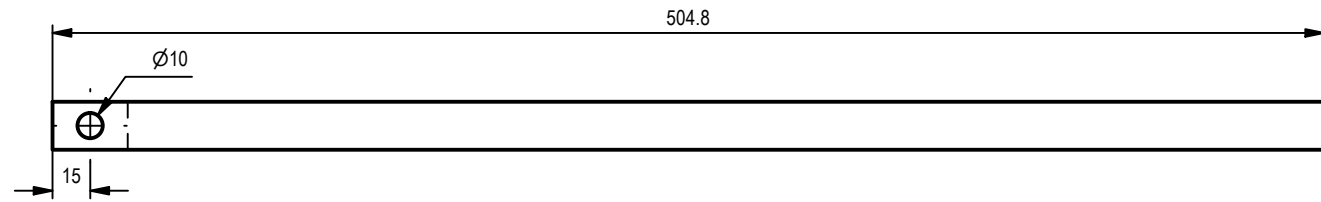
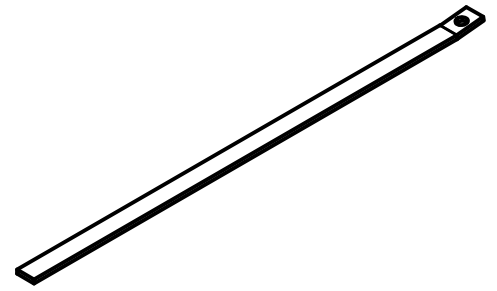

PROJECT TRICYCLE CARGO BIKE		CREATED BY A. PARDO		APPROVED BY D. Jaeger	
PART NAME wl_lacb_4.3_Strut		PART CODE 4.3		DOCUMENT TYPE Production	
 Open Source Ecology e.V. Knobelsdorffstr. 22 14059 Berlin www.ose-germany.de +49 (0) 30 / 92282426		LICENSE CERN-OHL		FILE NAME wl_lacb_4.3_Strut.ipt	
		SCALE 1 / 3		MATERIAL A36	
		VERSION 1.0		QUANTITY 1	
		SHEET 28		DATE 11/1/2021	