







PROJECT BEE HIVE FRAMES	CREATED BY A. PARDO	APPROVED BY		
PART NAME BEE HIVE FRAMES	PART CODE 1	DOCUMENT TYPE ASSEMBLY	MATERIAL WOOD	
 OPEN SOURCE ECOLOGY GERMANY	LICENSE 	FILE NAME BEE HIVE FRAMES.iam	VERSION 1.0	QUANTITY 1
		SCALE 1 / 8	SHEET 1 /	DATE 4/10/2020

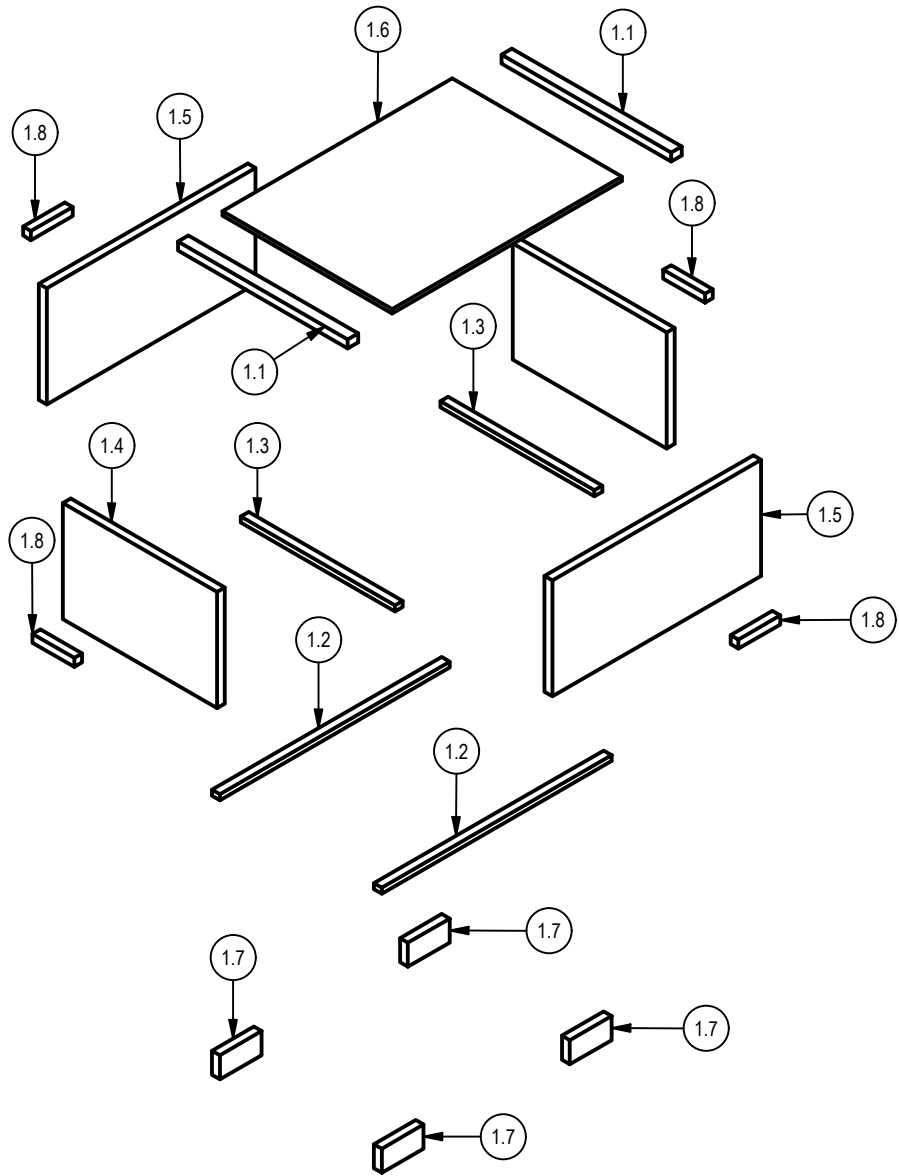

PARTS LIST						
POS.	POS. OLD	QTY	PART NAME	FILE NAME	PART TYPE	SPECIFICATIONS
1		1	BEE HIVE FRAMES	BEE HIVE FRAMES.iam	ASSEMBLY	
1.1		1	PARTS LIST	PARTS LIST.iam	ASSEMBLY	
1.2		1	BROOD CHAMBER	BROOD CHAMBER.iam	ASSEMBLY	
1.3		2	BROOD CHAMBER A	BROOD CAMBER A.ipt	PART	
1.4		2	BROOD CHAMBER B	BROOD CHAMBER B.ipt	PART	
1.5		2	BROOD CHAMBER C	BROOD CHAMBER C.ipt	PART	
1.6		2	BROOD CHAMBER D	BROOD CHAMBER D.ipt	PART	
1.7		2	BROOD CHAMBER E	BROOD CHAMBER E.ipt	PART	
1.8		1	BROOD CHAMBER F	BROOD CHAMBER F.ipt	PART	
1.9		4	BROOD CHAMBER G	BROOD CHAMBER G.ipt	PART	
1.10		4	BROOD CHAMBER H	BROOD CHAMBER H.ipt	PART	
2		1	FRAME	FRAME.iam	ASSEMBLY	
2.1		1	FRAME A	FRAME A.ipt	PART	
2.2		2	FRAME B	FRAME B.ipt	PART	
2.3		1	FRAME C	FRAME C.ipt	PART	
2.4		2	FRAME D	FRAME D.ipt	PART	

PROJECT <b>BEE HIVE FRAMES</b>		CREATED BY <b>A. PARDO</b>		APPROVED BY	
PART NAME <b>BEE HIVE FRAMES</b>		PART CODE <b>1.1</b>		DOCUMENT TYPE <b>ASSEMBLY</b>	
		LICENSE 		MATERIAL <b>WOOD / STEEL METAL</b>	
		FILE NAME PARTS LIST BEE HIVE FRAMES.iam		VERSION <b>1.0</b>	
		SCALE <b>1 / 20</b>		QUANTITY <b>1</b>	
		SHEET <b>2/16</b>		DATE <b>1/10/2020</b>	



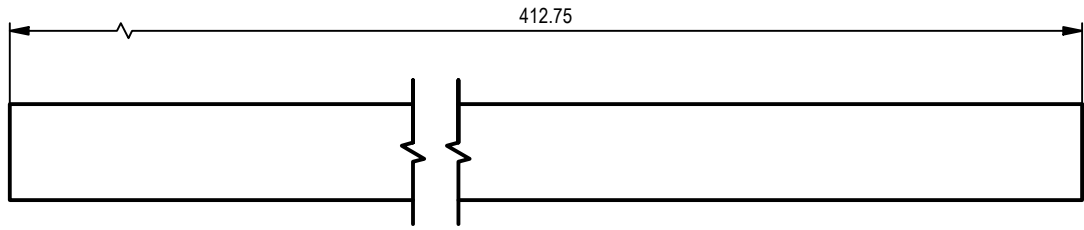
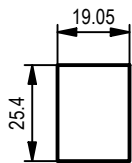
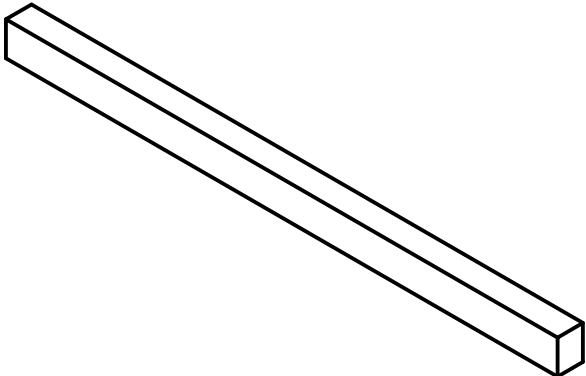

PROJECT BEE HIVE FRAMES		CREATED BY A. PARDO		APPROVED BY	
PART NAME BROOD CHAMBER		PART CODE 1.2		DOCUMENT TYPE ASSEMBLY	
 OPEN SOURCE ECOLOGY GERMANY		LICENSE 		MATERIAL WOOD	
		FILE NAME BROOD CHAMBER.iam		VERSION 1.0	
		SCALE 1 / 13		QUANTITY 1	
		SHEET 1/16		DATE 1/10/2020	



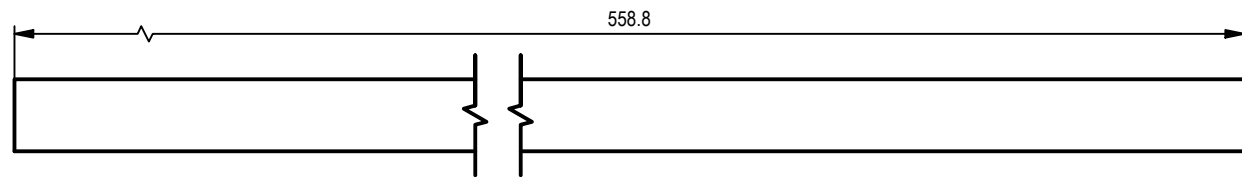
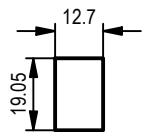
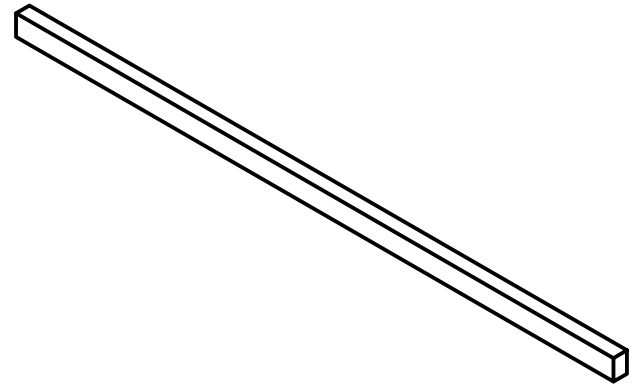

PROJECT BEE HIVE FRAMES	CREATED BY A. PARDO	APPROVED BY		
PART NAME BROOD CHAMBER A	PART CODE 1.3	DOCUMENT TYPE PART	MATERIAL WOOD	
	LICENSE 	FILE NAME BROOD CHAMBER A.ipt	VERSION 1.0	QUANTITY 1
		SCALE 1 / 2	SHEET 4/16	DATE 24/9/2020



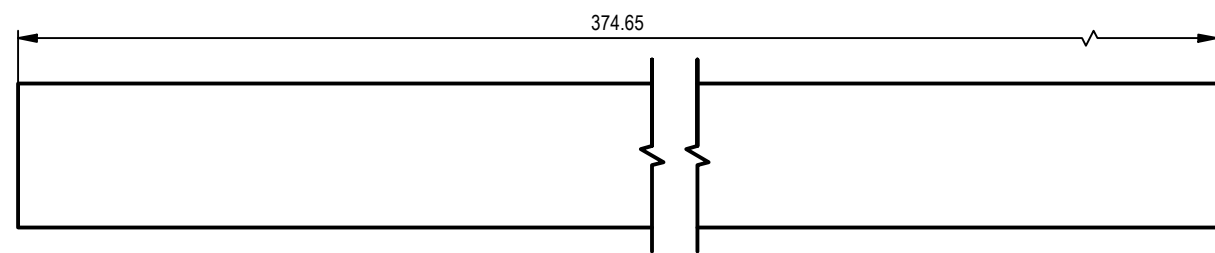
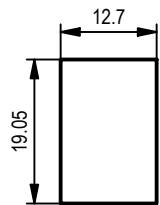
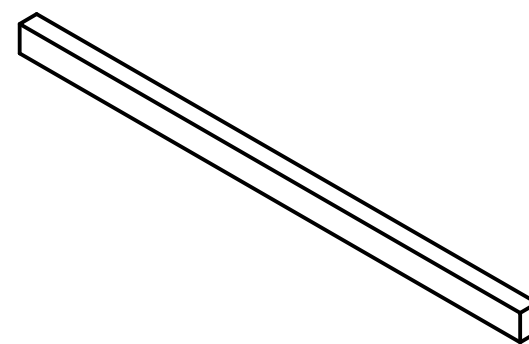

PROJECT BEE HIVE FRAMES	CREATED BY A. PARDO	APPROVED BY		
PART NAME BROOD CHAMBER B	PART CODE 1.4	DOCUMENT TYPE PART	MATERIAL WOOD	
 <small>OPEN SOURCE ECOLOGY GERMANY</small>	LICENSE 	FILE NAME BROOD CHAMBER B.ipt	VERSION 1.0	QUANTITY 1
		SCALE 1 : 2	SHEET 5/16	DATE 24/9/2020



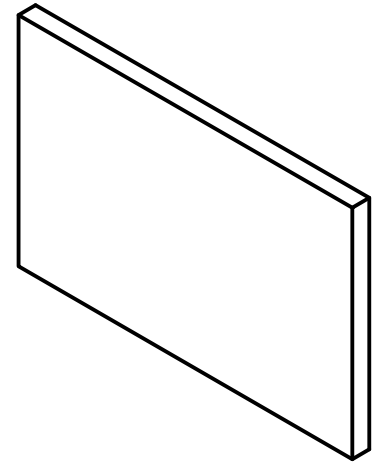
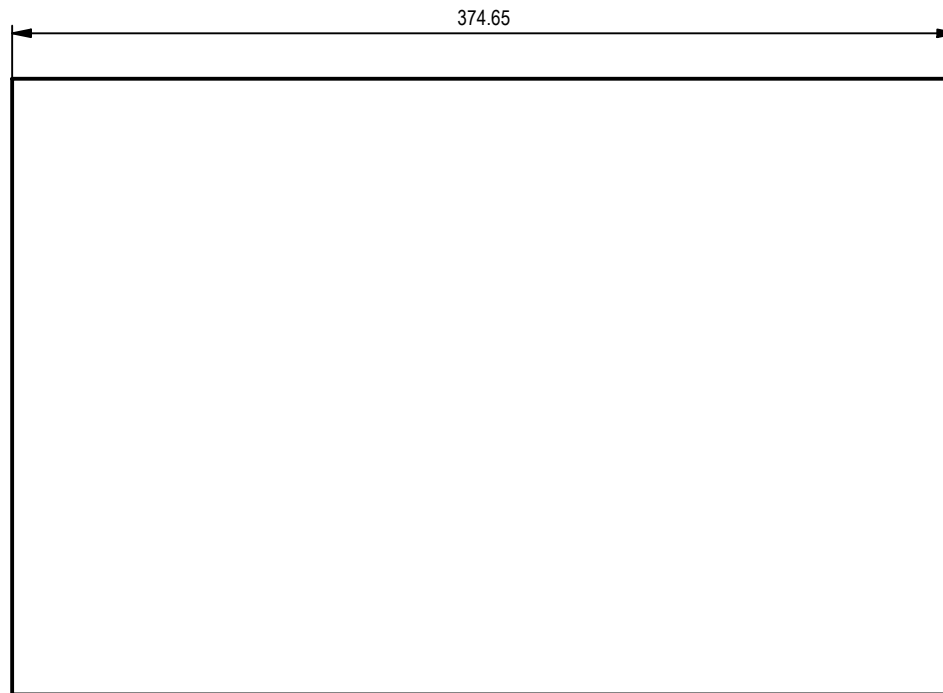
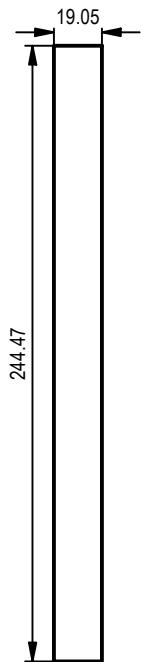

PROJECT BEE HIVE FRAMES	CREATED BY A. PARDO	APPROVED BY		
PART NAME BROOD CHAMBER C	PART CODE 1.5	DOCUMENT TYPE PART	MATERIAL WOOD	
	LICENSE 	FILE NAME BROOD CHAMBER C.ipt	VERSION 1.0	QUANTITY 1
		SCALE 1:1	SHEET 6/16	DATE 24/9/2020



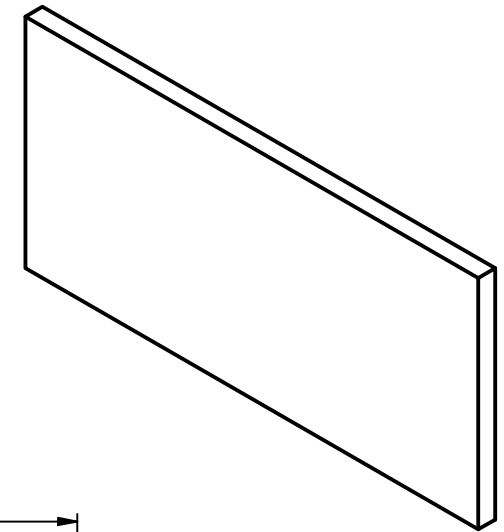
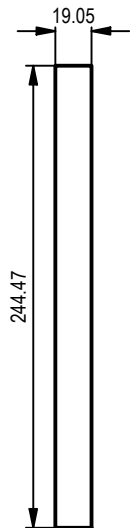

PROJECT BEE HIVE FRAMES	CREATED BY A. PARDO	APPROVED BY		
PART NAME BROOD CHAMBER D	PART CODE 1.6	DOCUMENT TYPE PART	MATERIAL WOOD	
	LICENSE 	FILE NAME BROOD CHAMBER D.ipt	VERSION 1.0	QUANTITY 1
		SCALE 1 / 3	SHEET 7/16	DATE 24/9/2020



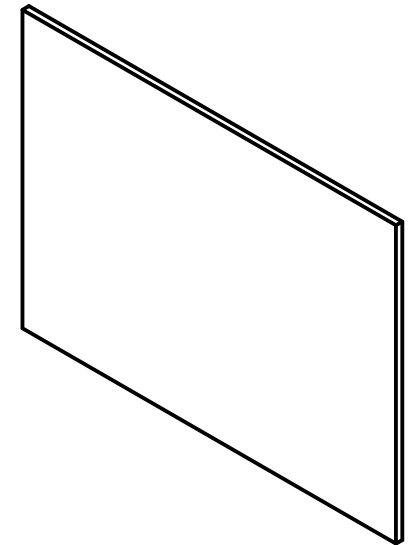
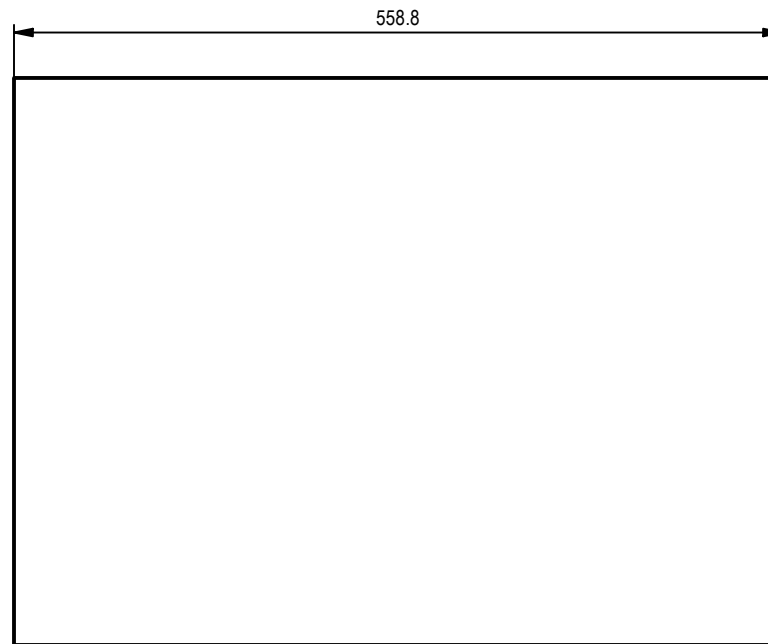
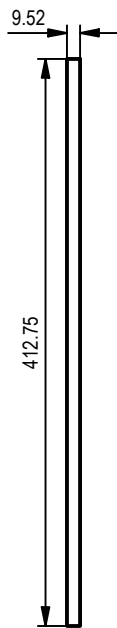

PROJECT BEE HIVE FRAMES	CREATED BY A. PARDO	APPROVED BY		
PART NAME BROOD CHAMBER E	PART CODE 1.7	DOCUMENT TYPE PART	MATERIAL WOOD	
 <small>OPEN SOURCE ECOLOGY GERMANY</small>	LICENSE 	FILE NAME BROOD CHAMBER E.ipt	VERSION 1.0	QUANTITY 1
		SCALE 1 : 4	SHEET 8/16	DATE 24/9/2020





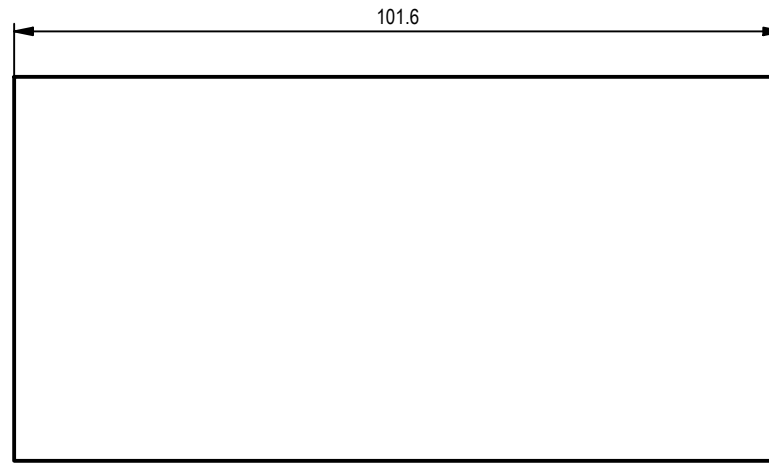
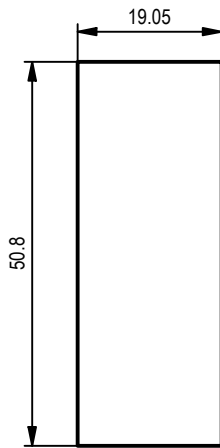
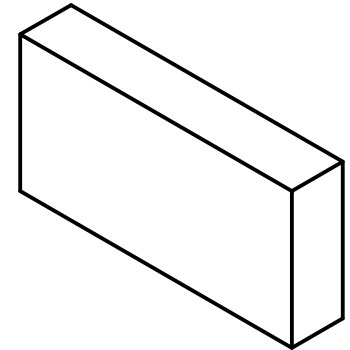

PROJECT BEE HIVE FRAMES	CREATED BY A. PARDO	APPROVED BY		
PART NAME BROOD CHAMBER F	PART CODE 1.8	DOCUMENT TYPE PART	MATERIAL WOOD	
 OPEN SOURCE ECOLOGY GERMANY	LICENSE 	FILE NAME BROOD CHAMBER F.ipt	VERSION 1.0	QUANTITY 1
		SCALE 1 : 5.5	SHEET 9/16	DATE 24/9/2020



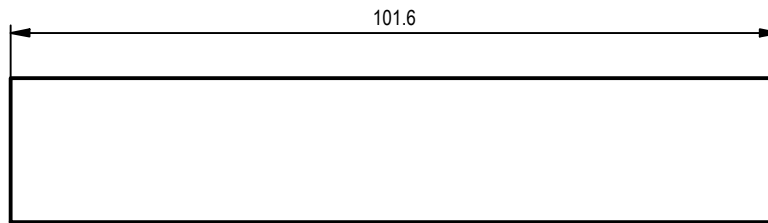
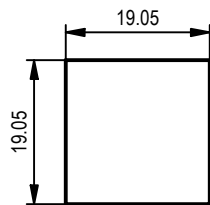
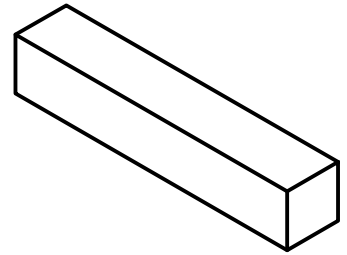

PROJECT BEE HIVE FRAMES	CREATED BY A. PARDO	APPROVED BY		
PART NAME BROOD CHAMBER G	PART CODE 1.9	DOCUMENT TYPE PART	MATERIAL WOOD	
	LICENSE 	FILE NAME BROOD CHAMBER G.ipt	VERSION 1.0	QUANTITY 1
		SCALE 1:1	SHEET 10/16	DATE 24/9/2020



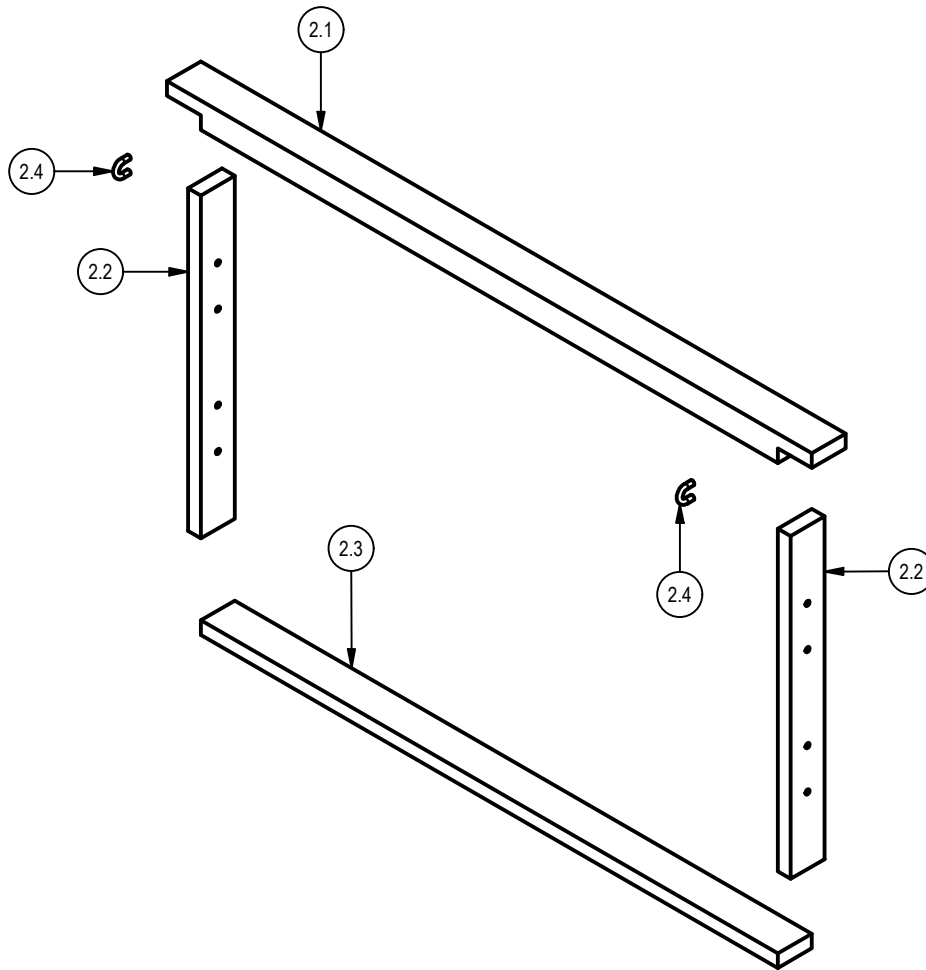

PROJECT BEE HIVE FRAMES	CREATED BY A. PARDO	APPROVED BY		
PART NAME BROOD CHAMBER H	PART CODE 1.10	DOCUMENT TYPE PART	MATERIAL WOOD	
	LICENSE 	FILE NAME BROOD CHAMBER H.ipt	VERSION 1.0	QUANTITY 1
		SCALE 1:1	SHEET 11/16	DATE 1/10/2020

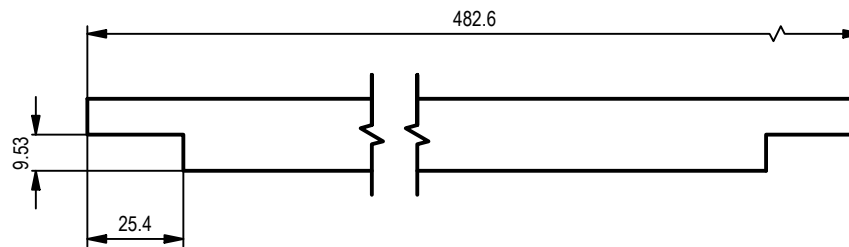
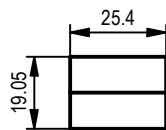
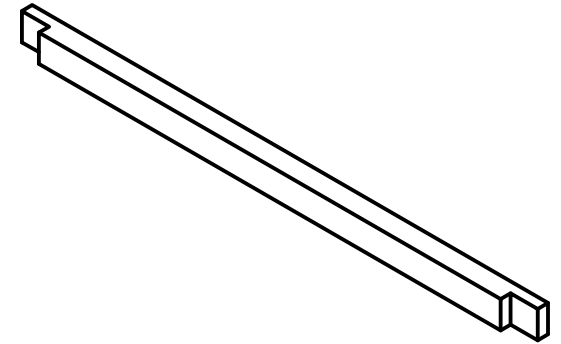

PROJECT BEE HIVE FRAMES	CREATED BY A. PARDO	APPROVED BY		
PART NAME FRAME	PART CODE 2	DOCUMENT TYPE ASSEMBLY	MATERIAL WOOD/STEEL METAL	
 OPEN SOURCE ECOLOGY GERMANY	LICENSE 	FILE NAME FRAME.iam	VERSION 1.0	QUANTITY 1
		SCALE 1 / 4	SHEET 12/16	DATE 1/10/2020



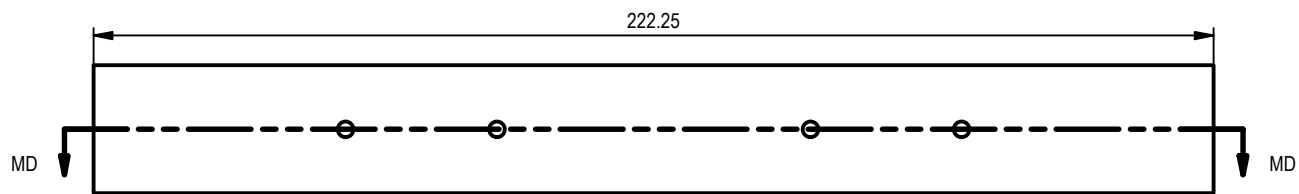
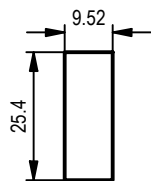
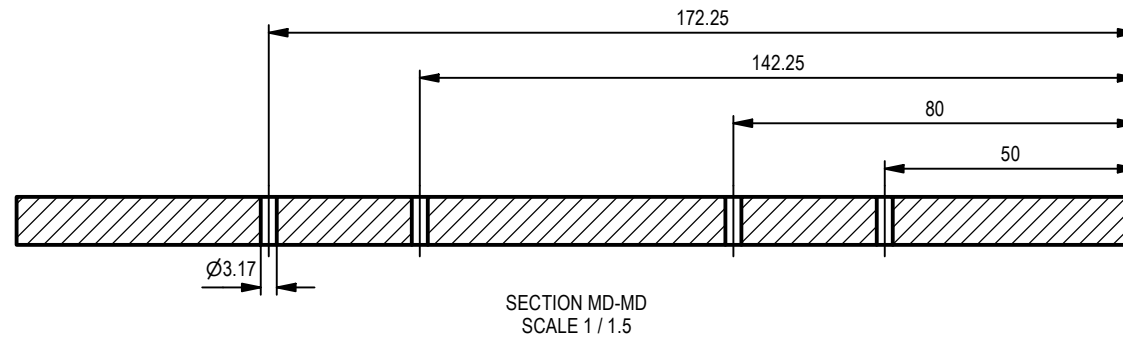
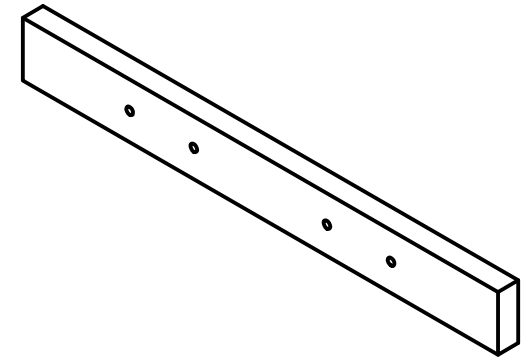

PROJECT BEE HIVE FRAMES	CREATED BY A. PARDO	APPROVED BY		
PART NAME FRAME A	PART CODE 2.1	DOCUMENT TYPE PART	MATERIAL WOOD	
	LICENSE 	FILE NAME FRAME A.ipt	VERSION 1.0	QUANTITY 1
		SCALE 1 / 5	SHEET 13/16	DATE 24/9/2020



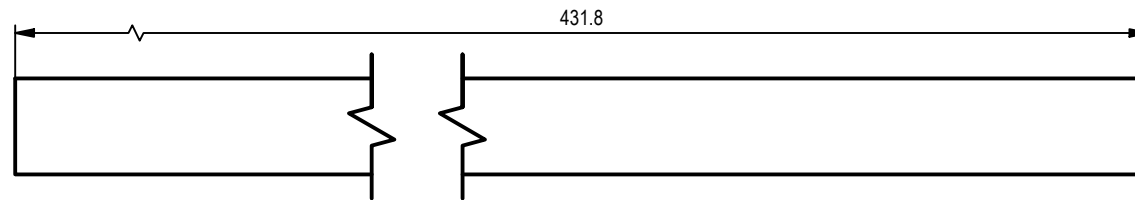
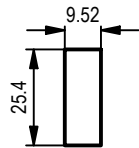
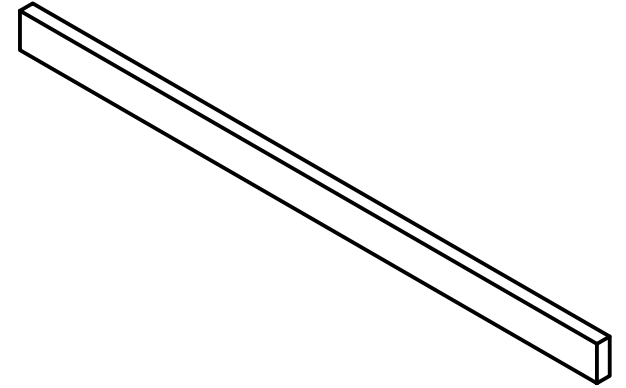

PROJECT BEE HIVE FRAMES		CREATED BY A. PARDO		APPROVED BY	
PART NAME FRAME B		PART CODE 2.2		DOCUMENT TYPE PART	
<p>OPEN SOURCE ECOLOGY GERMANY</p>		LICENSE 		MATERIAL WOOD	
		FILE NAME FRAME B.ipt		VERSION 1.0	QUANTITY 1
		SCALE 1 / 1.5	SHEET 14/16	DATE 24/9/2020	

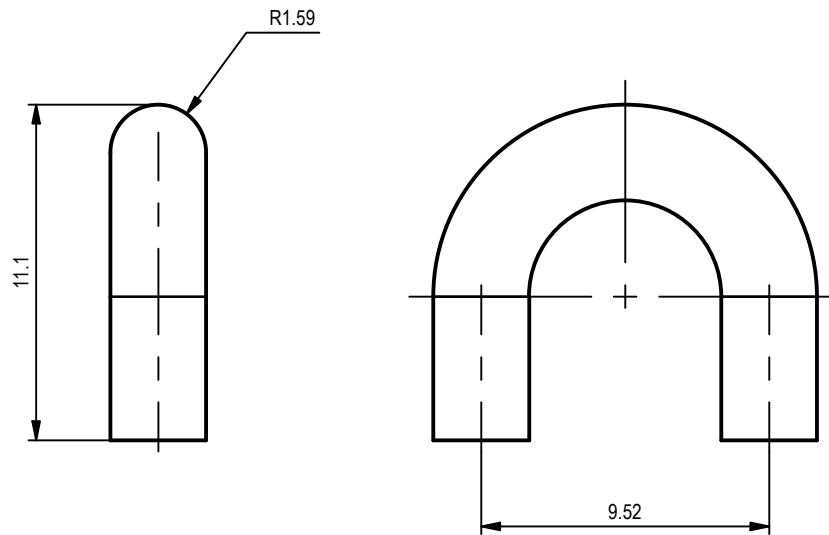
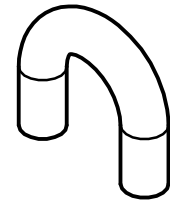

PROJECT BEE HIVE FRAMES	CREATED BY A. PARDO	APPROVED BY		
PART NAME FRAME C	PART CODE 2.3	DOCUMENT TYPE PART	MATERIAL WOOD	
 <small>OPEN SOURCE ECOLOGY GERMANY</small>	LICENSE 	FILE NAME FRAME C.ipt	VERSION 1.0	QUANTITY 1
		SCALE 1 / 2	SHEET 15/16	DATE 24/9/2020



PROJECT BEE HIVE FRAMES		CREATED BY A. PARDO		APPROVED BY	
PART NAME FRAME D		PART CODE 2.4		DOCUMENT TYPE PART	
 OPEN SOURCE ECOLOGY GERMANY		LICENSE 		MATERIAL STEEL METAL	
		FILE NAME FRAME D.ipt		VERSION 1.0	QUANTITY 1
		SCALE 4 : 1	SHEET 16/16	DATE 1/10/2020	