







PROJEKT <b>Bienenbeute</b>	ERSTELLT VON A. PARDO	GENEHMIGT VON		
TEIL-NAME BEE HIVE	TEIL-CODE 1	DOKUMENTTYP ASSEMBY	WERKSTOFF WOOD	
 <small>OPEN SOURCE ECOLOGY GERMANY</small>	LIZENZ	DATEI-NAME BEE HIVE.iam	VERSION 1.0	MENGE 1
		SCALE 1 / 19	SEITE 1/30	DATE 25-09-2020

PARTS LIST						
POS.	POS. OLD	QTY	TEIL NAME	DATEI-NAME	TEIL-TYP	SPEZIFIKATIONEN
1		1	BEE HIVE	BEE HIVE	ASSEMBLY	
1.1		1	PARTS LIST	BROOD CHAMBER.iam	ASSEMBLY	
1.2		1	BROOD CHAMBER	BROOD CHAMBER.iam	ASSEMBLY	
1.3		1	BROOD CHAMBER A	BROOD CHAMBER A.ipt	PART	
1.4		2	BROOD CHAMBER B	BROOD CHAMBER B.ipt	PART	
2		1	REVERSIBLE BOTTOM BOARD	REVERSIBLE BOTTOM BOARD.iam	ASSEMBLY	
2.1		1	REVERSIBLE BOTTOM BOARD A	REVERSIBLE BOTTOM BOARD A.ipt	PART	
2.2		1	REVERSIBLE BOTTOM BOARD B	REVERSIBLE BOTTOM BOARD B.ipt	PART	
2.3		1	REVERSIBLE BOTTOM BOARD C	REVERSIBLE BOTTOM BOARD C.ipt	PART	
2.4		1	REVERSIBLE BOTTOM BOARD D	REVERSIBLE BOTTOM BOARD D.ipt	PART	
2.5		1	REVERSIBLE BOTTOM BOARD E	REVERSIBLE BOTTOM BOARD E.ipt	PART	
3		1	OUTER COVER	OUTER COVER.iam	ASSEMBLY	
3.1		1	OUTER COVER A	OUTER COVER A.ipt	PART	
3.2		2	OUTER COVER B	OUTER COVER B.ipt	PART	
3.3		2	OUTER COVER C	OUTER COVER C.ipt	PART	
4		1	INNER COVER	INNER COVER.iam	ASSEMBLY	
4.1		2	INNER COVER A	INNER COVER A.ipt	PART	
4.2		2	INNER COVER B	INNER COVER B.ipt	PART	
4.3		1	INNER COVER C	INNER COVER C.ipt	PART	
5		1	SHALLOW SUPER	SHALLOW SUPER.iam	ASSEMBLY	
5.1		2	SHALLOW SUPER A	SHALLOW SUPER A.ipt	PART	
5.2		2	SHALLOW SUPER B	SHALLOW SUPER B.ipt	PART	
6		1	BROOD FRAME	BROOD FRAME.iam	ASSEMBLY	
6.1		1	BROOD FRAME A	BROOD FRAME A.ipt	PART	
6.2		2	BROOD FRAME B	BROOD FRAME B.ipt	PART	
6.3		1	BROOD FRAME C	BROOD FRAME C.ipt	PART	
7		1	SHALLOW SUPER FRAME	SHALLOW SUPER FRAME.iam	ASSEMBLY	
6.1		1	BROOD FRAME A	BROOD FRAME A	PART	
6.2		1	BROOD FRAME B	BROOD FRAME B	PART	
7.1		2	SHALLOW SUPER FRAME A	SHALLOW SUPER FRAME A.ipt	PART	

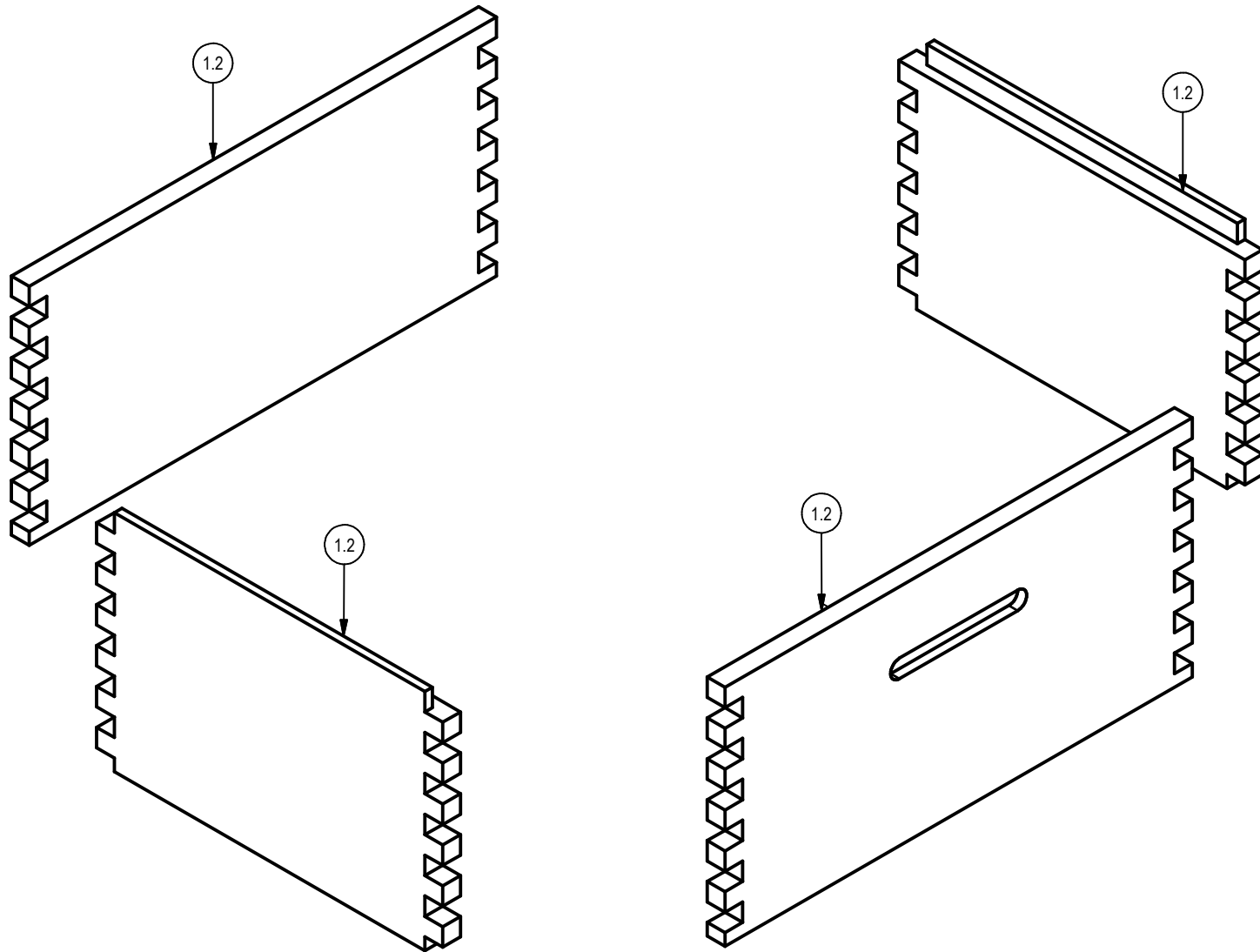

PROJEKT <b>Bienenbeute</b>		ERSTELLT VON A. PARDO		GENEHMIGT VON	
TEIL-NAME BEE HIVE		TEIL-CODE 1.1		DOKUMENTTYP ASSEMBY	
		LIZENZ 		DOKUMENTTYP PART LIST BEE HIVE.iam	
		SCALE 1 / 20		WERKSTOFF WOOD	
				VERSION 1.0	
				MENGE 1	
				DATEI-NAME PART LIST BEE HIVE.iam	
				VERSION 1.0	
				MENGE 1	
				SCALE 1 / 20	
				SEITE 2/28	
				DATE 01-10-2020	



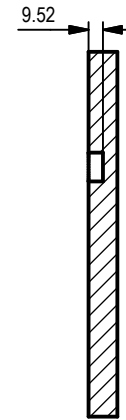
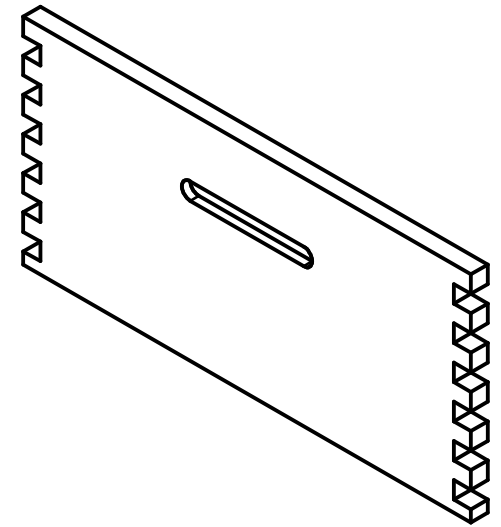
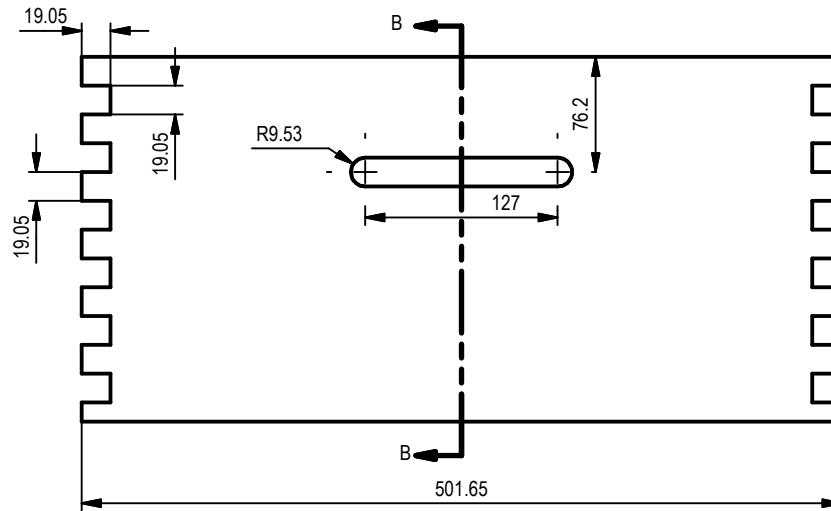
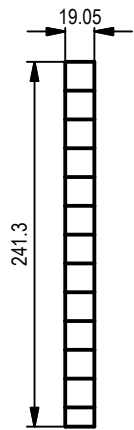

PROJEKT <b>Bienenbeute</b>	ERSTELLT VON A. PARDO	GENEHMIGT VON		
TEIL-NAMEN BROOD CHAMBER	TEIL-CODE 1.2	DOKUMENTTYP ASSEMBLY	WERKSTOFF WOOD	
 OPEN SOURCE ECOLOGY GERMANY	LIZENZ 	DATEI-NAMEN BROOD CHAMBER.iam	VERSION 1.0	MENGE 1
		SCALE 1 : 5	SEITE 3/28	DATE 25-09-2020



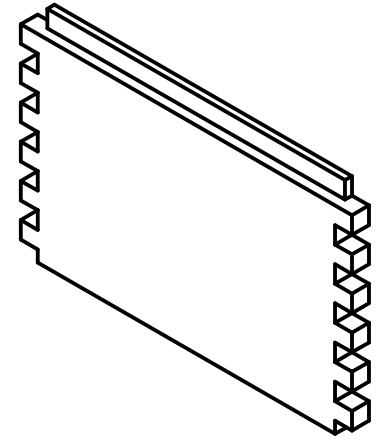
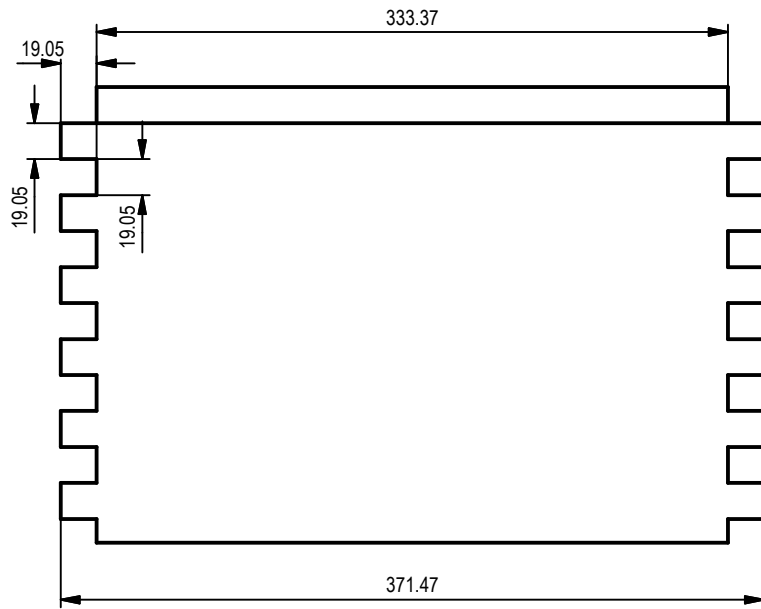
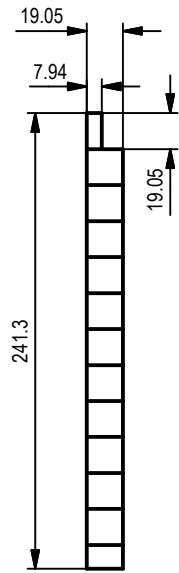

SECTION B-B  
SCALE 1 / 5

PROJEKT <b>Bienenbeute</b>	ERSTELLT VON A. PARDO	GENEHMIGT VON		
TEIL-NAMEN BROOD CHAMBER A	TEIL-CODE 1.3	DOKUMENTTYP ASSEMBY	WERKSTOFF WOOD	
 <small>OPEN SOURCE ECOLOGY GERMANY</small>	LIZENZ 	DATEI-NAMEN BROOD CHAMBER A.ipt	VERSION 1.0	MENGE 1
		SCALE 1 / 5	SEITE 4/28	DATE 25-09-2020



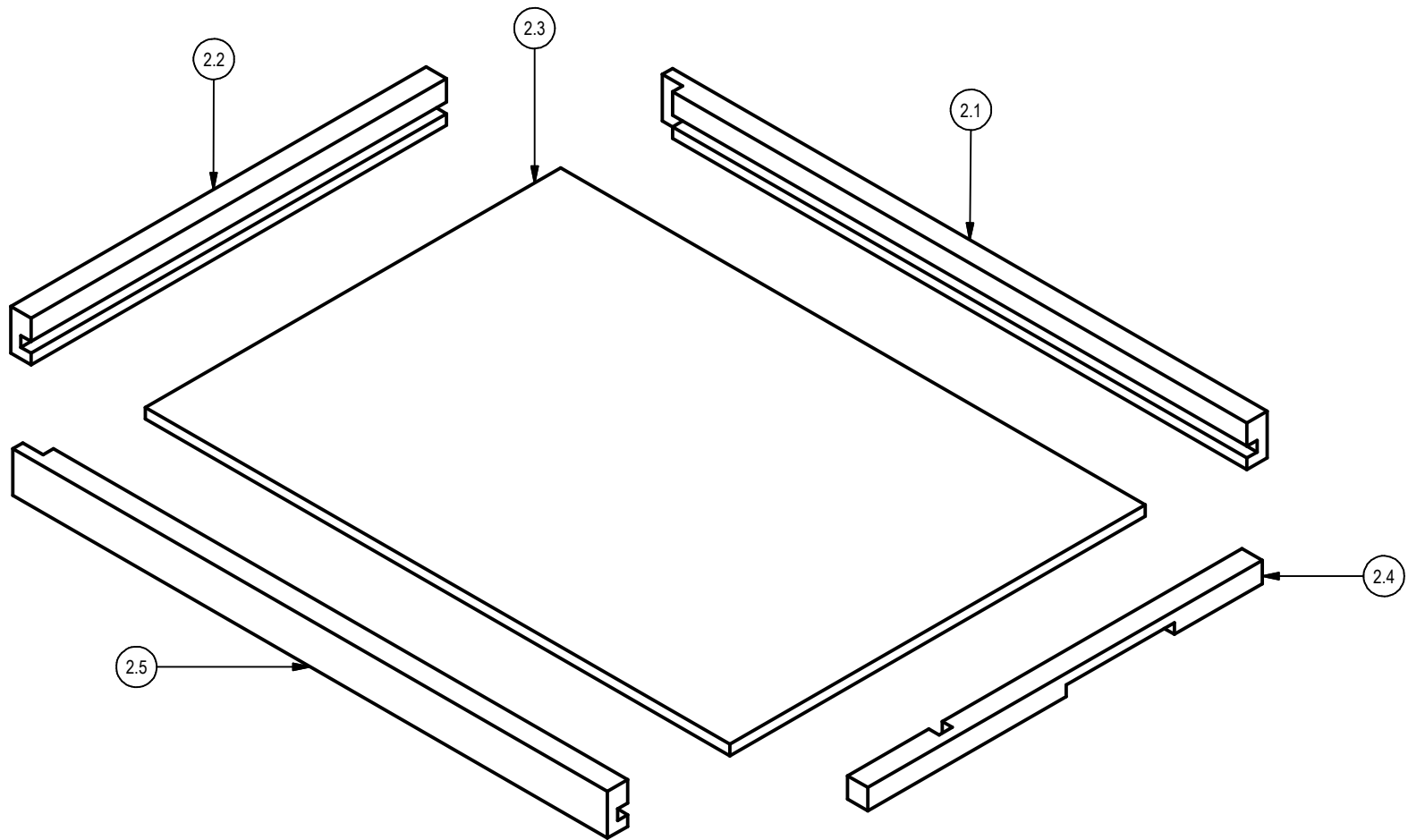

PROJEKT <b>Bienenbeute</b>	ERSTELLT VON A. PARDO	GENEHMIGT VON		
TEIL-NAME BROOD CHAMBER B	TEIL-CODE 1.4	DOKUMENTTYP ASSEMBY	WERKSTOFF WOOD	
 <small>OPEN SOURCE ECOLOGY GERMANY</small>	LIZENZ 	DATEI-NAME BROOD CHAMBER B.ipt	VERSION 1.0	MENGE 1
		SCALE 1 / 4	SEITE 5/30	DATE 25-09-2020



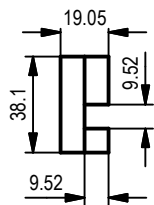
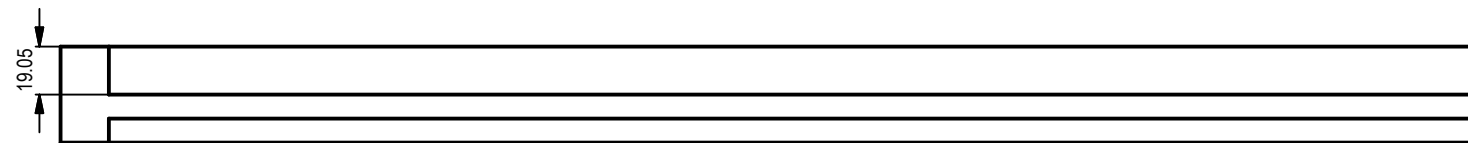
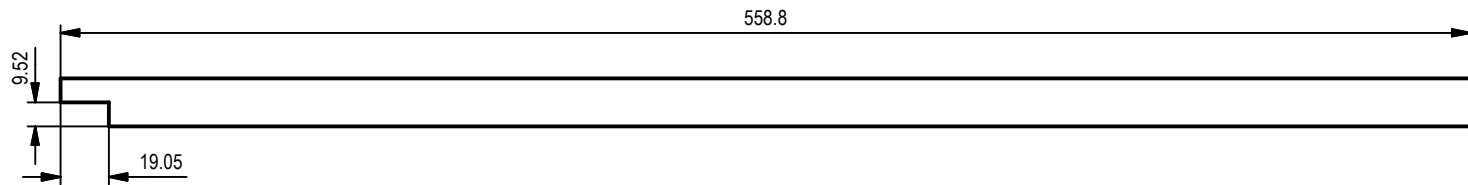
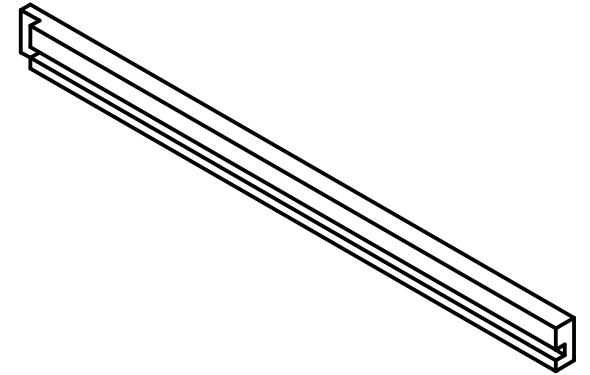

PROJEKT <b>Bienenbeute</b>	ERSTELLT VON A. PARDO	GENEHMIGT VON		
TEIL-NAME REVERSIBLE BOTTOM BOARD	TEIL-CODE 2	DOKUMENTTYP ASSEMBY	WERKSTOFF WOOD	
 OPEN SOURCE ECOLOGY GERMANY	LIZENZ 	DATEI-NAME REVERSIBLE BOTTOM BOARD.iam	VERSION 1.0	MENGE 1
		SCALE 1 / 4.5	SEITE 6/28	DATE 01-10-2020



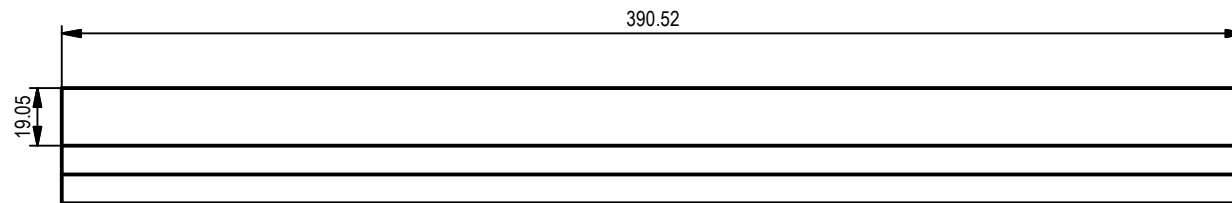
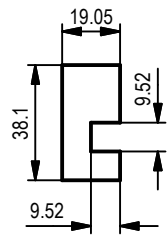
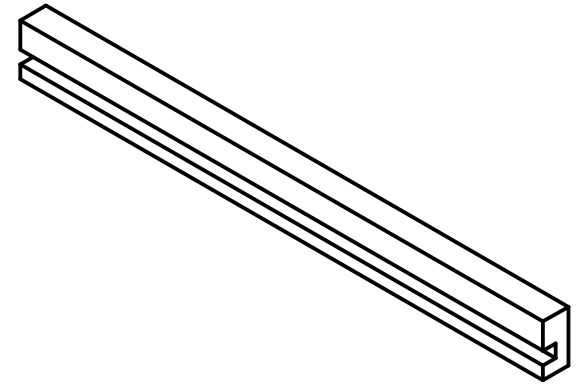

PROJEKT <b>Bienenbeute</b>	ERSTELLT VON A. PARDO	GENEHMIGT VON		
TEIL-NAME REVERSIBLE BOTTOM BOARD A	TEIL-CODE 2.1	DOKUMENTTYP ASSEMBY	WERKSTOFF WOOD	
 <small>OPEN SOURCE ECOLOGY GERMANY</small>	LIZENZ	DATEI-NAME REVERSIBLE BOTTOM BOARD A.ipt	VERSION 1.0	MENGE 1
		SCALE 1 / 3	SEITE 7/28	DATE 25-09-2020



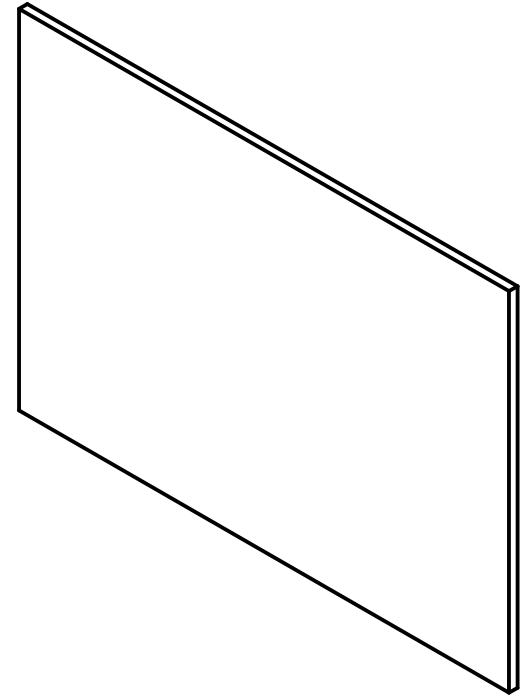
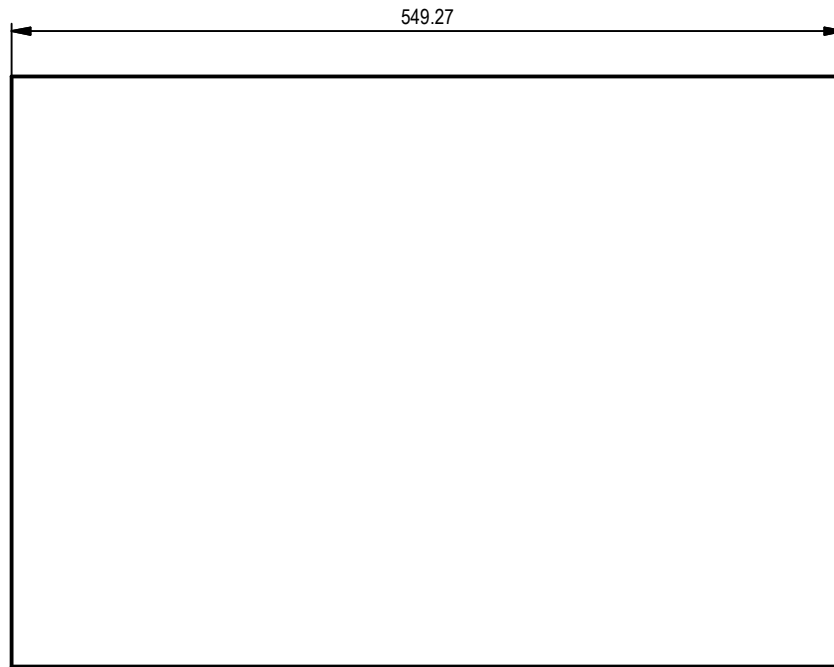
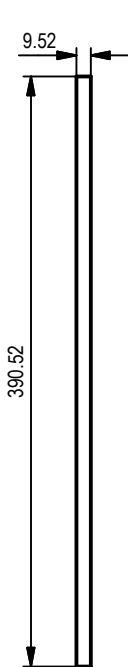

PROJEKT <b>Bienenbeute</b>	ERSTELLT VON A. PARDO	GENEHMIGT VON		
TEIL-NAME REVERSIBLE BOTTOM BOARD B	TEIL-CODE 2.2	DOKUMENTTYP ASSEMBY	WERKSTOFF WOOD	
 <small>OPEN SOURCE ECOLOGY GERMANY</small>	LIZENZ 	DATEI-NAME REVERSIBLE BOTTOM BOARD B.dwt	VERSION 1.0	MENGE 1
		SCALE 1 / 2.5	SEITE 8/28	DATE 25-09-2020





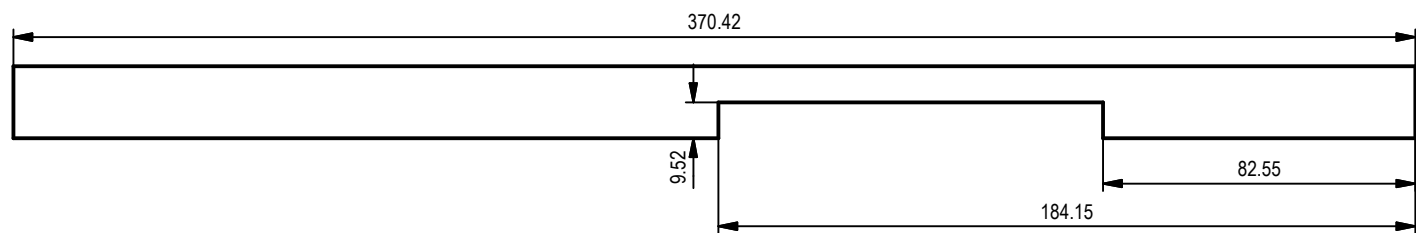
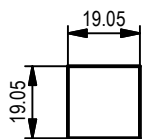
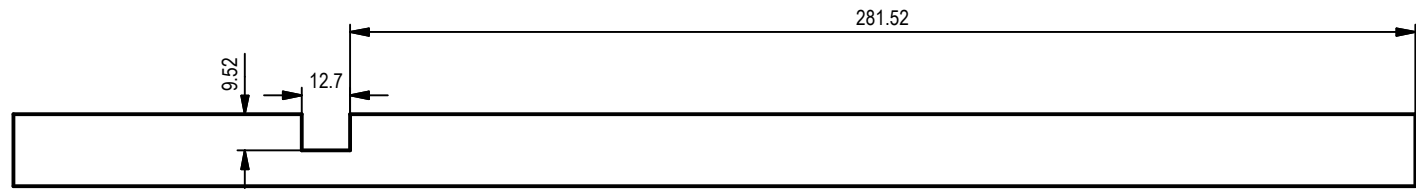
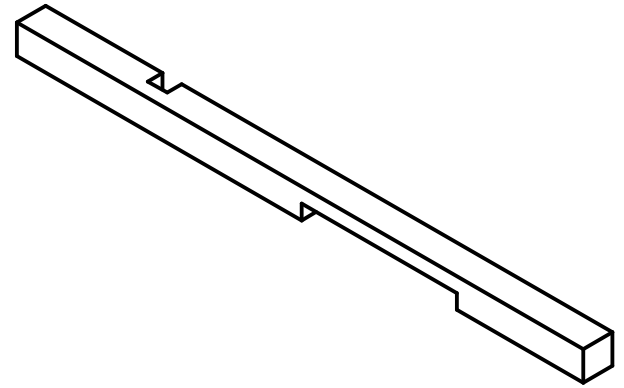

PROJEKT <b>Bienenbeute</b>	ERSTELLT VON A. PARDO	GENEHMIGT VON			
TEIL-NAME REVERSIBLE BOTTOM BOARD C	TEIL-CODE 2.3	DOKUMENTTYP ASSEMBY	WERKSTOFF WOOD		
 <small>OPEN SOURCE ECOLOGY GERMANY</small>	LIZENZ 	DATEI-NAME REVERSIBLE BOTTOM BOARD C.dwt	VERSION 1.0	MENGE 1	
		SCALE 1 / 5	SEITE 9/28	DATE 25-09-2020	



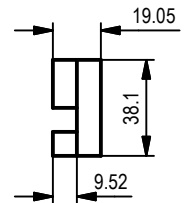
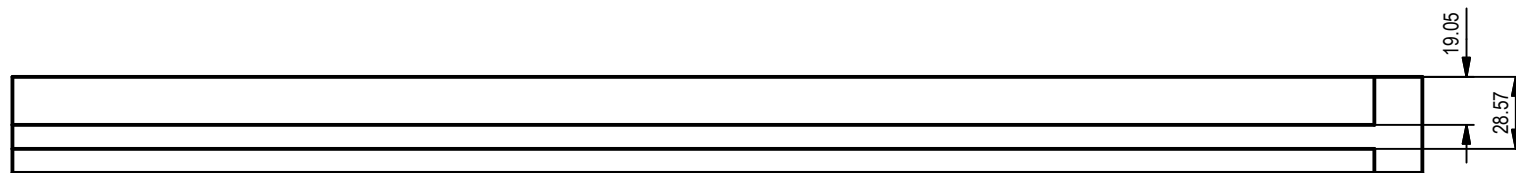
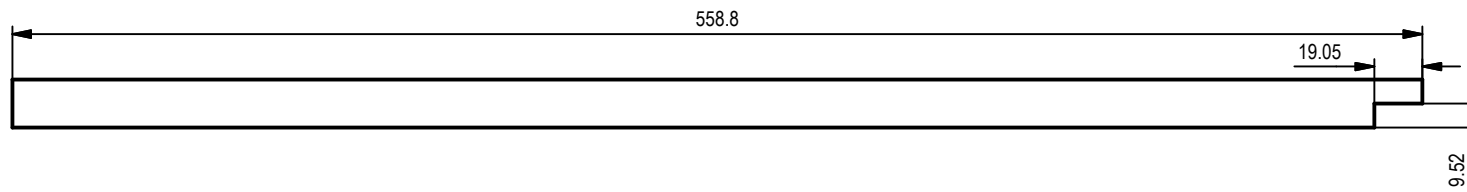
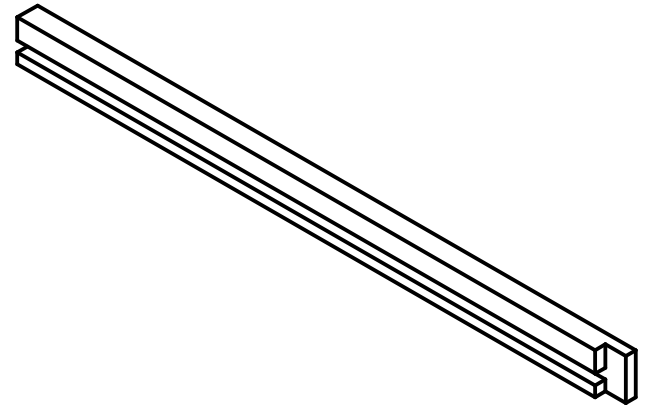

PROJEKT <b>Bienenbeute</b>	ERSTELLT VON A. PARDO	GENEHMIGT VON		
TEIL-NAMEN REVERSIBLE BOTTOM BOARD D	TEIL-CODE 2.4	DOKUMENTTYP ASSEMBY	WERKSTOFF WOOD	
	LIZENZ 	DATEI-NAMEN REVERSIBLE BOTTOM BOARD D.dwt	VERSION 1.0	MENGE 1
		SCALE 1 / 2	SEITE 10/28	DATE 25-09-2020



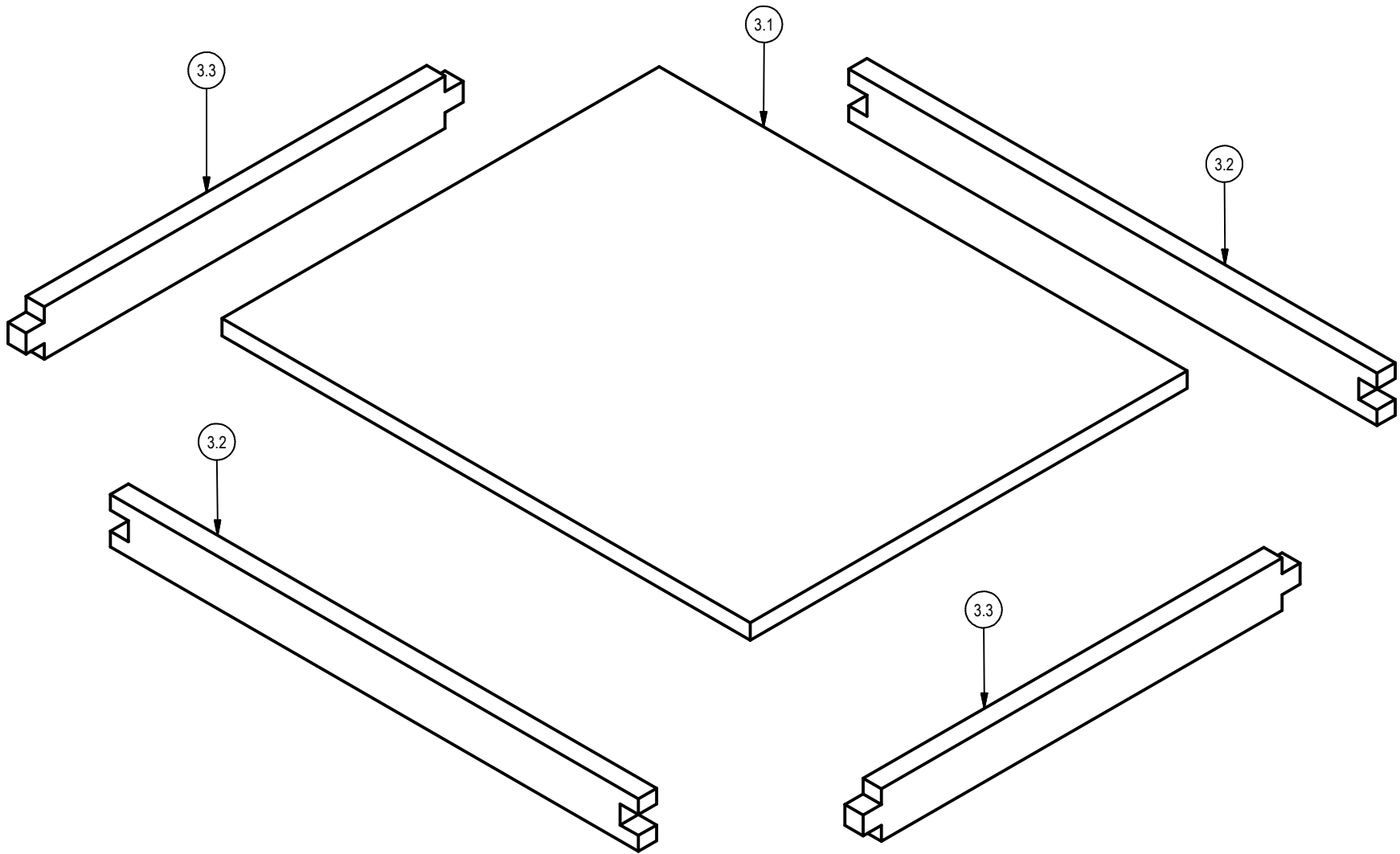

PROJEKT <b>Bienenbeute</b>	ERSTELLT VON A. PARDO	GENEHMIGT VON			
TEIL-NAME REVERSIBLE BOTTOM BOARD E	TEIL-CODE 2.5	DOKUMENTTYP ASSEMBY	WERKSTOFF WOOD		
	LIZENZ 	DATEI-NAME REVERSIBLE BOTTOM BOARD E.djt	VERSION 1.0	MENGE 1	
		SCALE 1 / 3	SEITE 11/28	DATE 25-09-2020	



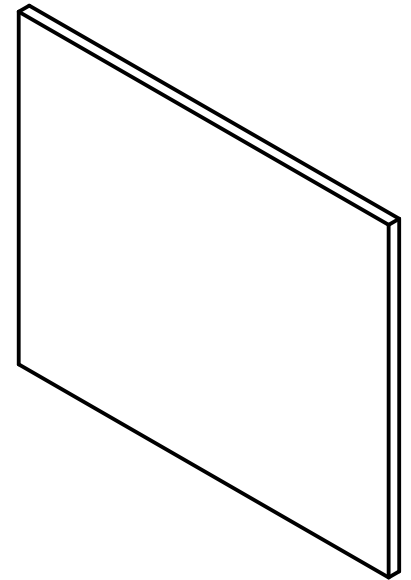
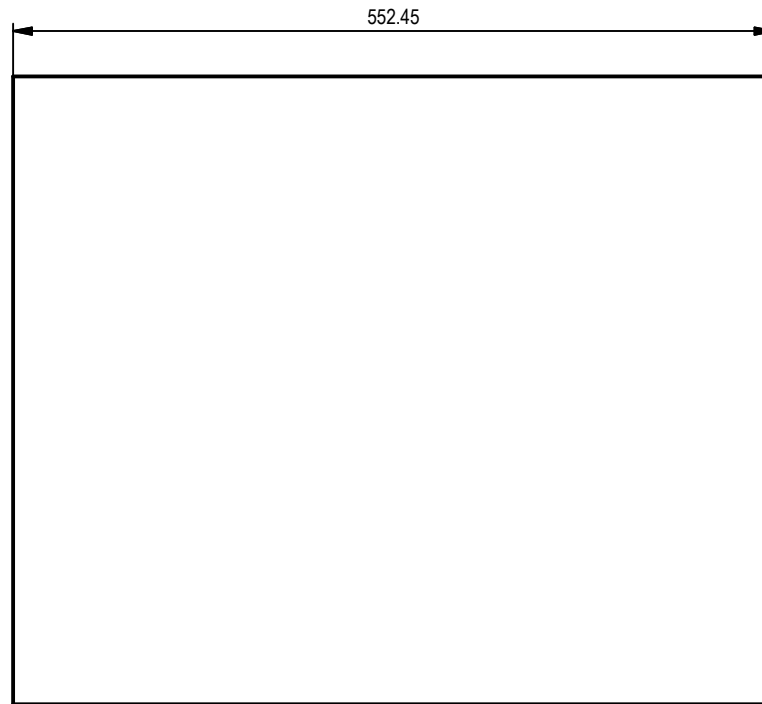
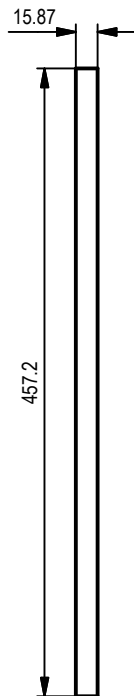

PROJEKT <b>Bienenbeute</b>	ERSTELLT VON A. PARDO	GENEHMIGT VON		
TEIL-NAME OUTER COVER	TEIL-CODE 3	DOKUMENTTYP ASSEMBY	WERKSTOFF WOOD	
 <small>OPEN SOURCE ECOLOGY GERMANY</small>	LIZENZ	DATEI-NAME OUTER COVER.iam	VERSION 1.0	MENGE 1
		SCALE 1 / 4.5	SEITE 12/28	DATE 25-09-2020



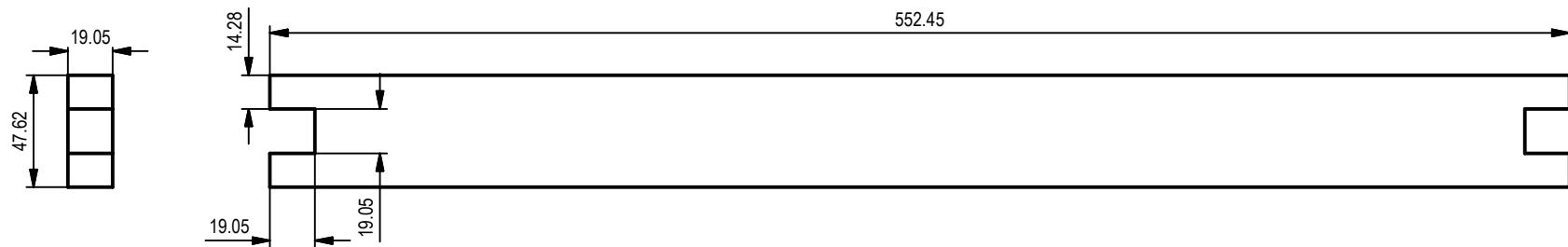
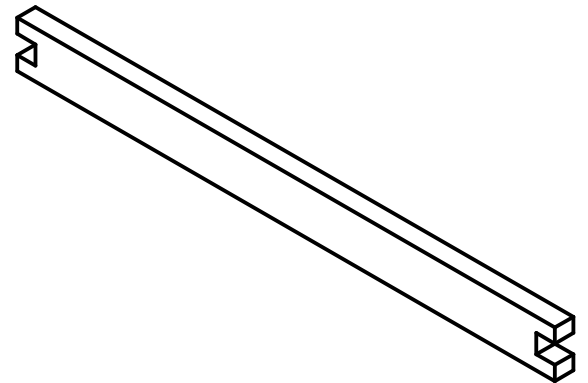

PROJEKT <b>Bienenbeute</b>	ERSTELLT VON A. PARDO	GENEHMIGT VON		
TEIL-NAME OUTER COVER A	TEIL-CODE 3.1	DOKUMENTTYP ASSEMBY	WERKSTOFF WOOD	
 <small>OPEN SOURCE ECOLOGY GERMANY</small>	LIZENZ 	DATEI-NAME OUTER COVER A.ipt	VERSION 1.0	MENGE 1
		SCALE 1 / 5.5	SEITE 13/28	DATE 25-09-2020



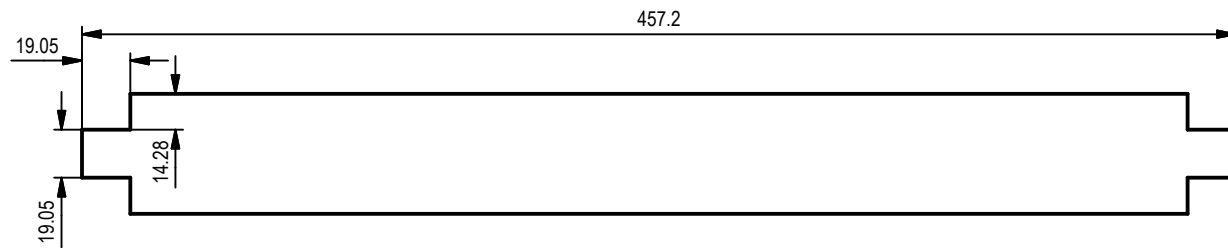
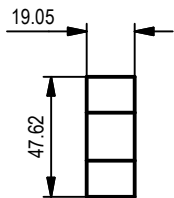
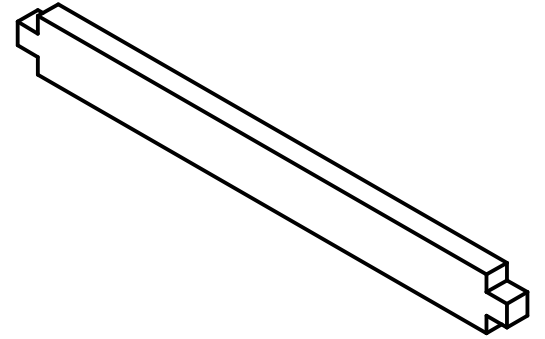

PROJEKT <b>Bienenbeute</b>	ERSTELLT VON A. PARDO	GENEHMIGT VON		
TEIL-NAME OUTER COVER B	TEIL-CODE 3.2	DOKUMENTTYP ASSEMBY	WERKSTOFF WOOD	
 <small>OPEN SOURCE ECOLOGY GERMANY</small>	LIZENZ 	DATEI-NAME OUTER COVER B.ipt	VERSION 1.0	MENGE 1
		SCALE 1 / 3	SEITE 14/28	DATE 25-09-2020



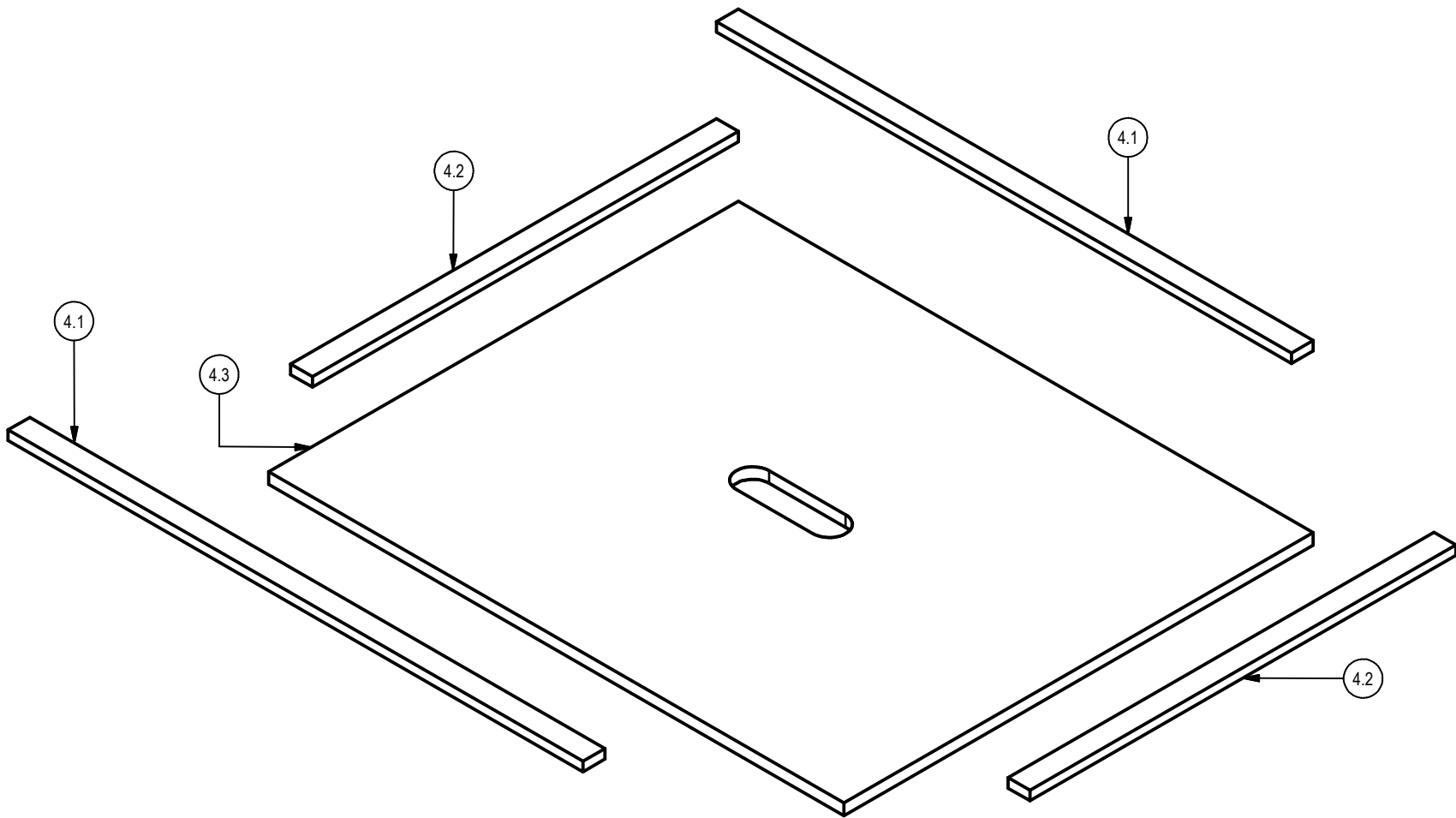

PROJEKT <b>Bienenbeute</b>	ERSTELLT VON A. PARDO	GENEHMIGT VON		
TEIL-NAME OUTER COVER C	TEIL-CODE 3.3	DOKUMENTTYP ASSEMBY	WERKSTOFF WOOD	
 <small>OPEN SOURCE ECOLOGY GERMANY</small>	LIZENZ	DATEI-NAME	VERSION	MENGE
		OUTER COVER C.ipt	1.0	1
		SCALE	SEITE	DATE
		1 / 3	15/28	25-09-2020



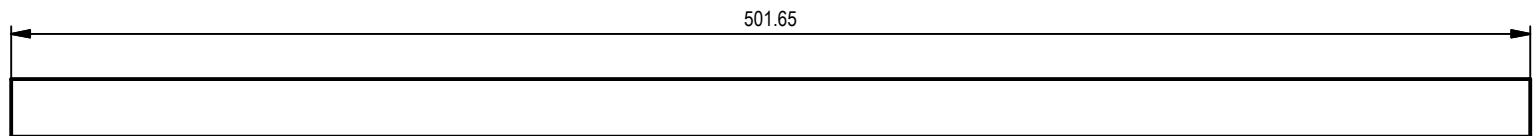
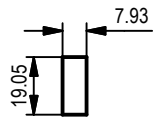
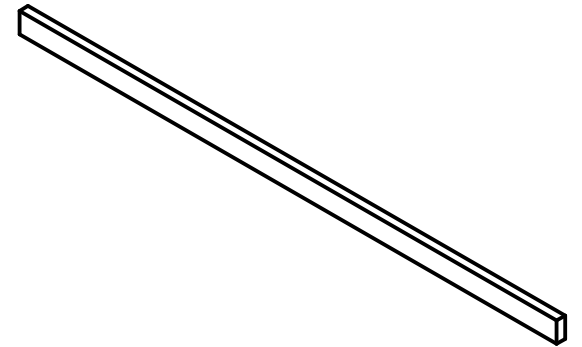

PROJEKT <b>Bienenbeute</b>	ERSTELLT VON A. PARDO	GENEHMIGT VON		
TEIL-NAME INNER COVER	TEIL-CODE 4	DOKUMENTTYP ASSEMBY	WERKSTOFF WOOD	
 <small>OPEN SOURCE ECOLOGY GERMANY</small>	LIZENZ 	DATEI-NAME INNER COVER.iam	VERSION 1.0	MENGE 1
		SCALE 1 / 4	SEITE 16/28	DATE 25-09-2020





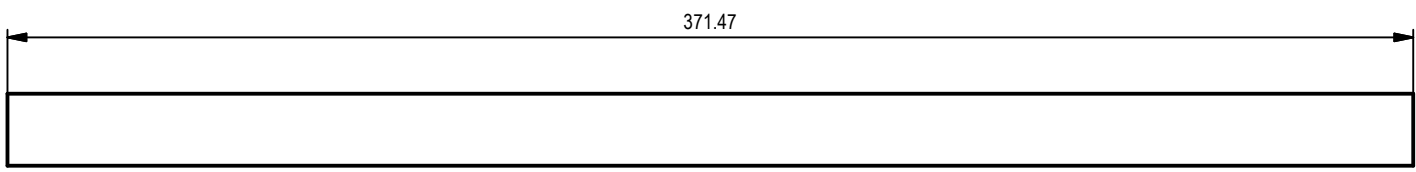
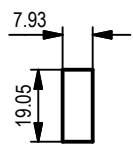
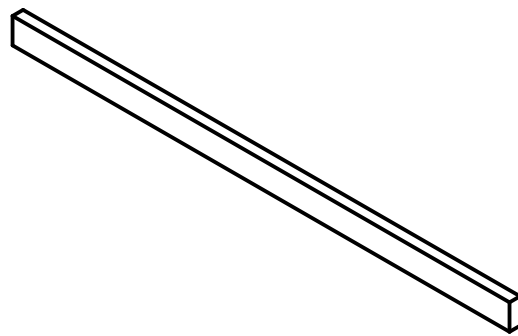

PROJEKT <b>Bienenbeute</b>	ERSTELLT VON A. PARDO	GENEHMIGT VON		
TEIL-NAME INNER COVER A	TEIL-CODE 4.1	DOKUMENTTYP ASSEMBY	WERKSTOFF WOOD	
 <small>OPEN SOURCE ECOLOGY GERMANY</small>	LIZENZ	DATEI-NAME	VERSION	MENGE
		INNER COVER A.ipt	1.0	1
		SCALE 1 / 2.5	SEITE 17/28	DATE 25-09-2020



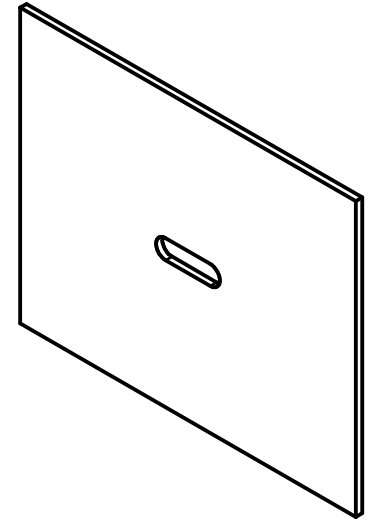
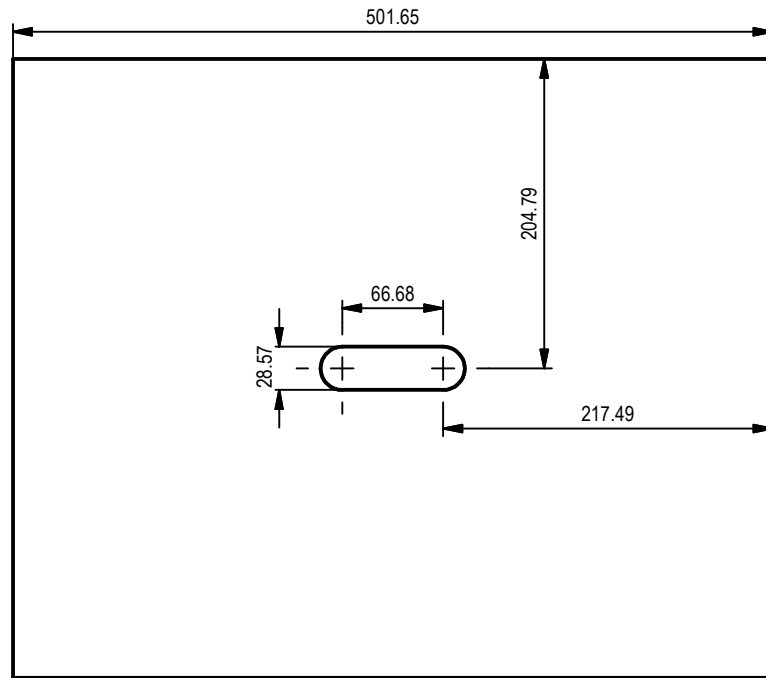
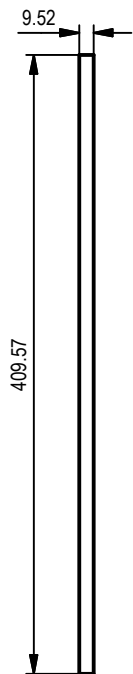

PROJEKT <b>Bienenbeute</b>	ERSTELLT VON A. PARDO	GENEHMIGT VON			
TEIL-NAME INNER COVER B	TEIL-CODE 4.2	DOKUMENTTYP ASSEMBY	WERKSTOFF WOOD		
	LIZENZ	DATEI-NAME INNER COVER B.ipt	VERSION 1.0	MENGE 1	
			SCALE 1 / 2	SEITE 18/28	DATE 25-09-2020



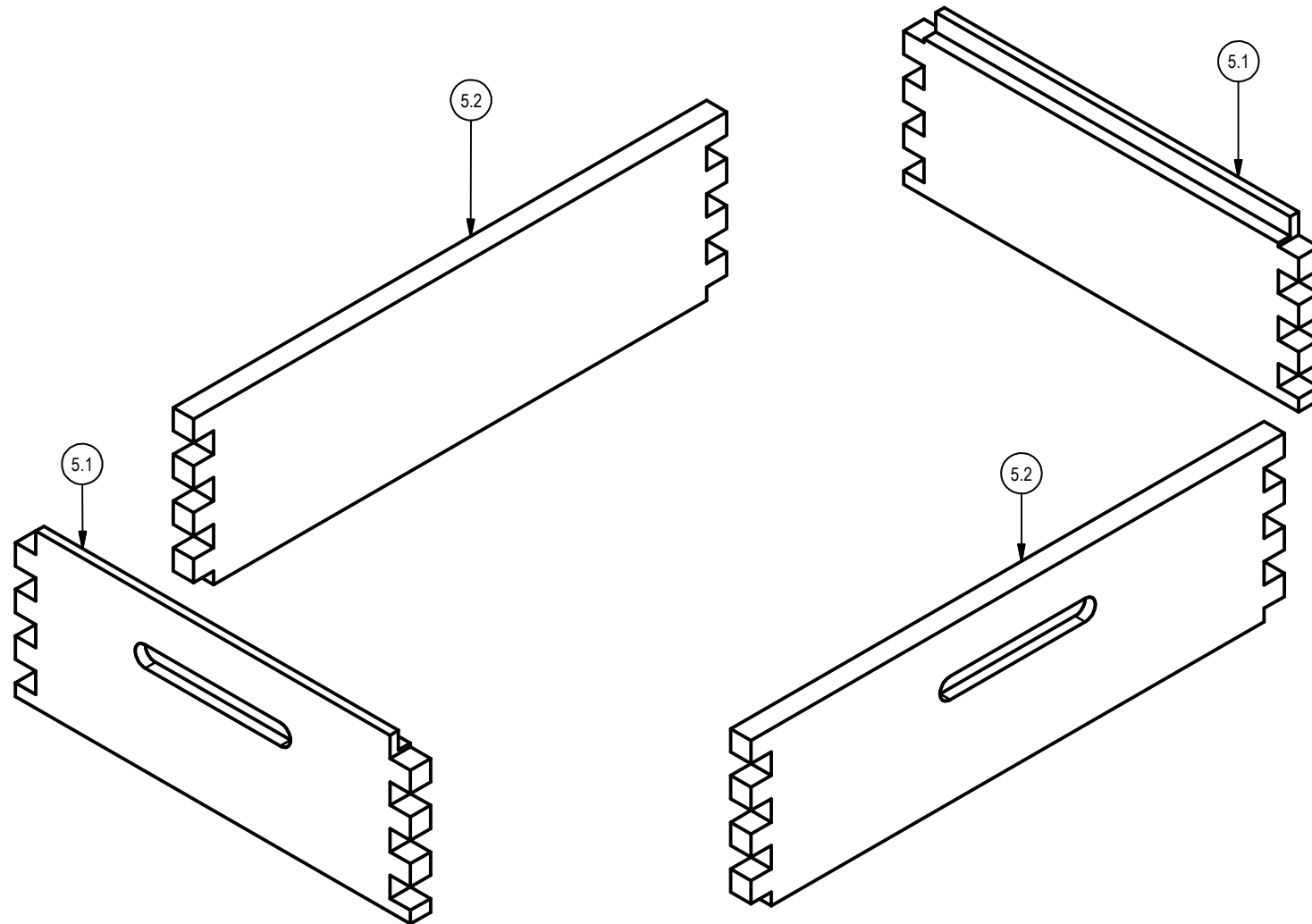

PROJEKT <b>Bienenbeute</b>	ERSTELLT VON A. PARDO	GENEHMIGT VON		
TEIL-NAME INNER COVER C	TEIL-CODE 4.3	DOKUMENTTYP ASSEMBY	WERKSTOFF WOOD	
 <small>OPEN SOURCE ECOLOGY GERMANY</small>	LIZENZ	DATEI-NAME INNER COVER C.ipt	VERSION 1.0	MENGE 1
		SCALE 1 / 5	SEITE 19/28	DATE 25-09-2020



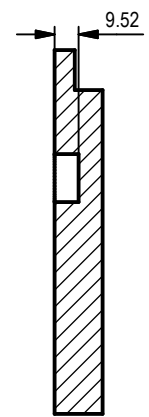
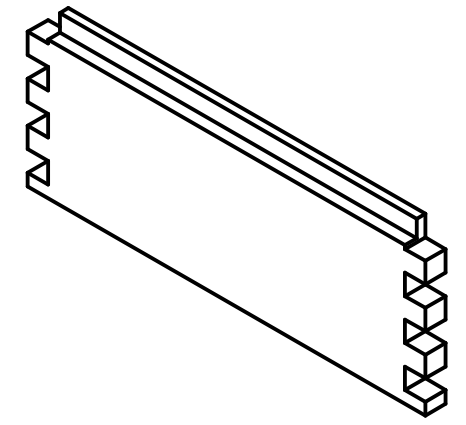
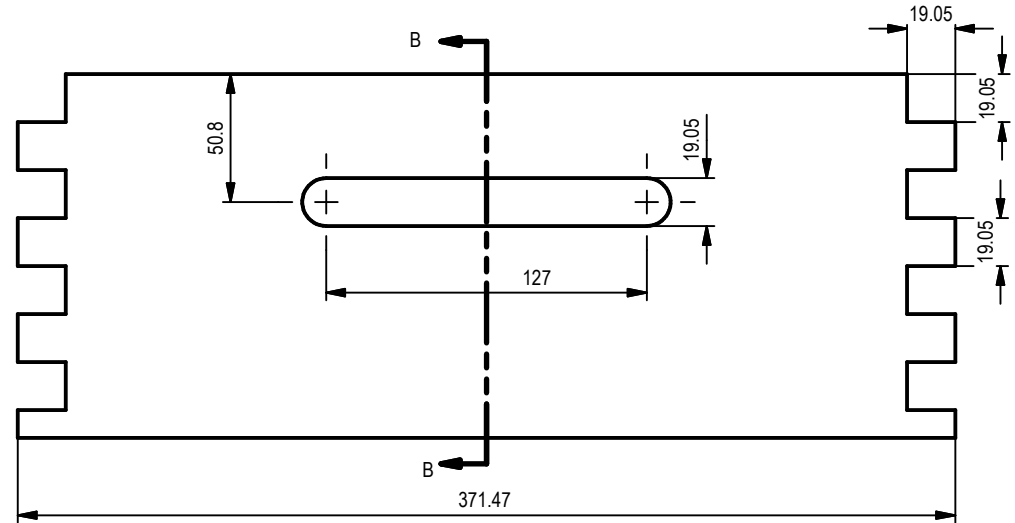
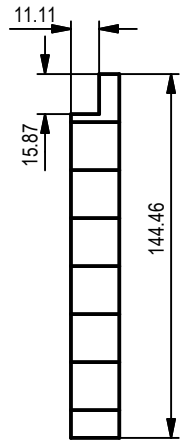

PROJEKT <b>Bienenbeute</b>	ERSTELLT VON A. PARDO	GENEHMIGT VON		
TEIL-NAME SHALLOW SUPER	TEIL-CODE 5	DOKUMENTTYP ASSEMBY	WERKSTOFF WOOD	
 OPEN SOURCE ECOLOGY GERMANY	LIZENZ 	DATEI-NAME SHALLOW SUPER.iam	VERSION 1.0	MENGE 1
		SCALE 1 : 4.5	SEITE 20/28	DATE 25-09-2020



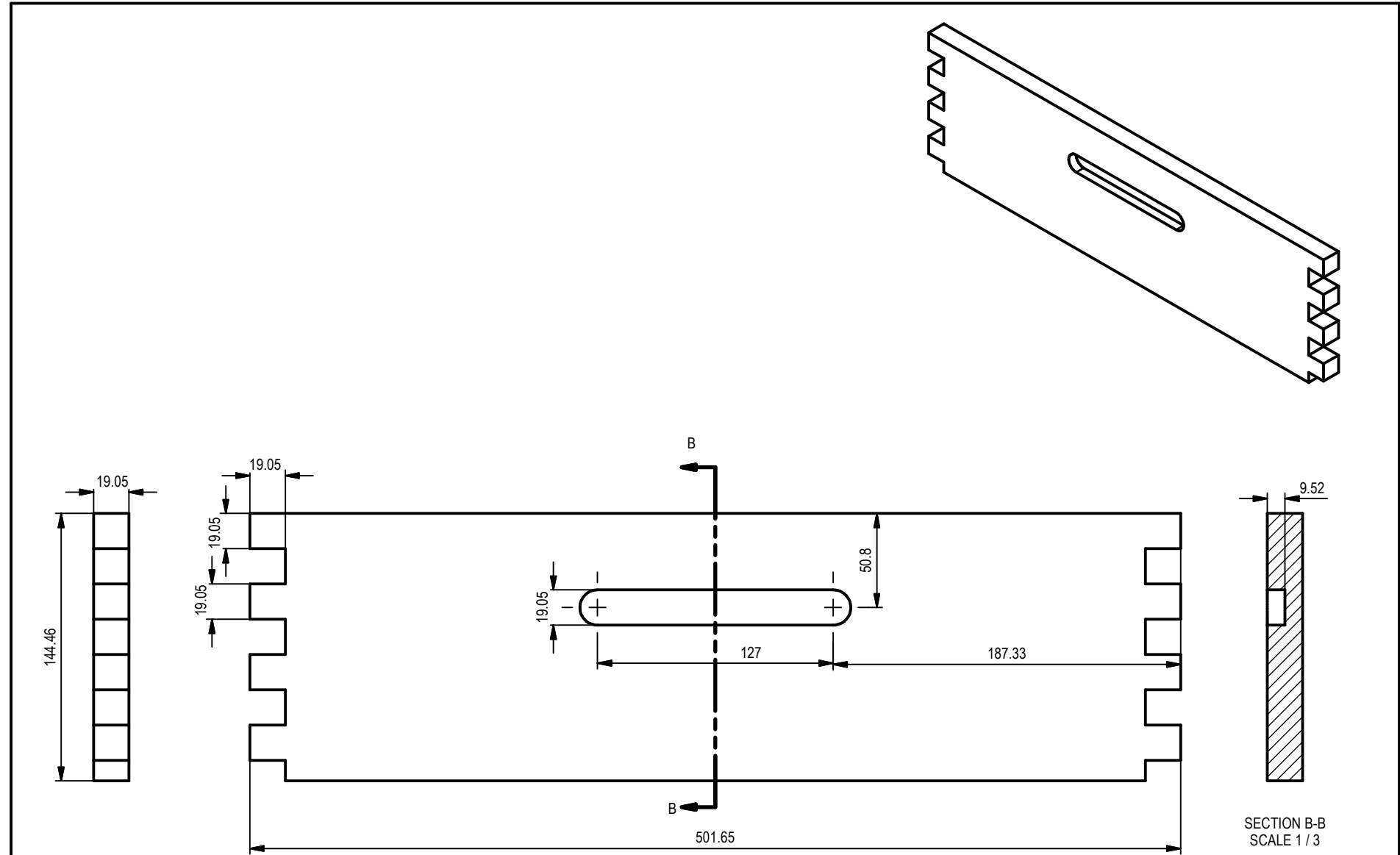

SECTION ME-ME  
SCALE 1 / 3

PROJEKT <b>Bienenbeute</b>	ERSTELLT VON A. PARDO	GENEHMIGT VON		
TEIL-NAMEN SHALLOW SUPER A	TEIL-CODE 5.1	DOKUMENTTYP ASSEMBY	WERKSTOFF WOOD	
	LIZENZ 	DATEI-NAMEN SHALLOW SUPER A.ipt	VERSION 1.0	MENGE 1
		SCALE 1 / 3	SEITE 21/28	DATE 25-09-2020



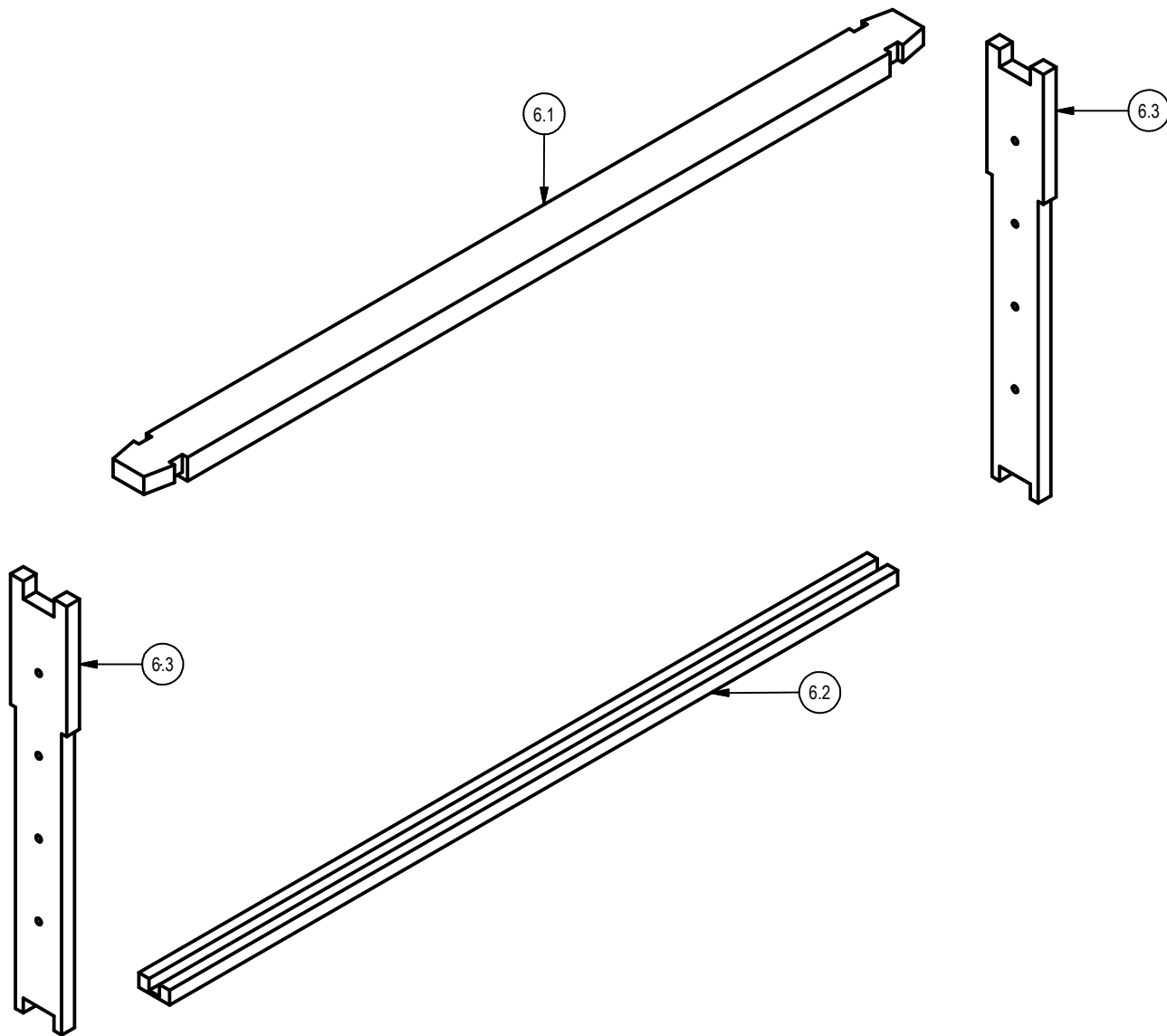

PROJEKT <b>Bienenbeute</b>	ERSTELLT VON A. PARDO	GENEHMIGT VON		
TEIL-NAME SHALLOW SUPER B	TEIL-CODE 5.2	DOKUMENTTYP ASSEMBY	WERKSTOFF WOOD	
 <small>OPEN SOURCE ECOLOGY GERMANY</small>	LIZENZ 	DATEI-NAME SHALLOW SUPER B.ipt	VERSION 1.0	MENGE 1
		SCALE 1 / 3	SEITE 22/28	DATE 25-09-2020



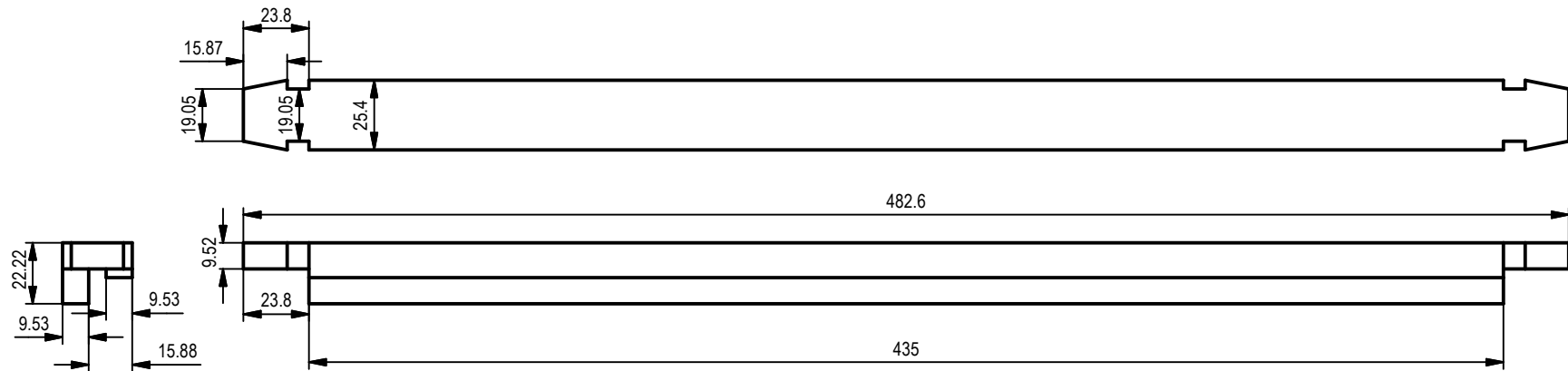
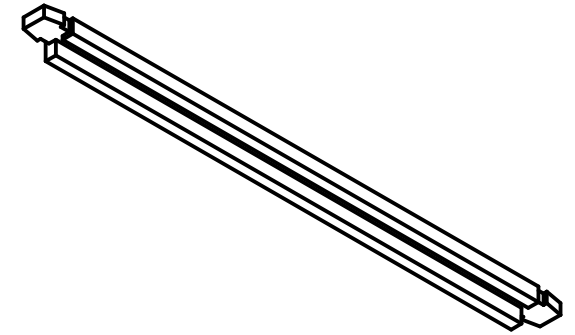

PROJEKT <b>Bienenbeute</b>	ERSTELLT VON A. PARDO	GENEHMIGT VON		
TEIL-NAME BROOD FRAME	TEIL-CODE 6	DOKUMENTTYP ASSEMBY	WERKSTOFF WOOD	
 <small>OPEN SOURCE ECOLOGY GERMANY</small>	LIZENZ 	DATEI-NAME BROOD FRAME.iam	VERSION 1.0	MENGE 1
		SCALE 1 : 3	SEITE 23/28	DATE 25-09-2020



PROJEKT <b>Bienenbeute</b>	ERSTELLT VON A. PARDO	GENEHMIGT VON		
TEIL-NAME BROOD FRAME A	TEIL-CODE 6.1	DOKUMENTTYP ASSEMBY	WERKSTOFF WOOD	
 <small>OPEN SOURCE ECOLOGY GERMANY</small>	LIZENZ 	DATEI-NAME BROOD FRAME A.ipt	VERSION 1.0	MENGE 1
		SCALE 1 / 2.5	SEITE 24/28	DATE 25-09-2020

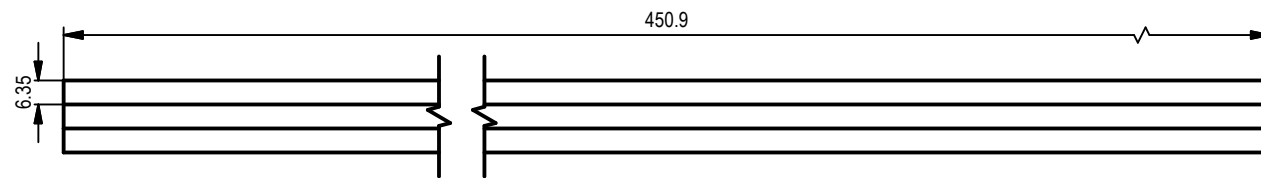
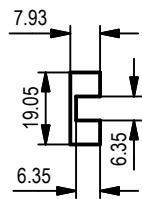
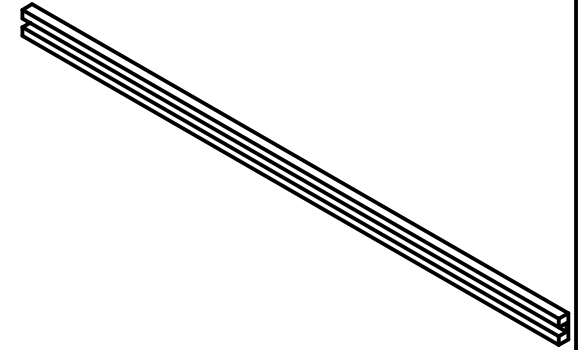



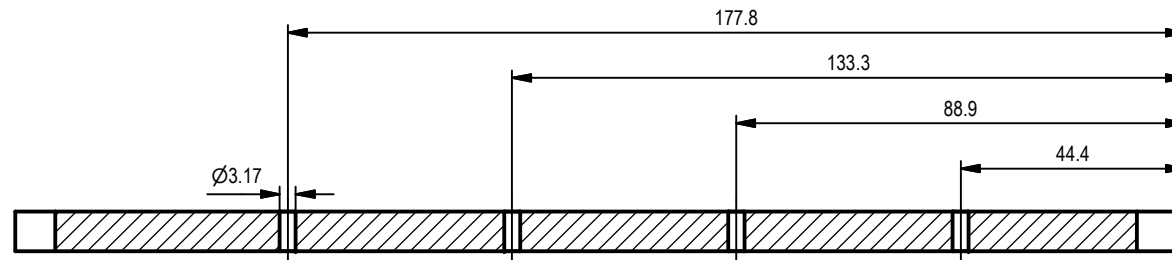
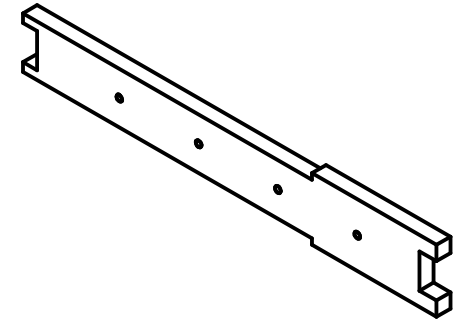

PROJEKT <b>Bienenbeute</b>	ERSTELLT VON A. PARDO	GENEHMIGT VON		
TEIL-NAME BROOD FRAME B	TEIL-CODE 6.2	DOKUMENTTYP ASSEMBY	WERKSTOFF WOOD	
	LIZENZ 	DATEI-NAME BROOD FRAME B.ipt	VERSION 1.0	MENGE 1
		SCALE 1 / 2	SEITE 25/28	DATE 25-09-2020

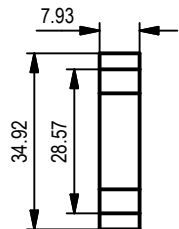
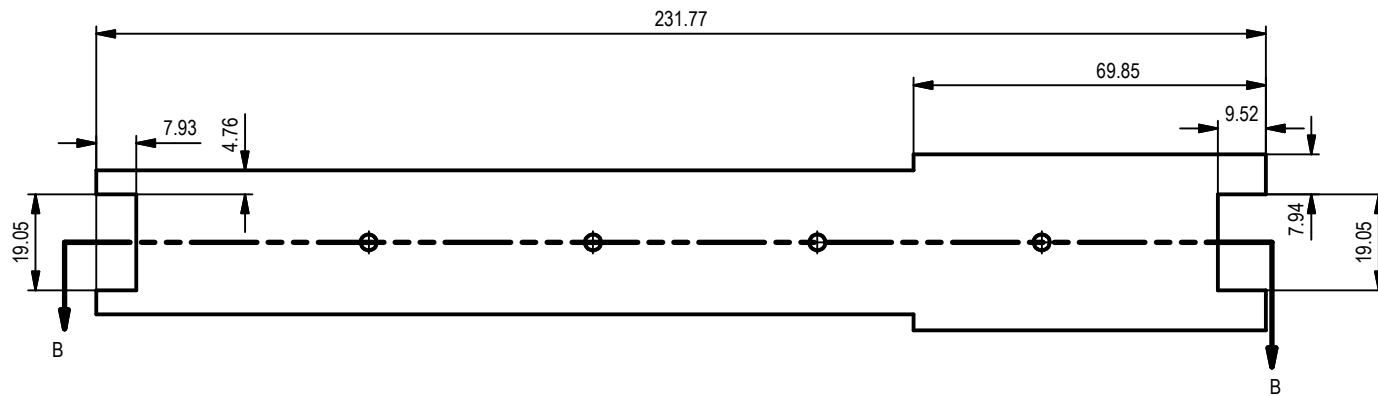

SECTION B-B  
SCALE 1 / 1.5



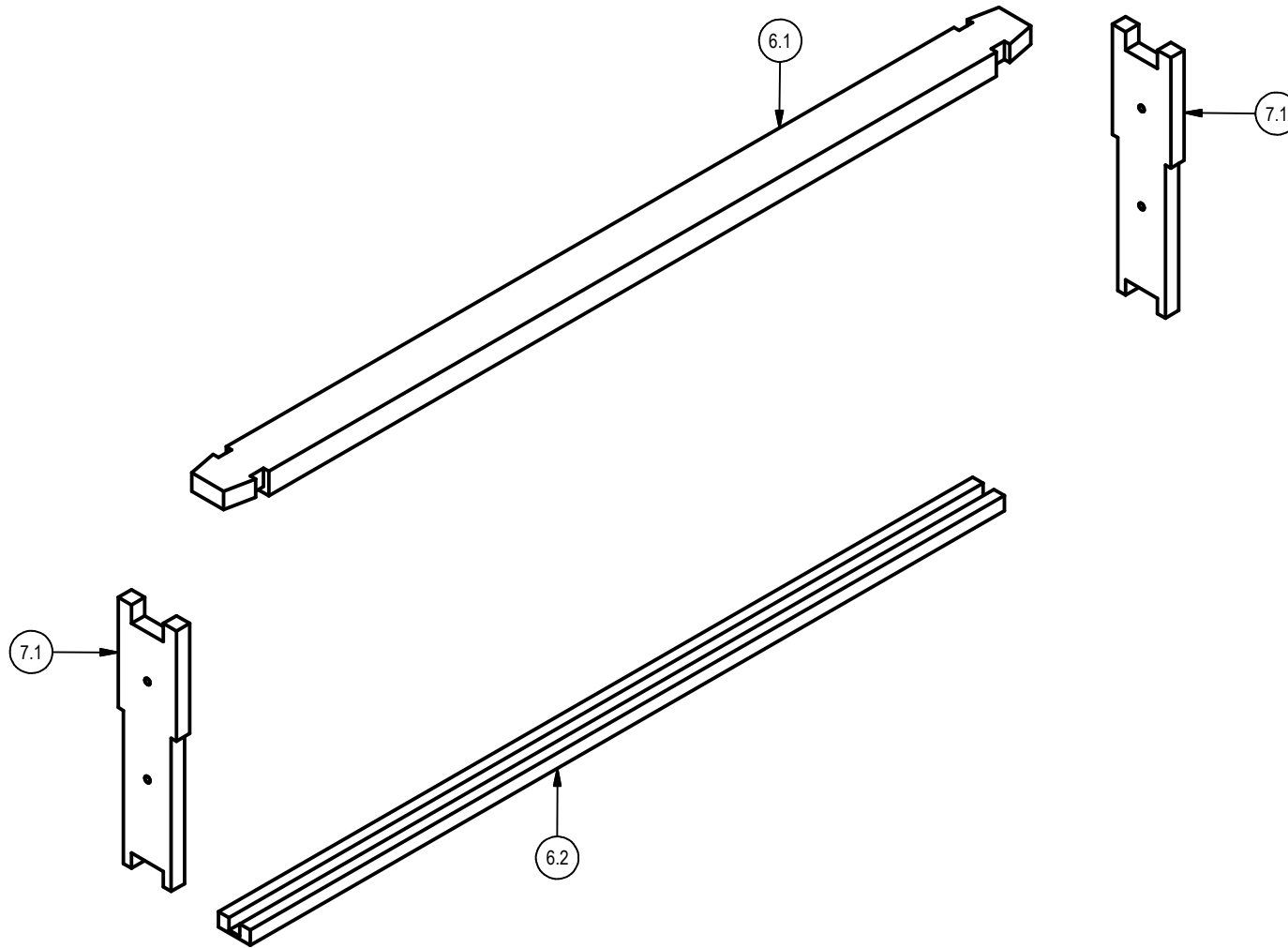

PROJEKT <b>Bienenbeute</b>	ERSTELLT VON A. PARDO	GENEHMIGT VON		
TEIL-NAMEN BROOD FRAME C	TEIL-CODE 6.3	DOKUMENTTYP ASSEMBY	WERKSTOFF WOOD	
 OPEN SOURCE ECOLOGY GERMANY	LIZENZ 	DATEI-NAMEN BROOD FRAME C.ipt	VERSION 1.0	MENGE 1
		SCALE 1 / 1.5	SEITE 26/28	DATE 25-09-2020

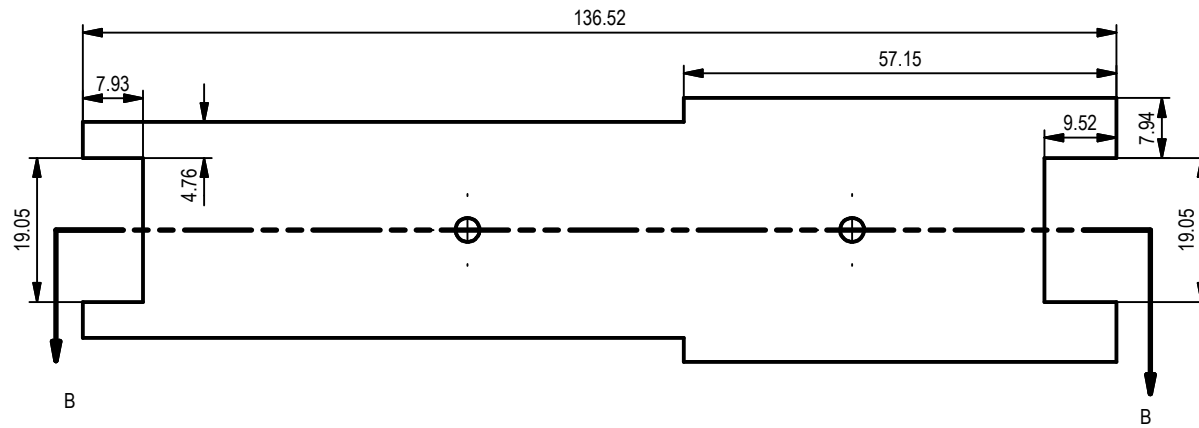
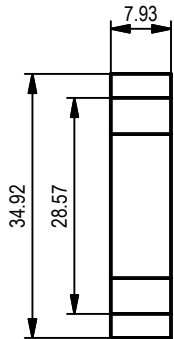
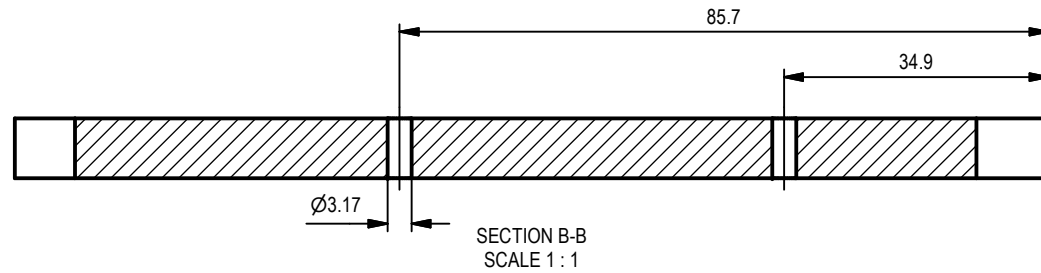
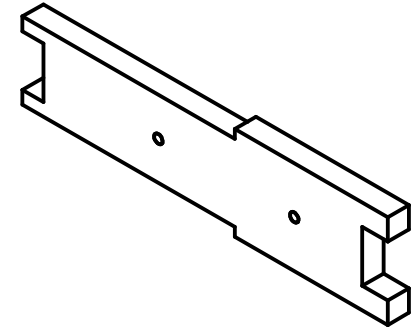

PROJEKT <b>Bienenbeute</b>	ERSTELLT VON A. PARDO	GENEHMIGT VON		
TEIL-NAME SHALLOW SUPER FRAME	TEIL-CODE 7	DOKUMENTTYP ASSEMBY	WERKSTOFF WOOD	
 <small>OPEN SOURCE ECOLOGY GERMANY</small>	LIZENZ	DATEI-NAME SHALLOW SUPER FRAME.iam	VERSION 1.0	MENGE 1
			SCALE 1 / 3	SEITE 27/28



PROJEKT <b>Bienenbeute</b>	ERSTELLT VON A. PARDO	GENEHMIGT VON		
TEIL-NAME SHALLOW SUPER FRAME A	TEIL-CODE 7.1	DOKUMENTTYP ASSEMBY	WERKSTOFF WOOD	
 OPEN SOURCE ECOLOGY GERMANY	LIZENZ 	DATEI-NAME SHALLOW SUPER FRAME A.ipt	VERSION 1.0	MENGE 1
		SCALE 1:1	SEITE 28/28	DATE 25-09-2020