







PROJECT		CREATED BY	APPROVED BY	DATE	VERSION
Cross Flow Turbine		D.MOSQUERA	D. JAEGER	05-04-21	1.0
PART NAME		FILE NAME			PART CODE
Base frame		oseg_cft_Base-frame.iam			1.0
DEVELOPED BY	REDESIGNED BY	SUPPORTED BY	DOC. TYPE	MATERIAL	QUANTITY
			ASSEMBLY		1
			LICENCE	SCALE	SHEET
			CC.BY.SA 4.0	1:10	9 /90

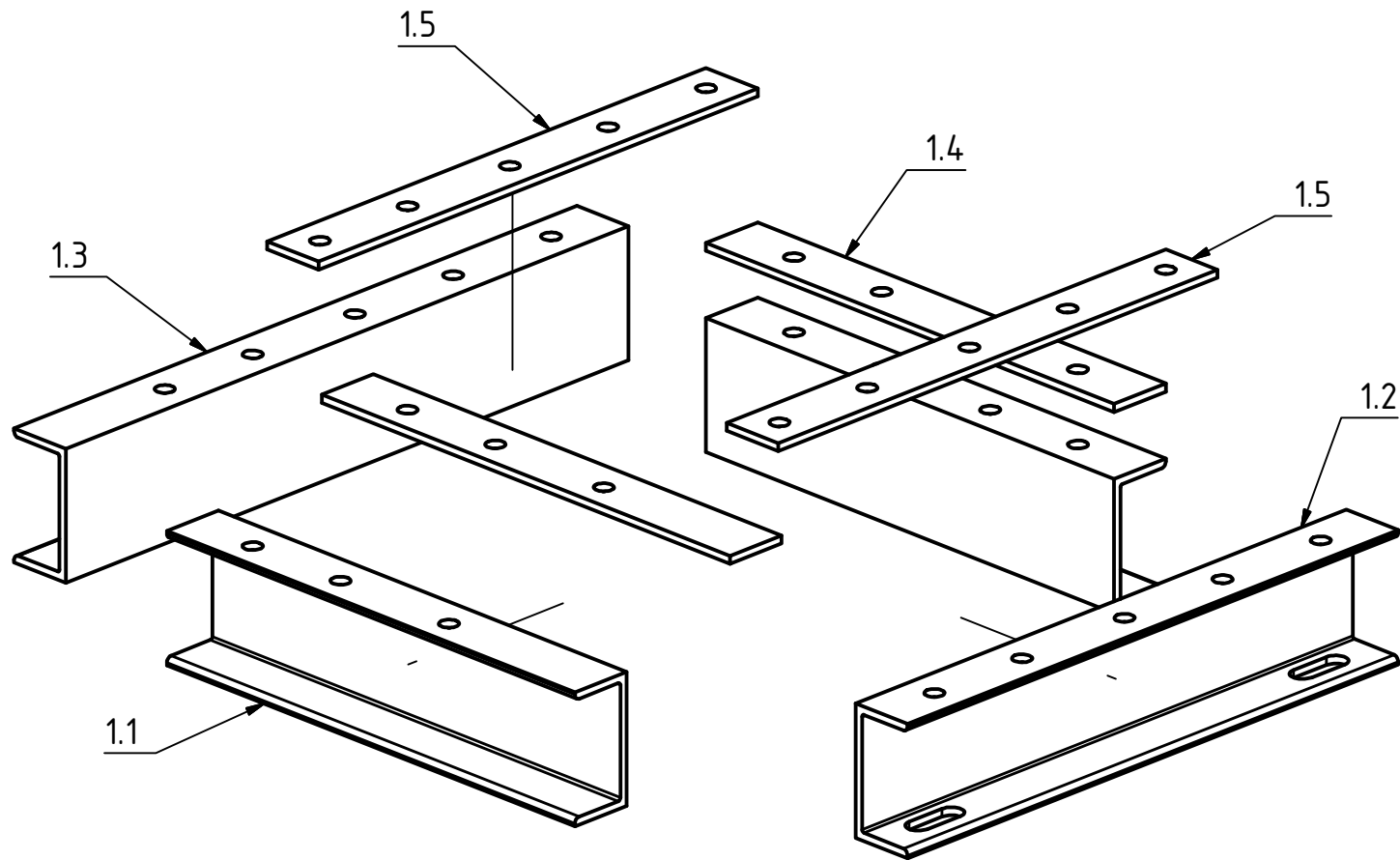

PROJECT		CREATED BY		APPROVED BY		DATE		VERSION	
Cross Flow Turbine		D.MOSQUERA		D. JAEGER		05-04-21		1.0	
PART NAME				FILE NAME				PART CODE	
Base frame				oseg_cft_Base-frame.ipn				1	
DEVELOPED BY		REDESIGNED BY		SUPPORTED BY		DOC. TYPE		MATERIAL	
						PART LICENCE		QUANTITY	
				CC.BY.SA 4.0		SCALE		SHEET	
						1:5		10 /90	