







PROJECT		CREATED BY	APPROVED BY	DATE	VERSION
Cross Flow Turbine		D.MOSQUERA	D. JAEGER	05-04-21	1.0
PART NAME		FILE NAME			PART CODE
Cross flow turbine		oseg_cft_A1_Cross-flow-turbine.iam			A1
DEVELOPED BY	REDESIGNED BY	SUPPORTED BY	DOC. TYPE	MATERIAL	QUANTITY
	 OPEN SOURCE ECOLOGY GERMANY	 STIFTUNG	ASSEMBLY		1
	OSEG		LICENCE	SCALE	SHEET
			CC.BY.SA 4.0	1:7	1 /90

A-A (1 : 8)

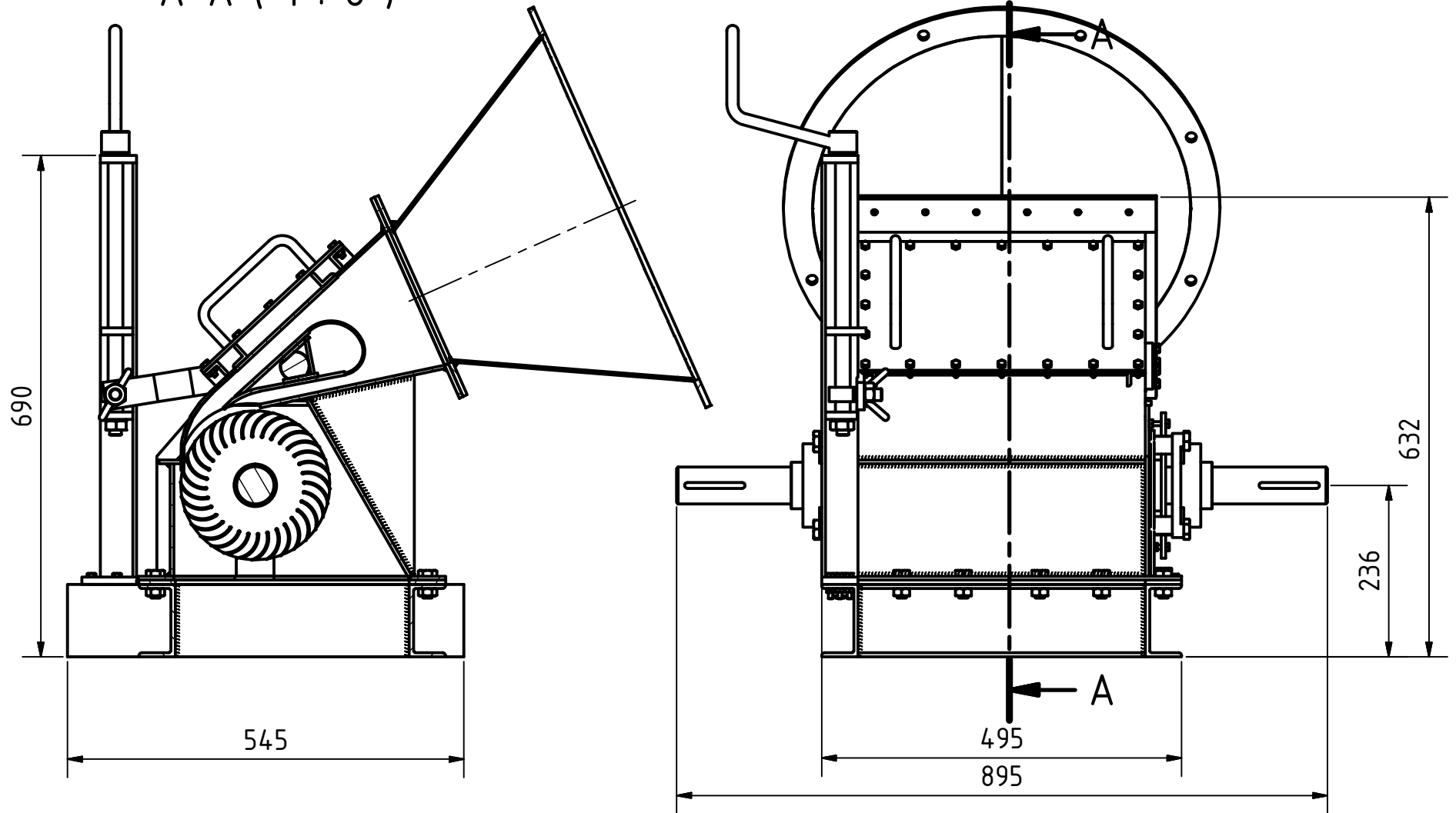

PROJECT		CREATED BY		APPROVED BY		DATE		VERSION	
Cross Flow Turbine		D.MOSQUERA		D. JAEGER		05-04-21		1.0	
PART NAME		FILE NAME						PART CODE	
Cross flow turbine		oseg_cft_A1_Cross-flow-turbine.iam						A1	
DEVELOPED BY		REDESIGNED BY		SUPPORTED BY		DOC. TYPE		MATERIAL	
		 OPEN SOURCE ECOLOGY GERMANY OSEG				ASSEMBLY			
						LICENCE		SCALE	
						CC.BY.SA 4.0		1:8	
								QUANTITY	
								1	
								SHEET	
								2 /90	